

EXPERIMENTAL STUDY OF PLASMOIDS

WINSTON H. BOSTICK*

University of California Radiation Laboratory, Livermore, California, U.S.A.

ABSTRACT

A plasma source can be used to project ionized matter across a magnetic field. The configuration of plasma observed when an electromagnetic braking action is produced by the presence of low-pressure gas (about 1μ) in the vacuum chamber provides an insight into the manner in which magnetic-field lines can be dragged and twisted. By firing several sources simultaneously, it is possible to simulate the production of spiral galaxies and barred spirals. The paper presented here forms an extension of earlier experiments performed by the author on plasmoids [1].

I. PRODUCTION OF A PLASMOID IN
FIELD-FREE SPACE*(a) The π_1 plasmoid*

It has not only been demonstrated [2,3] that plasma can be projected from a plasma gun or plasma source with speeds up to 2×10^7 cm/sec, but the experimental observations suggest that the plasma travels (even in field-free space) not as an amorphous blob, but as a structure (called a plasmoid) whose form is determined by the magnetic field it carries along with itself. The mechanism whereby the plasma is propelled from the source has already [2] been outlined, and the hypothesis that the plasma travels in field-free space in the form of a torus has been supported with a Kerr-cell picture of the plasma in a toroidal form leaving the source.

The probe traces shown in Plate I (a) and (b) are further evidence that the projected plasma has structure. The exact structure of the plasma cannot be accurately delineated from these probe traces, but at least the probe traces are consistent with the hypothesis that the plasma is in the form of a torus. It is unfortunate, from the observational point of view, that these plasmoids move so rapidly. If they could be produced so that their center of mass was stationary in the laboratory, they could be photographed much more easily. (Later in this paper there will be described stationary

* Now at Stevens Institute of Technology, Hoboken, N. J., U.S.A.

plasmoids formed in a magnetic field which definitely exhibit toroidal structure.)

It has been possible with a magnetic coupling loop to pick up signals which are believed to be associated with the magnetic fields trapped by the plasmoid of the type shown in Figs. 2, 3, and 4 in Reference [2]. (Note that no external D.C. magnetic field is employed here.) Examples of such signals are shown in Plate II. Although the structure of these signals is too complex for analysis, these signals are nevertheless experimentally identified with the magnetic fields carried by the plasmoid.

In the magnetic coupling loop-signals, as with the probe signals, the outstanding feature is the steep leading edge, which can in no way be associated with an ordinary shock wave. The steepness of this leading edge of the plasmoid may possibly explain the abrupt onset of magnetic storms approximately 24 hr after a solar disturbance. It is entirely possible that ions and electrons ejected from the sun come to the earth in the form of a plasmoid.

In fact if a probe is immersed in a local magnetic field (e.g. due to a bar magnet) and a plasma source is fired at the probe at 1 m distance, the signal from the probe not only has a steep leading edge, but it exhibits large irregular oscillations which indicate rapidly varying ion densities and electric fields produced by the plasma encountering the stationary magnetic field.

The type of plasmoid (to be designated the π_1 plasmoid, because it is unstable) diagrammed in Fig. 4 of Reference [2] is expected to expand in directions of both increasing R and r , which are respectively the large and small radii of the torus. If m_T is the total mass of the plasmoid in grams and I is the total circulating current in amperes, an approximate differential equation (with the neglect of the logarithmic term) is

$$m_T d^2R/dt^2 = 8I^2/50\pi. \quad (1)$$

If at $t=0$ the original flux $\phi_0 \approx 2\pi^2 I_0 R_0/5$, where I_0 and R_0 are the initial current and radius, and $dR/dt=0$, the solution is given by

$$R_0 \sqrt{(R(1 + R/R_0)) - 1/2 R_0^{3/2} \ln [(\sqrt{(1 + R/R_0)} + \sqrt{(R/R_0)})/\sqrt{R_0}] - R_0^{3/2} [\sqrt{(2)} - 1/2 \ln \{(\sqrt{(2)} + 1)/\sqrt{R_0}\}] \cong \sqrt{(2\gamma t)}, \quad (2)$$

where

$$\gamma \equiv 8I_0^2 R_0^2/50\pi m_T.$$

From this solution it can be seen that when $R/R_0 \gg 1$, $R \sim t$. The expected expansion of the π_1 plasmoid may thus be thought of as a magnetic explosion where most of the outward velocity is picked up when the plasmoid is small.

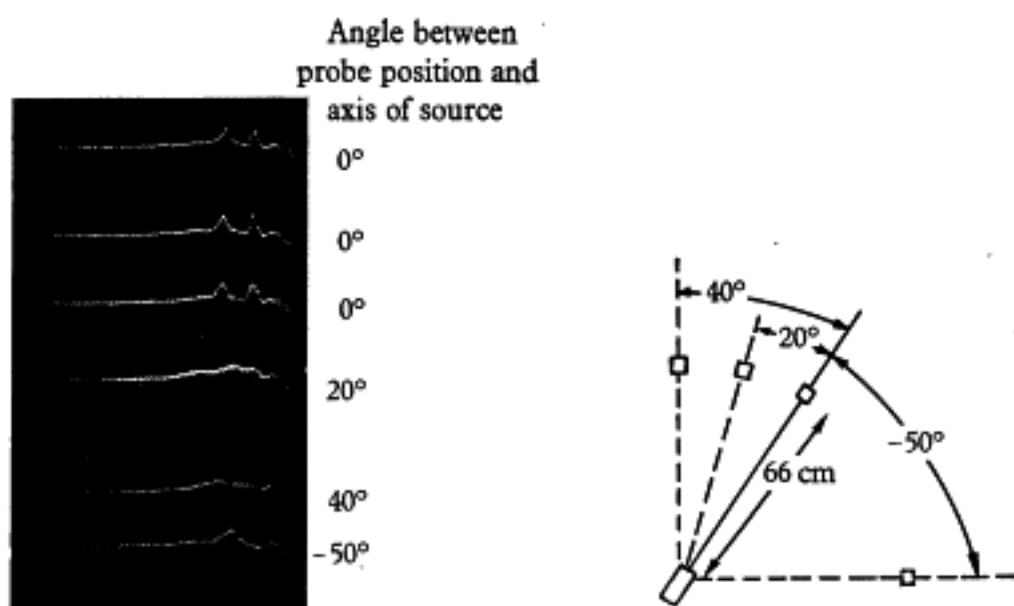

(a)

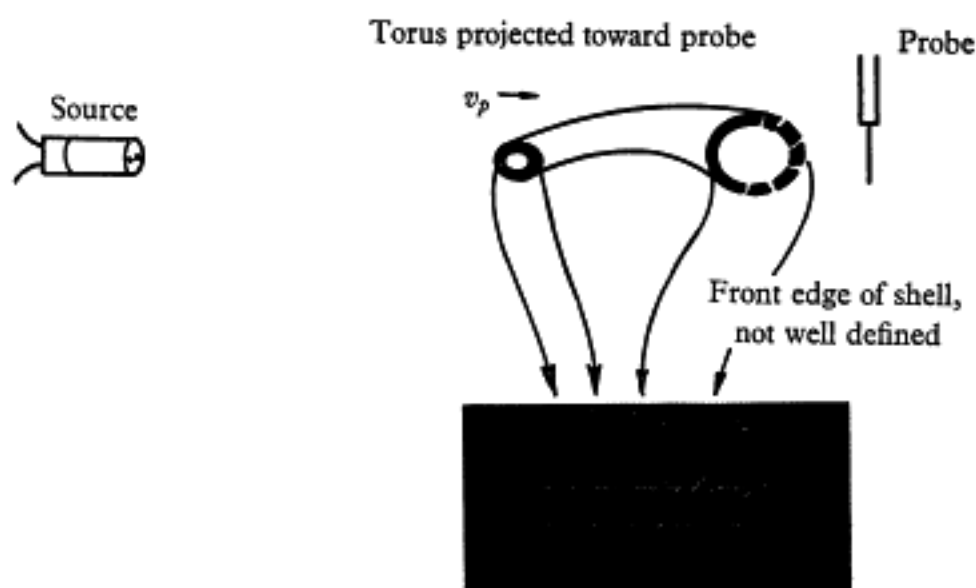

(b)

Plate I (a). Probe tracks taken with alnico bar-magnet probes at 66 cm from the source of plasma at the various angles shown. The peak current in the source is about 3000 amperes. The sweep speed is $5 \mu\text{sec}/\text{cm}$. Time goes from right to left and the source is fired at the beginning of the trace. The alnico bar-magnet is $1 \times 1 \times 2$ cm.

(b) Probe traces taken at a distance of 10 cm from the source at sweep speeds of $0.5 \mu\text{sec}/\text{cm}$. Sensitivity is $15 \text{ v}/\text{cm}$. The signal is developed across a 50-ohm resistance to ground. The probe is 1 mm in diameter and 2 cm long. Time goes from right to left and the trace starts at the firing of the source. An attempt has been made to identify the various parts of the hypothesized torus with the portions of the $0.5 \mu\text{sec}/\text{cm}$ trace.

(facing p. 88)

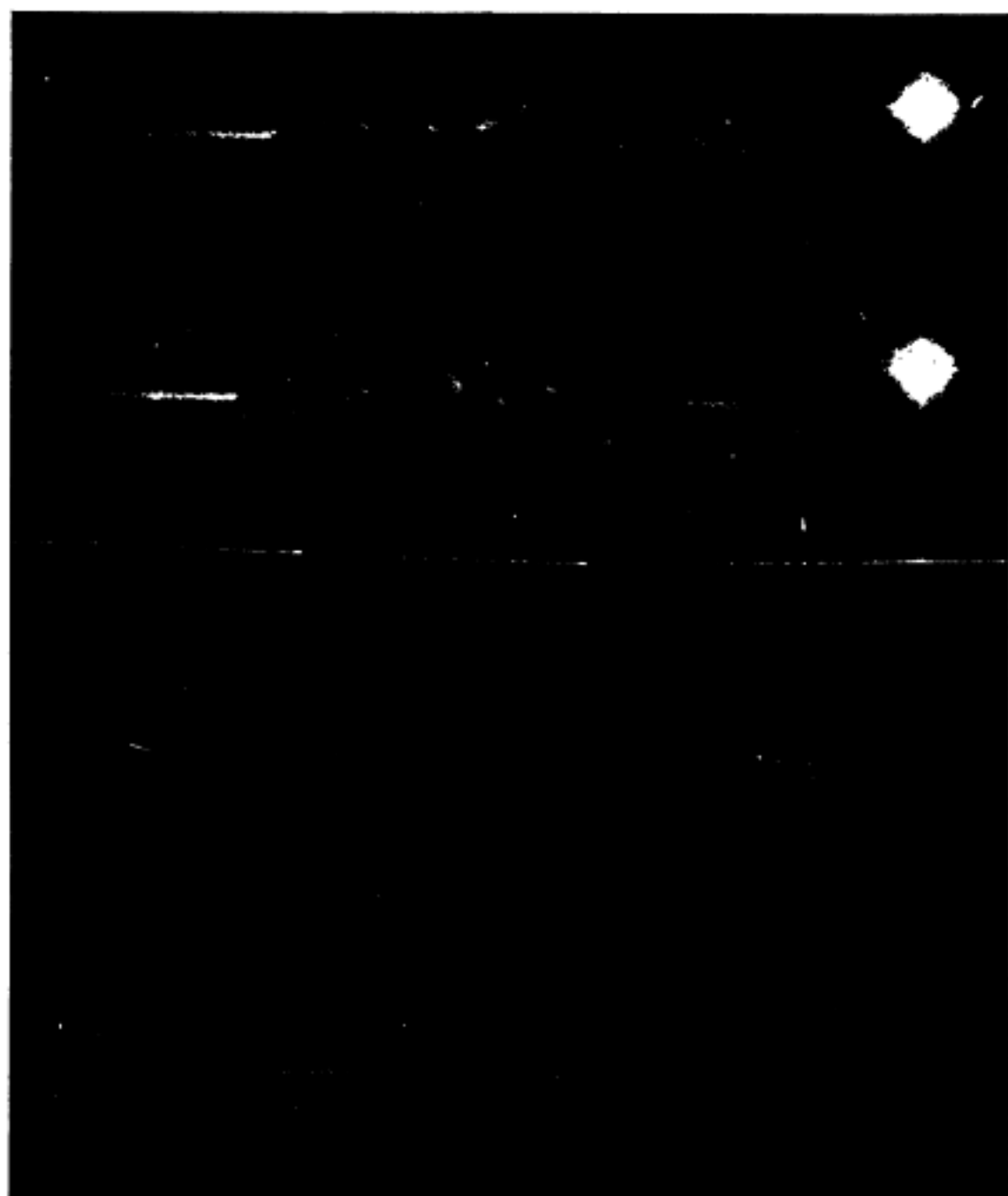

Plate II. Signals from a one-turn, 0.64 cm diameter coupling loop terminated with 50 ohms, where there is no external magnetic field applied. The coil is oriented in the plane of the paper, with respect to the source shown in Fig. 2., Reference [1], and located 10 cm directly in front of the source. The sensitivity is 0.5 volt/cm. The sweep speed is 0.5 μ sec/cm, with the time going from right to left. The first two traces represent the current in one direction of the source, the second two traces represent the current in the opposite direction. The true plasma signals arrive at the loop at a time of about 1.3 μ sec after the firing of the source which triggers the sweep. These signals are an indication of trapped magnetic fields within the plasma.

(b) *The S-plasmoid*

It is possible to conceive of a plasmoid which at first sight seems to be more stable than the π_1 plasmoid. This plasmoid, which we shall designate the *S-plasmoid*, is diagrammed in Fig. 1. Conceivably this plasmoid could be produced by winding a thin metallic ribbon into a helix and then bending the helix into a torus. If the metallic ribbon is then suddenly energized with a current so that it is vaporized and ionized, there presumably would be formed the *S-plasmoid*. Though this method of producing the *S-plasmoid* in field-free space would be tedious, it might nevertheless be fruitful and should eventually be tried.

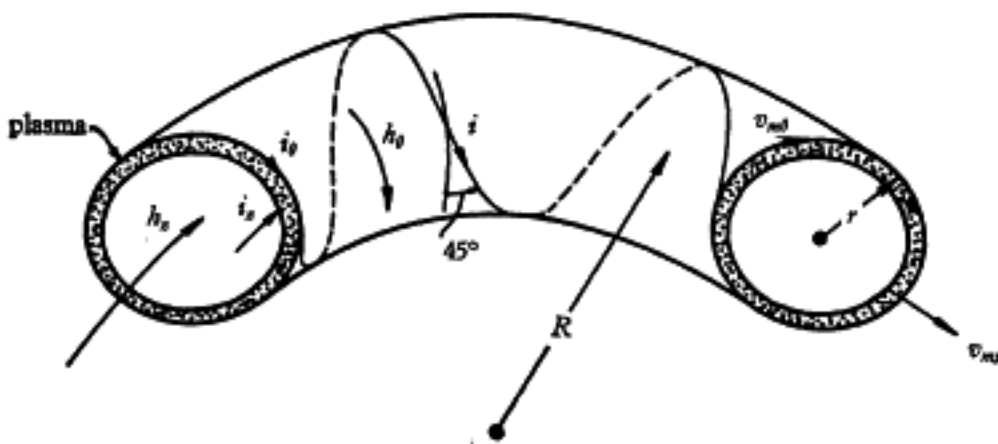

Fig. 1. The *S-plasmoid*. This configuration of magnetic field and plasma is essentially the same as that of the *H*-centered pinch in a toroidal tube which was first proposed and investigated experimentally in the United States in 1955 by M. A. Levine and L. S. Combes [Tufts University, Dept. of Physics Report, January 30, 1956 (unpublished)]. The configuration has since received theoretical development by M. N. Rosenbluth and C. L. Longmire [*Annals of Physics*, **1**, 120, 1957]. Papers 47-49 of this volume are reports on experimental and theoretical work on the same configuration in a straight tube (see also I. N. Golovin *et al.*, *J. Atomic Energy U.S.S.R.*, **5**, 26, 1956; V. D. Shafranov, *J. Atomic Energy U.S.S.R.*, **5**, 38, 1956).

From the theoretical point of view let us briefly examine the *S-plasmoid* in field-free space (i.e. no external d.c. magnetic field) and see if it is stable.

If we neglect the effects of nkT and centripetal acceleration due to any rotary motions of the mass of plasma, we note that equilibrium about r (see Fig. 1) requires that

$$h_z = h_\theta \quad \text{or that} \quad i_z = i_\theta.$$

Then since
$$i_z = 2\pi r i_z \quad \text{and} \quad I_\theta = 2\pi R i_\theta,$$

$$I_\theta / I_z = R / r.$$

Let us assume that at time $t=0$, the initial current $I_z = I_\theta$, and that the plasma is such a good conductor so that for all subsequent time the initial

magnetic fluxes ϕ_z and ϕ_θ will be preserved. For purposes of simplification, electromagnetic units are used here. Then

$$\begin{aligned}\phi_z &= L_z I_z = 4\pi R[\ln(8R/r) - 2] I_z \\ &= L_{z0} I_0 = 4\pi R[\ln(8R_0/r_0) - 2] I_0\end{aligned}\quad (3)$$

and
$$W_z = (1/2) L_z I_z^2 = 2\pi R[\ln(8R/r) - 2] I_z^2 \quad (4)$$

Also,
$$\phi_\theta = L_\theta I_\theta - 2\pi r^2 I_0/R = 2\pi r^2 R I_z/Rr = 2\pi r I_z \quad (5)$$

$$= L_{\theta 0} I_{\theta 0} = 2\pi r_0 I_0 \quad (6)$$

and
$$W_\theta = 1/2 L_\theta I_\theta^2 = 1/2 2\pi r^2 I_\theta^2/R = \pi R I_z^2 \quad (7)$$

Now let us note that if ϕ_z and ϕ_θ are constant, $\alpha \equiv \phi_z/\phi_\theta$ must remain constant, and

$$\phi_z/\phi_\theta = 2R/r[\ln(8R/r) - 2].$$

Hence, preservation of flux ϕ_z and ϕ_θ requires that R/r be a constant.

The total energy

$$\begin{aligned}W_T &= W_z + W_\theta = 1/2 \phi_z^2/L_z + 1/2 \phi_\theta^2/L_\theta \\ &= 1/2 \phi_z^2 \{1/4\pi R[\ln(8R/r) - 2] + R/2\pi r^2 \alpha^2\} \\ &= (\phi_z^2/4\pi R) \{r/2R[\ln(8R/r) - 2] + R/r\alpha^2\}.\end{aligned}\quad (8)$$

Now the force which will expand the S -plasmoid, and yet preserve the fluxes ϕ_z and ϕ_θ and hence R/r , is

$$-\left(\frac{\partial W_T}{\partial r}\right)_{R/r} = (\phi_z^2/4\pi r^2) \{r/2R[\ln(8R/r) - 2] + R/r\alpha^2\}.\quad (9)$$

This force is to be compared with the force which expands only the π_1 -plasmoid:

$$-\left(\frac{\partial W_s}{\partial R}\right)_{\theta_s} = \phi_z^2/8\pi R^2[\ln(8R/r) - 2].\quad (10)$$

Eqs. (9) and (10) give the somewhat unexpected result that for all values of $R/r \geq 1$ we have $\left|\frac{\partial W_T}{\partial r}\right| > \left|\frac{\partial W_s}{\partial R}\right|$, and hence the S -plasmoid should actually expand faster than the π_1 -plasmoid.

It is interesting to note that for $W_s = W_\theta$, $\phi_z = \phi_\theta$ (i.e. where stability might possibly occur) the corresponding value of R/r is 1.0. Unfortunately, the formulae used for L_z , ϕ_z , and W_z do not hold below $R/r \geq 2.5$. It is further interesting to note that for $R/r = n$, where n is an integer, a current streamline will coincide cyclically with itself after one complete revolution of the plasma. And since R/r is a constant, the preservation of $R/r = n$ amounts to a kind of macroscopic quantum condition.

It is possible to plot W_T as a function of R for various values of r . The minima of these curves represent the situation where $W_\theta = W_z$, $\phi_\theta = \phi_z$, $\alpha = 1.0$, and $R/r = 1.0$. The expansion of the S -plasmoid will presumably occur along the minima of the curves and in the direction of increasing r . However, the portions of the curves to the left of the minima have no meaning because here $R/r < 1$. Hence, any realizable conditions involve a trajectory considerably to the right of the minima. It will be necessary to make the computation with expressions for L_z and L_θ which hold for values of R/r which are close to 1.

Furthermore, the stability relationships should be examined for configurations (like a muff) where the cross-section of the S -plasmoid is not circular, but oblong.

This brief analysis suggests that the S -plasmoid is unstable, but it cannot be stated definitely that all shapes of S -plasmoids in field-free space are unstable. There is a very real possibility that the S -plasmoid immersed in an external D.C. magnetic field would be stable.

2. PRODUCTION OF PLASMOIDS IN A MAGNETIC FIELD

(a) *Introduction*

It has already been demonstrated^[2,3] that plasmoids can be projected across a magnetic field. It is quite possible that ionized material ejected from the surface of the sun proceeds and escapes across the magnetic field of the sun in the same manner that laboratory-produced plasmoids cross a magnetic field.

Plasmoids produced in a good vacuum are elongated cylinders^[2,3] which travel as a wave front of constant velocity across the magnetic field. These plasmoids bear very little resemblance to the S -plasmoid and move so rapidly as to make instantaneous photography very difficult if not impossible. However, these plasmoids leave a wake or track^[2] which enables us to photograph their path quite easily.

It is further observed^[2] that these plasmoids experience an electromagnetic braking action which decelerates and deflects them when they encounter one another or when they travel through gas at a pressure of about 1μ . Indeed, several of these plasmoids can be made to spiral^[2] in consort to produce a ring of plasma. The organic relation between this laboratory-observed process and the evolution of spiral galaxies and stars has already been suggested. More recent measurements^[4] with a Kerr cell portray a time-sequence in the formation of this torus or ring, and show that

not only is the torus produced automatically, but also that it is stationary, i.e. with regard to translation, and stable over a period of at least $30 \mu\text{sec}$. During this time the torus appears to retain a circular form of about the same large and small radii.

There is some temptation to identify this observed⁽²⁾ torus with the *S*-plasmoid immersed in a magnetic field. Before succumbing to this temptation, let us examine the results of some more recent measurements which teach us the prudent lesson that somehow we must learn to understand the way in which magnetic-field lines are dragged, spun, and interwoven if we are to give an adequate description of the resultant plasma configurations.

(b) *Barred spirals*

One of the simplest (relatively, that is) results which must be understood is the 'barred spiral'⁽⁴⁾ which is produced by firing two sources at one another across a magnetic field. Over a wide range of variation of parameters the two plasmoids seem to seek each other out unerringly. The sequential stereo photographs of Plate III show the process of production of these 'barred spiral' structures at a pressure of 2μ .

It can be seen from Plate III that the leading edges of the two plasmoids seem to seek each other and latch on to one another. The same process can be observed in Plate IV, where the pressure is 1μ , where the bond between the two plasmoids apparently does not hold as well as in Plate III. The photographs of Plate IV also show the interesting feature that the tails of the spiral arms become forked.

Plate V shows a sequence of photographs where the pressure is 4μ and where the leading edges of the plasmoids are positioned by the twisting of the plasmoids so that they are in no position to attach to one another. Under these circumstances the two plasmoids press tightly against one another but remain separated for at least $6 \mu\text{sec}$. In Plate VI (a) where the pressure is 6μ , the plasmoids remain separated for at least $10 \mu\text{sec}$. Furthermore, the stereo photographs of Plates III, IV, V and VI (a) show that the plasmoid in proceeding across the magnetic field at these fairly high pressures assumes the form of a helix of progressively increasing diameter.

The photographs of Plates III, IV, V and VI (a) give us enough information to suggest that the configuration of plasma and magnetic field when one plasma source is fired across a magnetic field is that shown in Fig. 2. Eventually it may be possible to analyze this process quantitatively. For the moment, a description by a drawing will have to suffice.

It is now possible to see how two plasmoids fired at one another across a magnetic field can latch on to one another, as shown in Fig. 3. Such a

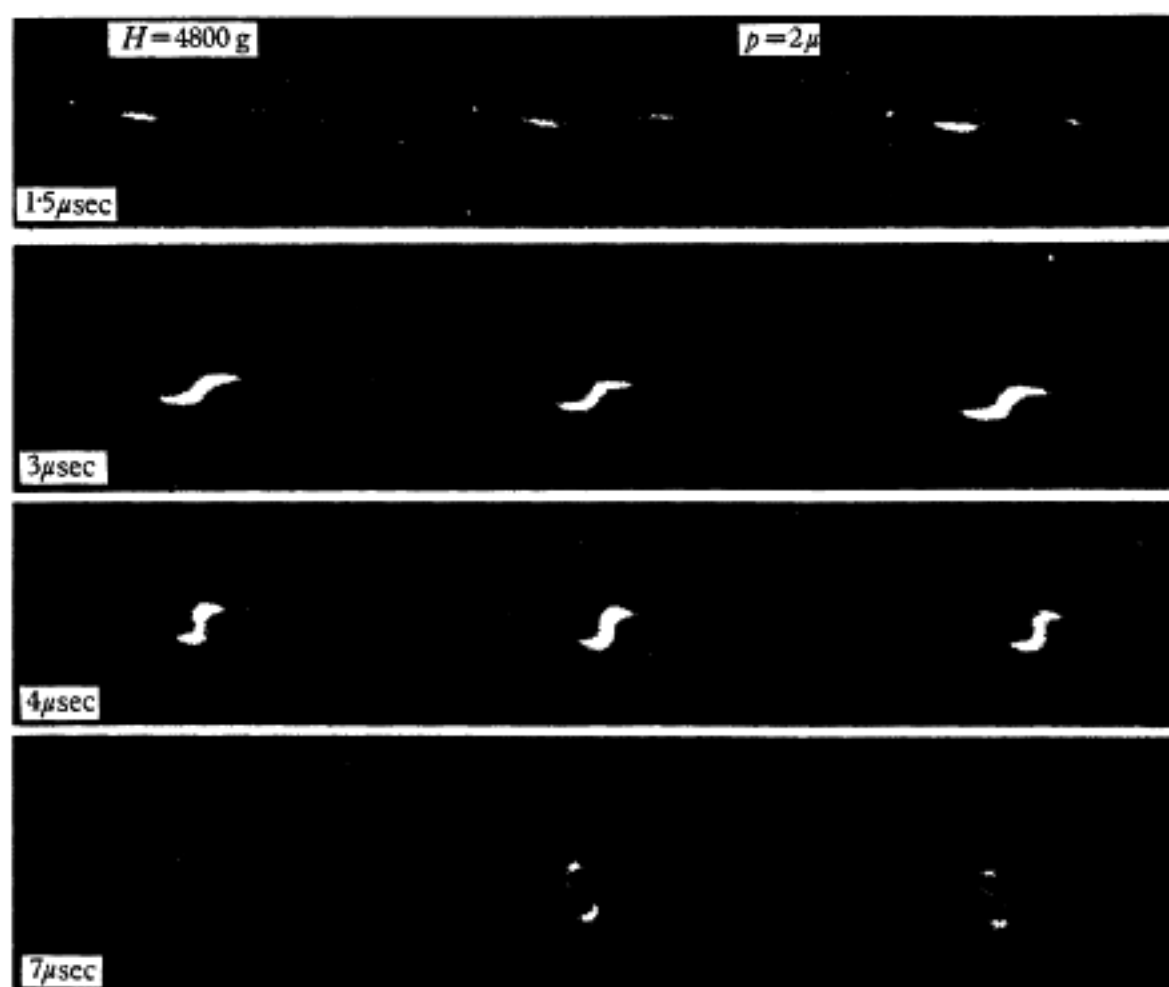

Plate III. A sequential study of barred spirals which are produced by firing two plasmoids from sources 10 cm apart at one another simultaneously across a magnetic field of 4800 gauss. The Kerr cell exposure times are $2 \mu\text{sec}$ and the various delay times of the sequence are indicated in μsec . The pressure in the chamber is 2μ . The plasmoids and their trajectories are rendered luminous primarily by the recombination light of the titanium and deuterium ions which come from the plasma source. The photographs on the left are the left stereo photos and those on the right, the right stereo photos, with an angle between the two views of 10° . The middle photograph is taken straight ahead along the direction of the magnetic field. The current (3000 amperes for $0.4 \mu\text{sec}$) through the source produces a magnetic field which opposes the d.c. field and diminishes the velocity of projection of the plasmoid across the magnetic field.

(facing p. 92)

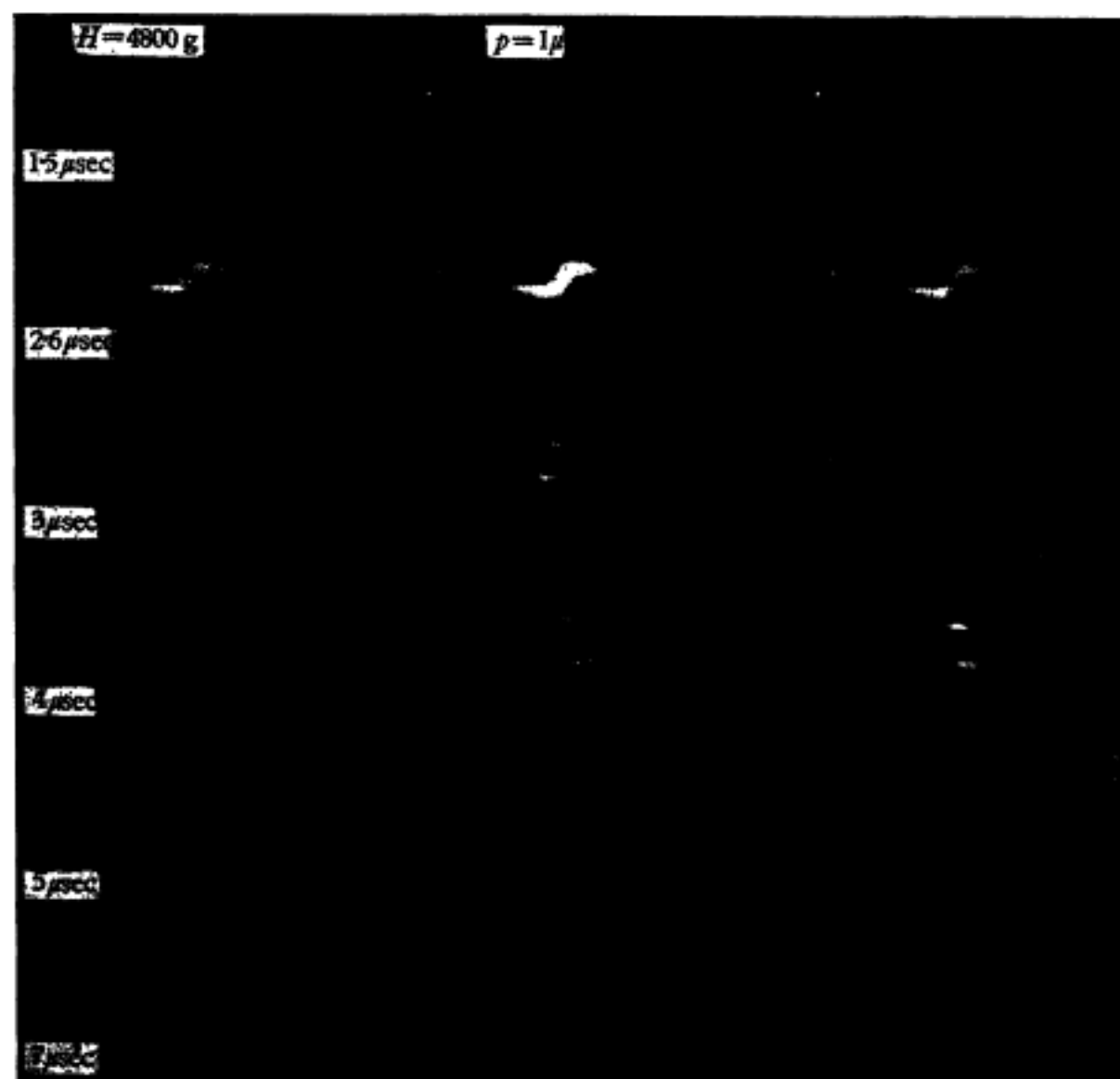

Plate IV. The same as Plate III except that the pressure in the chamber is 1μ .

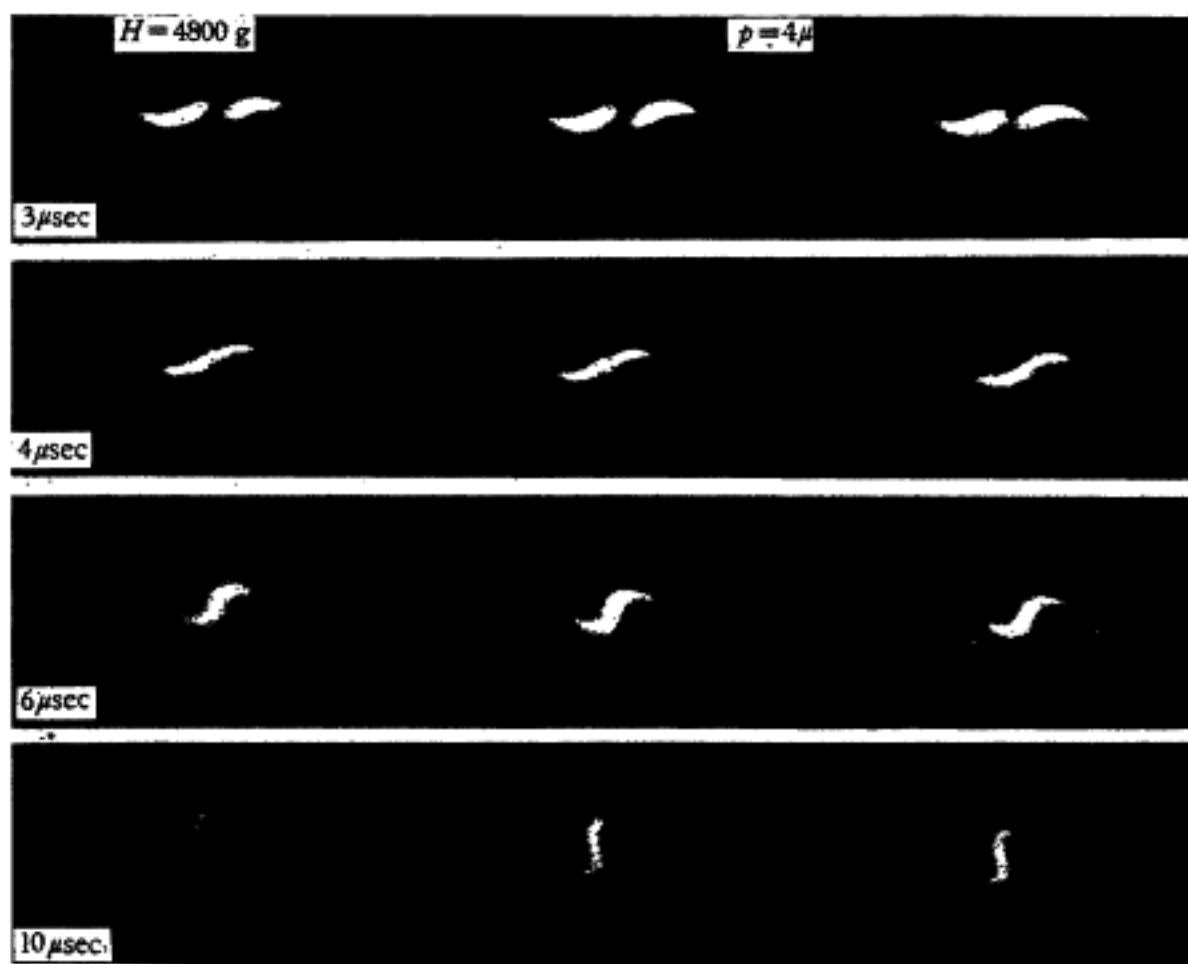
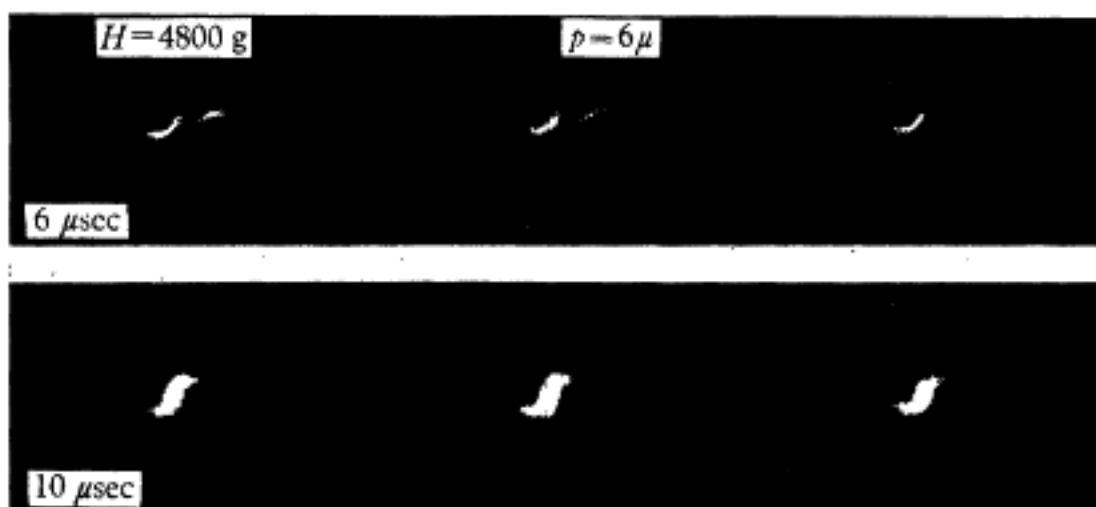

Plate V. The same as Plate III except that the pressure is 4μ .



(a)



(b)

Plate VI (a). The same as Plate III except that the pressure is 6μ .

(b) Signal obtained by probe 1 mm in diameter, 0.5 cm long placed 1 cm from a grounded probe with 50 ohms connecting them. The probe assembly is placed 30 cm distance, axially (away from the camera) down the solenoid from the position of formation of the ring. The sensitivity is 2 v/cm and the sweep speed is $2 \mu\text{sec/cm}$ with time going from right to left. Probe assembly is placed laterally off the axis at the approximate radius of the plasma ring which is formed. The solenoid is 44 cm long and 13 cm in diameter. The pressure in the chamber was 2μ . Much more work is necessary in the study of this type of signal; we tentatively identify these signals with a whirl-ring moving away from the camera.

plasma-magnetic field configuration can also explain the forked tail on each plasmoid seen very clearly in Plate IV. Apparently if the leading loops of the two plasmoids have twisted into such a position that no stagnation

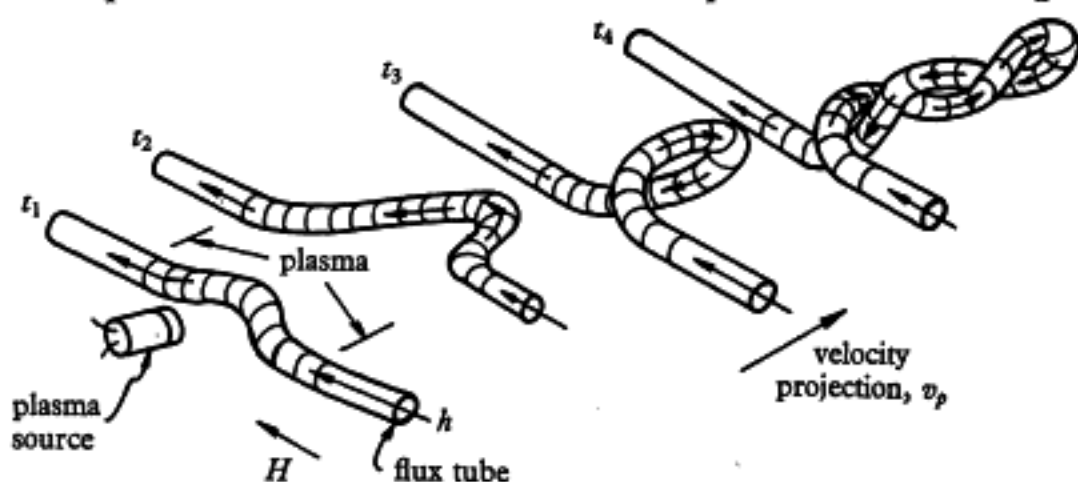

Fig. 2. Suggested configuration of plasma and magnetic field of a single plasmoid projected across a magnetic field when an electromagnetic braking action occurs because of a pressure of about 1μ in the vacuum chamber. The tightly twisted configuration will itself assume a general helical configuration (try twisting two strands of wire, rope, or rubber tightly). This helical configuration is seen especially clearly in Plates V and VI (a).

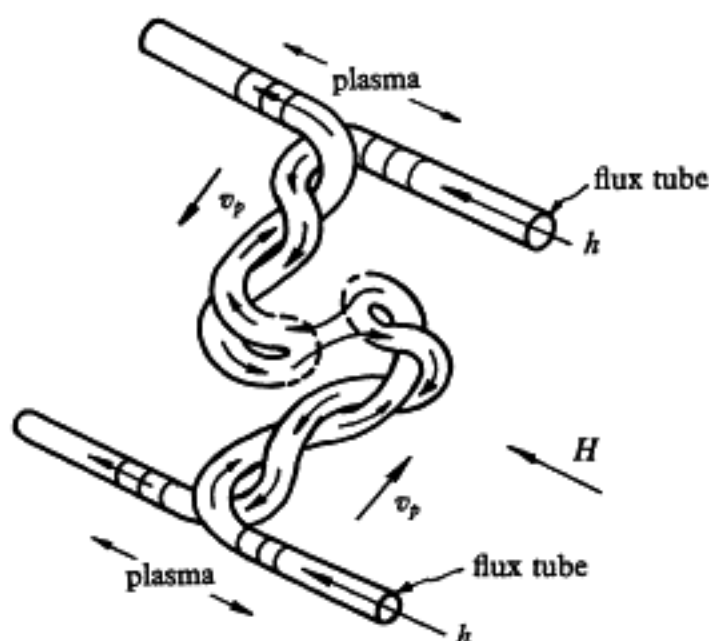

Fig. 3. Suggested configurations of plasma and magnetic fields existing in the formation of a barred spiral. The stagnation point produced when the two leading loops of the plasmoids approach one another permits the lines of force to leap from one plasmoid to another carrying plasma across and tying the two plasmoids together.

point is reached, the plasmoids studiously avoid one another, as shown in Plates V and VI (a).

After the union of the two plasmoids has been accomplished, as in Plates III and IV, the angular momentum will wind them up into a spiral, to a certain extent, until the angular momentum has been brought to zero by the stretching of the field lines. The resultant plasma and magnetic

configuration then seems to be stable. The barred spirals have been followed in time as long as $15 \mu\text{sec}$ and still preserve their shapes with well-defined boundaries. Furthermore the plasma does not seem to migrate in the direction of the original D.C. magnetic field. It is rather astonishing that such a bizarre configuration of plasma and magnetic field should appear to be stable. No theoretician known to the author has *a priori* dreamed of such a configuration, to say nothing of contemplating its stability.

(c) *Production of rings*

We must now try to understand, at least in a qualitative way, how rings or toruses can be produced by plasmoids. Measurements already reported [4] show that with four plasma sources a ring can be produced which

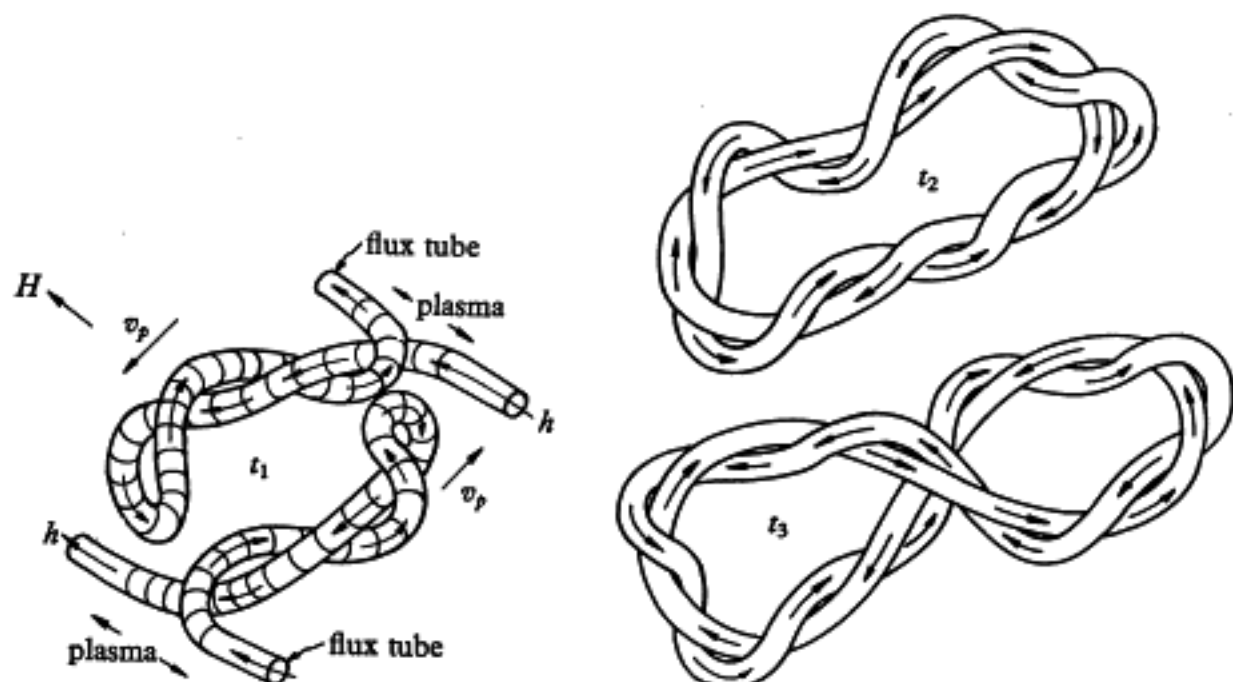

Fig. 4. Suggested sequence of plasma and magnetic-field configurations to explain the flattened ring and 'figure 8' observed in Plate VII. The velocity of projection v_p of the original plasmoids is indicated.

apparently maintains its shape for at least $30 \mu\text{sec}$. Moreover, it is observed that this ring does not move or stretch appreciably in the direction of the D.C. magnetic field during this time interval. The magnetic-field configuration in the ring must, therefore, be such as to confine the plasma in this fairly stable ring.

It has been possible to produce a ring with only two sources (see Plate VII), but the ring produced is flattened. In fact, as time goes on the ring configuration develops a constriction and flips over into a 'figure 8'. Before attempting to understand the rings which are produced with four or more plasma sources, let us first try to understand this flattened ring which is produced by two sources. Fig. 4 suggests a plasma-magnetic field

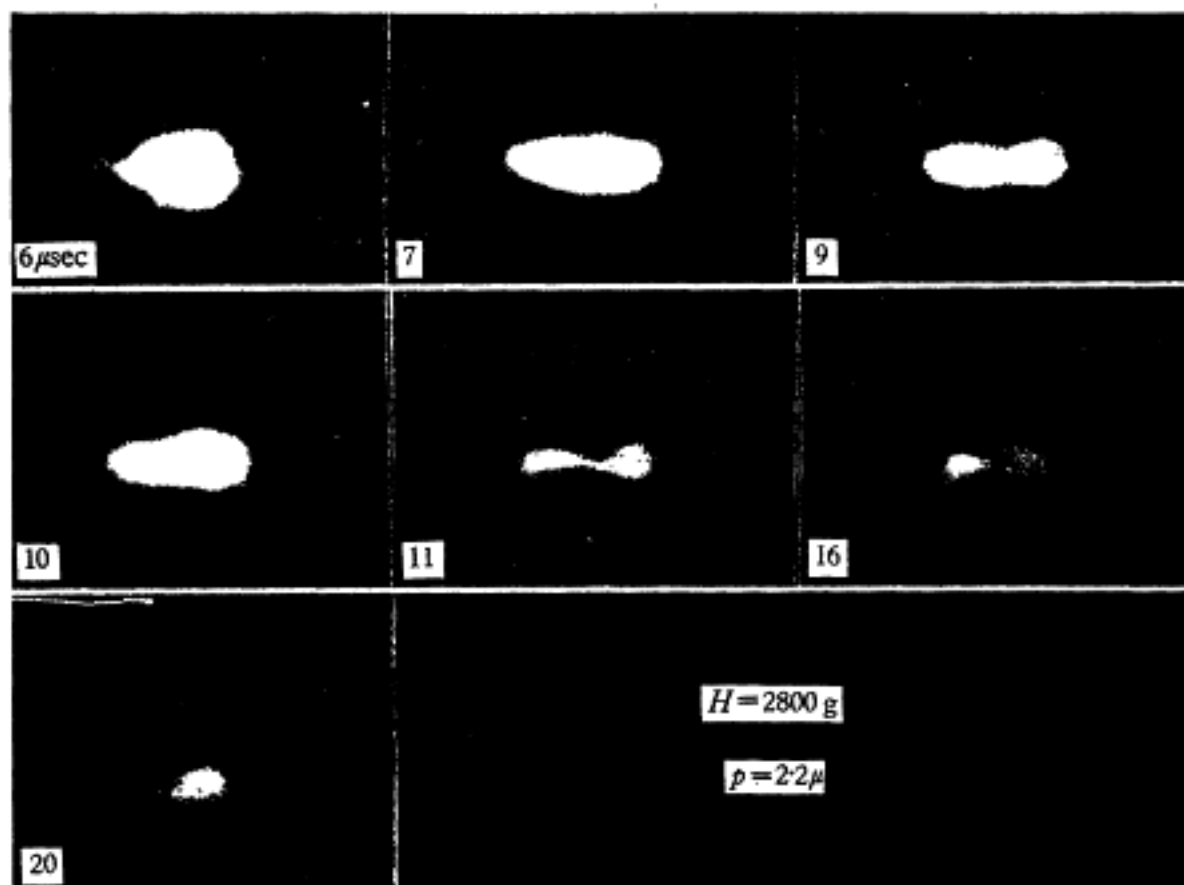

Plate VII. Sequence of photographs of formation of a flattened ring which flips into a 'figure 8'. The ring is formed by firing two sources across a magnetic field (into the paper) of 2800 gauss with a pressure of 2.2 in the chamber. The exposure time is 2 μ sec and the various delay times are indicated in μ sec. The current in the source is in such a direction as to diminish the velocity of propagation in the magnetic field.

(facing p. 94)

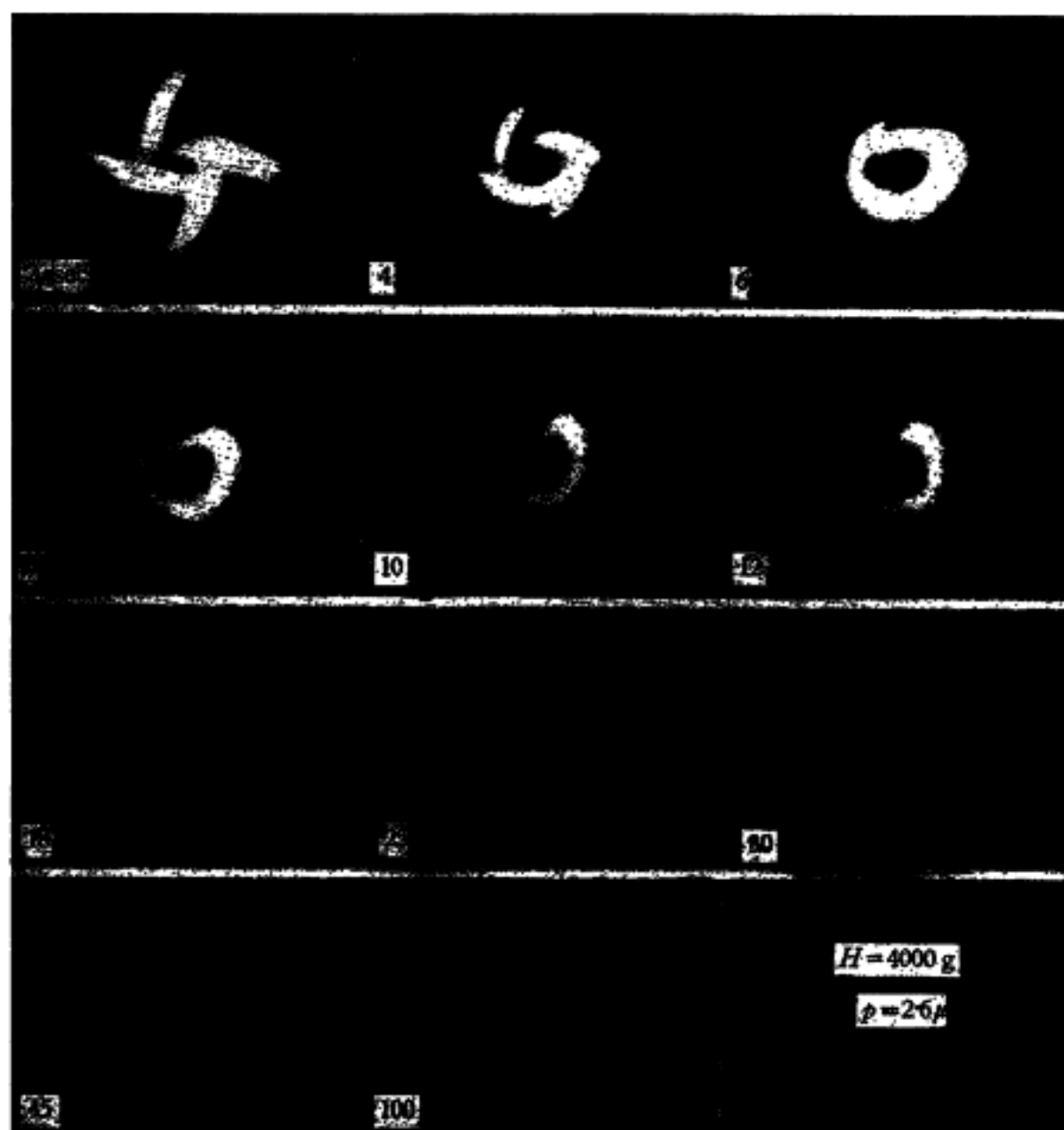

Plate VIII. An example of the formation of a ring by firing four sources across a magnetic field of 4000 gauss (into the paper) at a pressure of 2.6μ . The exposure time is $2 \mu\text{sec}$ and the various delay times are indicated in μsec . The current in the sources is in such a direction that the velocity of projection of the plasma is retarded by the D.C. magnetic field. The $100 \mu\text{sec}$ delay photograph actually shows a faint ring on the original.

configuration to explain the ring shown in Plate VII. It is readily understandable that a flattened ring formed by tightly twisted strands will constrict in the center and form a 'figure 8'. It can be seen from the hypothesis of Fig. 4 that we might actually expect two rings, one formed from each strand, but that they are topologically intertwined.

As has already been reported [4], it is possible to form rings by firing four sources. It is believed that these rings have essentially the same structure as the ring shown in Plate VII and Fig. 4, except that they are initially circular instead of flattened, and they have more angular momentum. Therefore, we may expect the rings formed by four sources to have a tendency to preserve their circular shape instead of flipping into a 'figure 8'. An example of a photographic sequence of the formation of a ring from four sources is given in Plate VIII.

It is possible to produce rings somewhat similar to those of Plate VIII by firing eight sources. Various examples of photographic sequences with eight sources are given in Plates IX, X, XI and XII. Very likely the rings formed by eight sources have higher peripheral velocity and hence more angular momentum than those formed from four sources. This higher peripheral velocity may account for the deformations of the ring which are observed in Plates IX, X and XI at the later times.

It is to be emphasized that these rings which have been produced by having the source current in the direction so as to diminish the velocity of propagation of the original plasmoids across the D.C. magnetic field, remain in focus up to at least $30 \mu\text{sec}$, and in some cases up to $100 \mu\text{sec}$. Therefore we can say that the ring does not move or stretch appreciably in the direction of the magnetic field.

The situation is quite different when the source current is in such a direction as to increase the velocity of propagation across the D.C. magnetic field. Under these circumstances, it has been observed [2,3] that the initial velocity of propagation across the field is greater and the initial diameter of the plasmoid is greater. A sequence of photographs taken under these circumstances with eight sources firing simultaneously is shown in Plate XIII, where the ring which is produced now apparently moves along the D.C. lines of force toward the camera. Probe traces (see Plate VI (b)) taken at a position 30 cm behind the source suggest that there is also plasma (presumably in the form of a ring) traveling along the lines of force in the opposite direction with a velocity $\leq 3 \times 10^6 \text{ cm/sec}$. Here now is a situation which appears to be the simultaneous production of two whirl-rings which move away from one another along the D.C. magnetic-field lines. Plate XIV shows stereo photos taken of the ring which moves toward the camera. The ring

appears to have a helical twist which probably represents the direction of magnetic field and motion of the plasma within the ring. A suggested description of the process of formation of these two rings is given in Fig. 5, where it can be seen that the two rings which are now produced are not topologically entangled but are free to move away from one another. Each of these rings now is similar to the *S*-plasmoid of Fig. 1, except that they exist in a d.c. magnetic field, and h_z and h_θ fields have time to penetrate

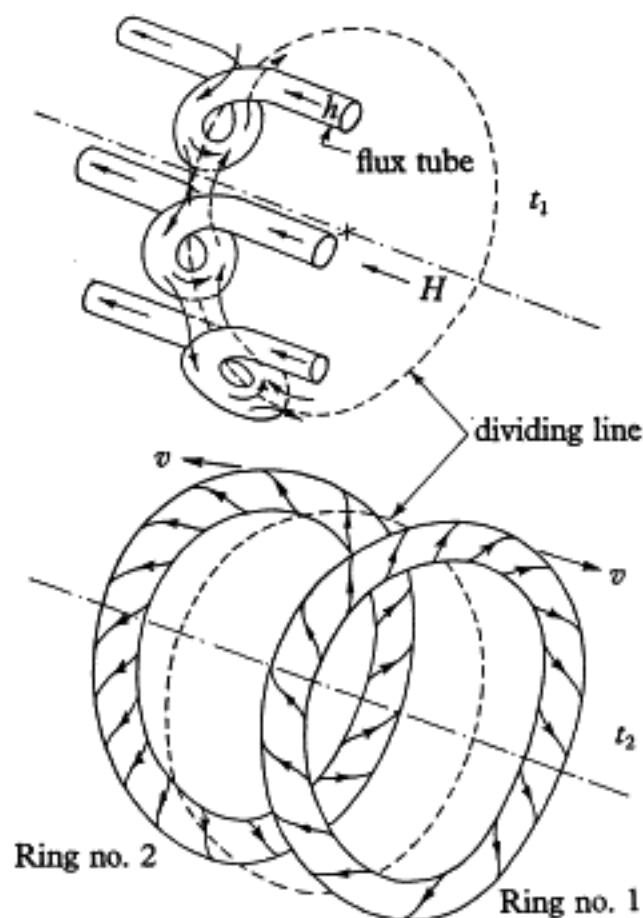

Fig. 5. Suggested description of formation of two whirl-rings which move away from one another, as observed in Plates VI (b) and XIV.

the plasma and add vectorially to produce a helical magnetic-field configuration within the ring. The measurements as yet do not yield quantitative information on whether the rings maintain their diameter as they move along the d.c. magnetic-field lines. It will be necessary to construct a longer solenoid for the magnetic field than the 44-cm solenoid which was used in these experiments in order to examine the radial stability of these rings and to measure their velocity along the field. It will also be necessary to devise a suitable technique for exploring the magnetic fields which are trapped in these rings.

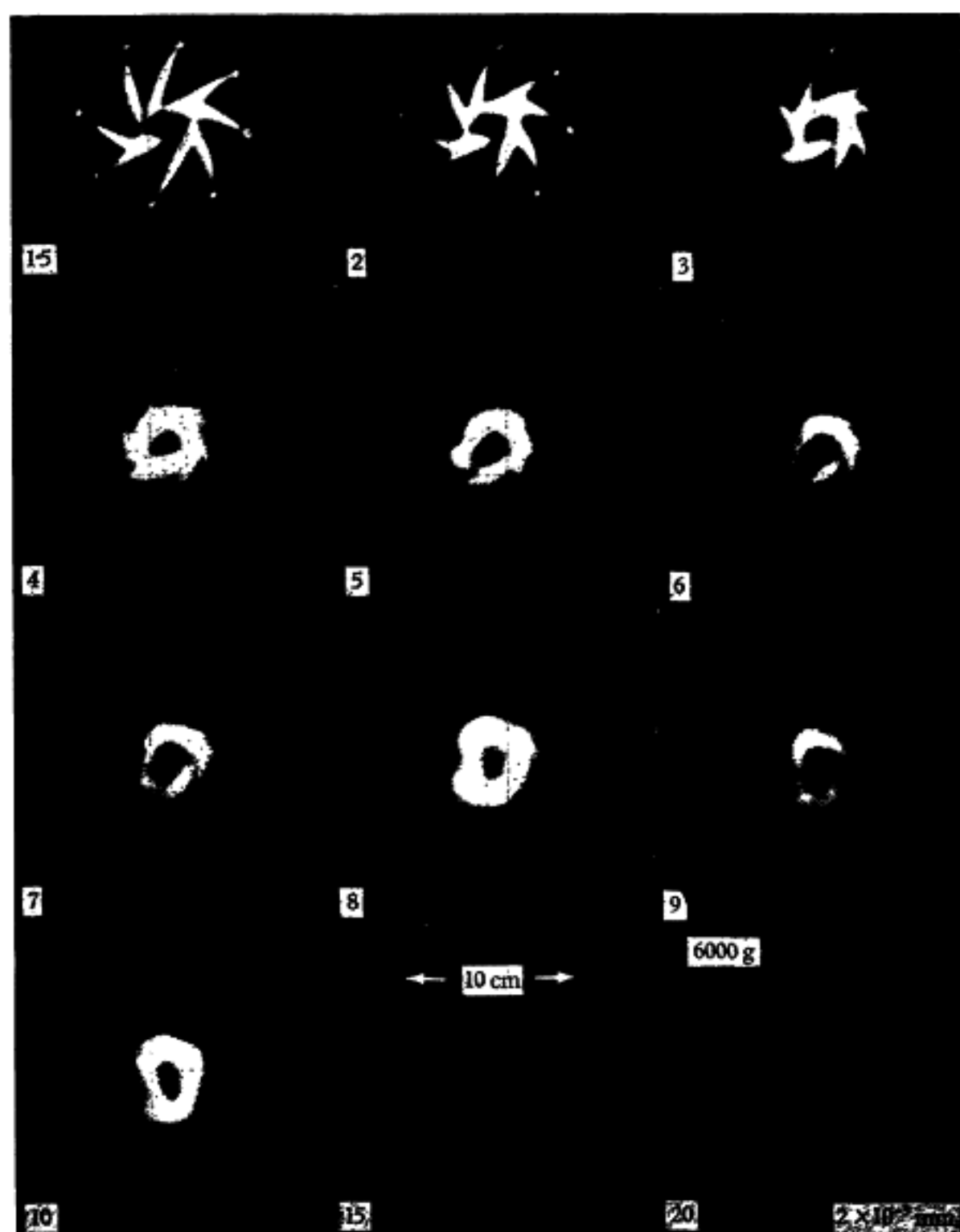

Plate IX. Photographic sequence of the formation of a ring from the plasmoids from eight sources fired across a magnetic field of 6000 gauss, into the paper. The pressure is 2μ . The exposure time is $2 \mu\text{sec}$, and the delay times are indicated in μsec . The current in the sources is in the direction to diminish the velocity of projection of the plasmoids across the d.c. magnetic field. Note that at $15 \mu\text{sec}$ delay, the ring has grown an ear.

(facing p. 96)

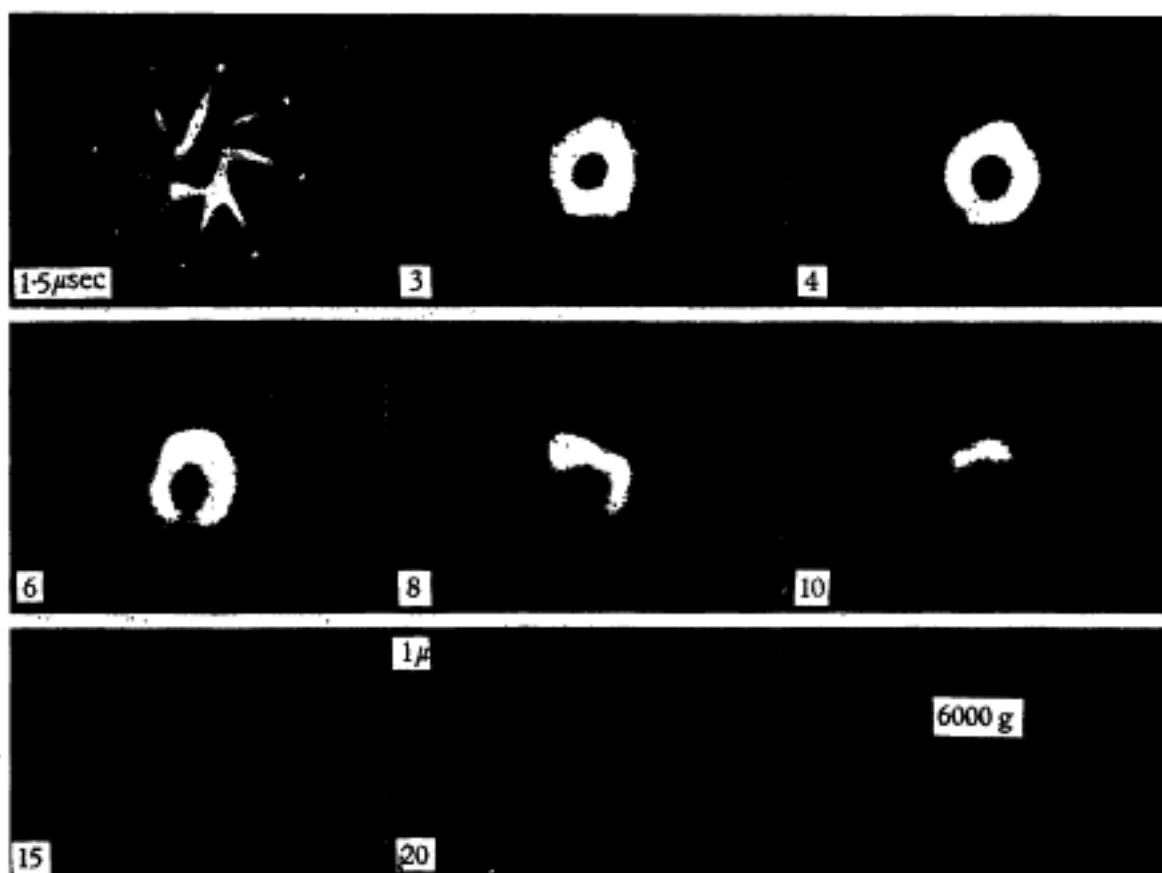

Plate X. Same as Plate IX except that the sources are oriented more symmetrically, and the pressure is 1μ .

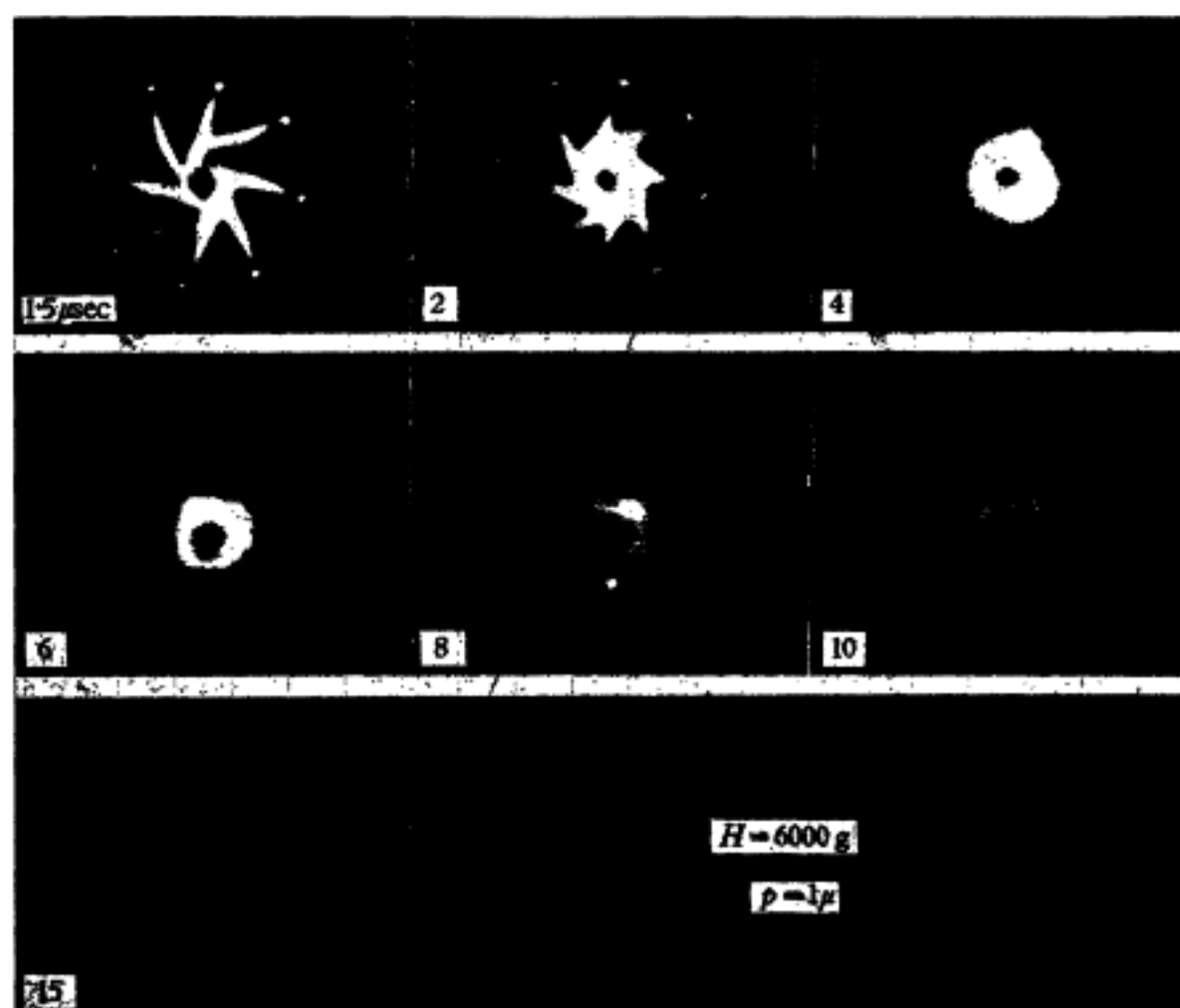
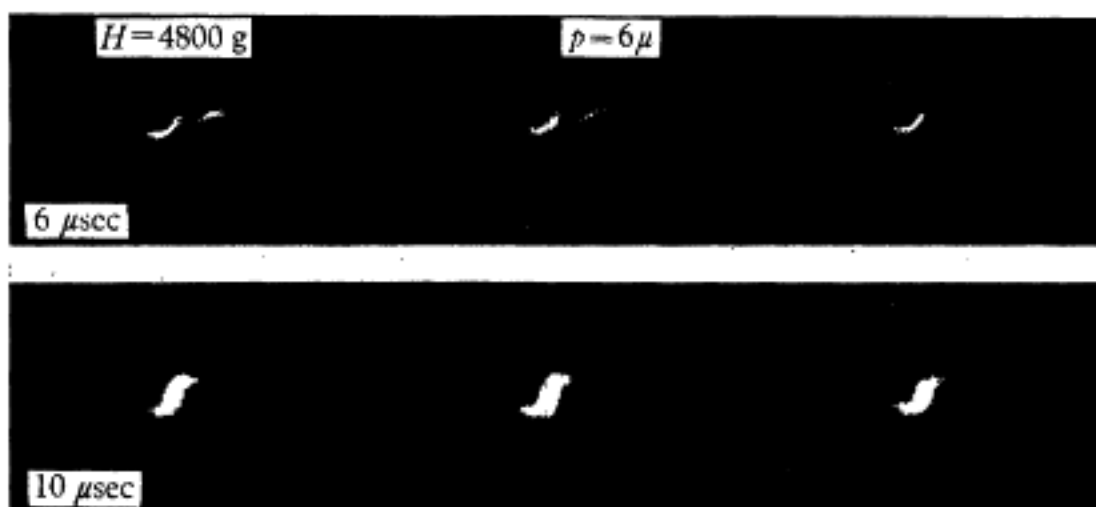

Plate XI. Same as Plate IX except that the sources are aimed so as to produce a smaller diameter ring, and the pressure is 1μ .



(a)



(b)

Plate VI (a). The same as Plate III except that the pressure is 6μ .

(b) Signal obtained by probe 1 mm in diameter, 0.5 cm long placed 1 cm from a grounded probe with 50 ohms connecting them. The probe assembly is placed 30 cm distance, axially (away from the camera) down the solenoid from the position of formation of the ring. The sensitivity is 2 v/cm and the sweep speed is $2 \mu\text{sec/cm}$ with time going from right to left. Probe assembly is placed laterally off the axis at the approximate radius of the plasma ring which is formed. The solenoid is 44 cm long and 13 cm in diameter. The pressure in the chamber was 2μ . Much more work is necessary in the study of this type of signal; we tentatively identify these signals with a whirl-ring moving away from the camera.

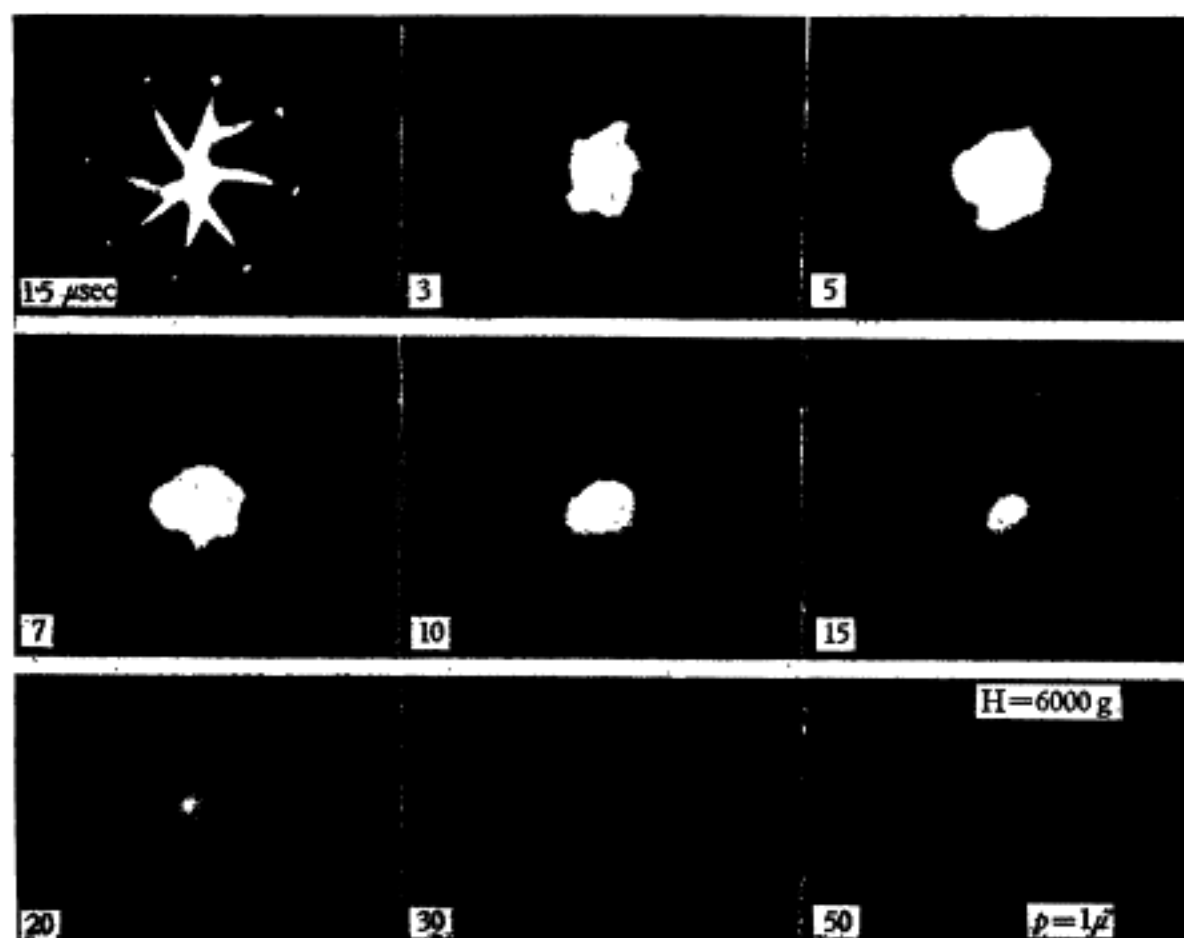

Plate XII. Same as Plate XI except that the sources are aimed to produce an even smaller ring. The original photograph shows an illuminated blob of plasma lasting out to 50 μ sec.

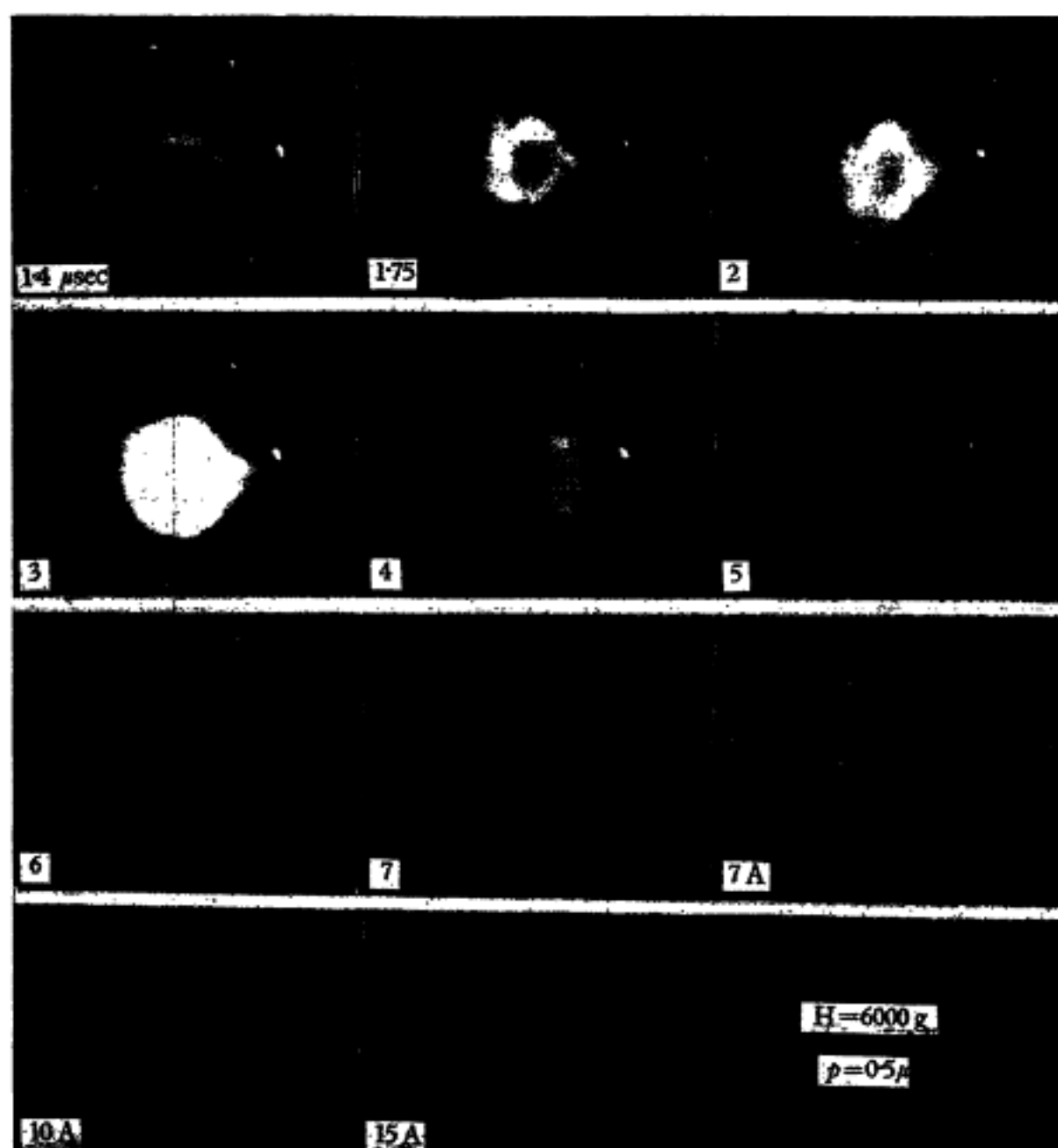

Plate XIII. Sequence of photographs taken in a manner similar to those of Pl. IX except that the source current is in the direction which *aids* the velocity of propagation of the plasmoid across the magnetic field, and the pressure is 0.5μ . The whirl-ring which is formed gets progressively out of focus as it apparently moves toward the camera, and at $7 \mu\text{sec}$ delay, it is badly blurred. The delay times '7A, 10A, and 15A' correspond to moving the camera back 15 cm which, at least for 7A sharpens up the picture. It is believed that for delays 10A and 15A, and perhaps for 7A, the ring has travelled until it has encountered the lucite window of the vacuum system which is 20 cm from the position where the ring is formed.

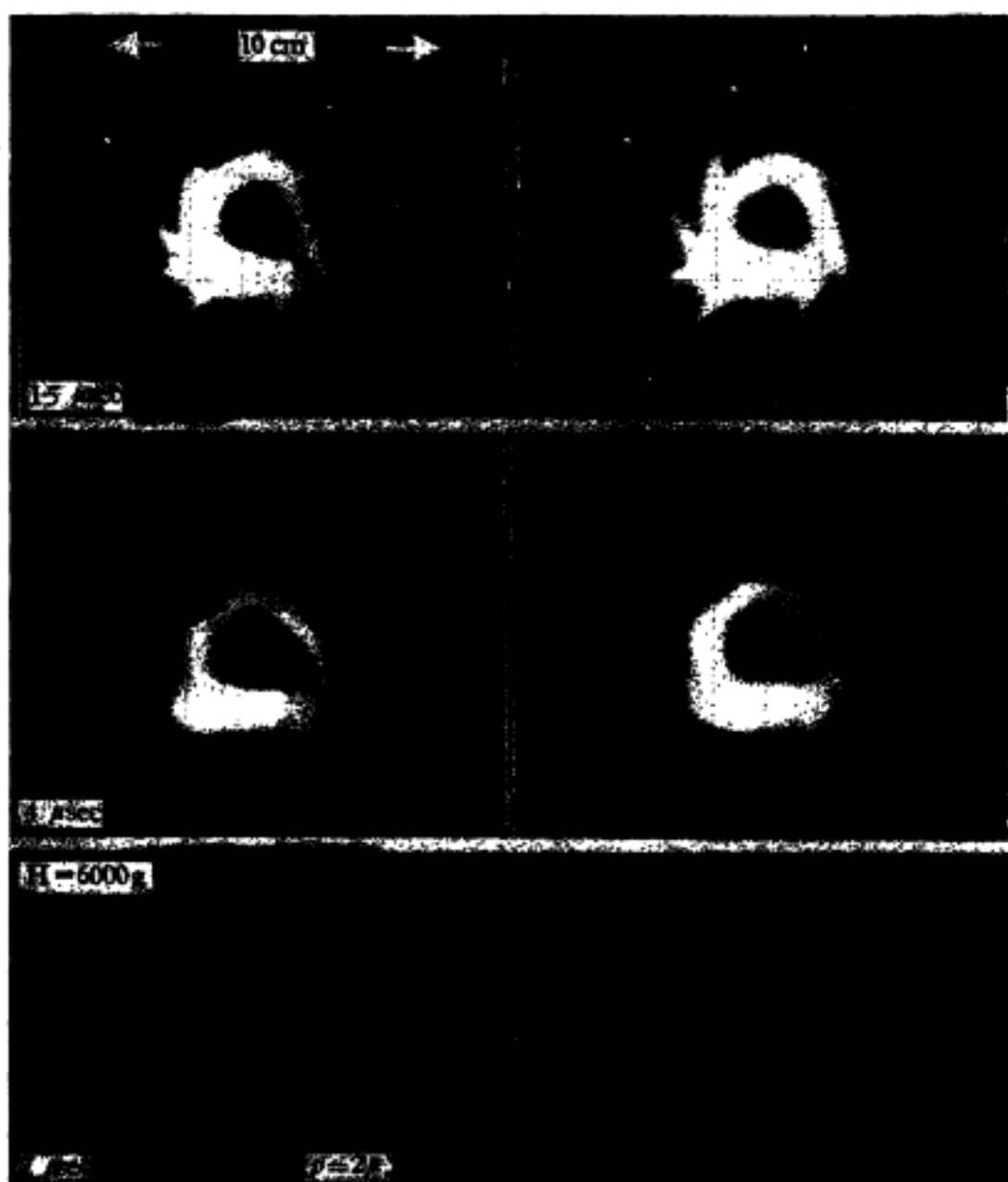

Plate XIV. A sequence of stereo photos (20° between the two) of the rings produced, as in Pl. XIII, with the pressure equal to 2μ . For the $7 \mu\text{sec}$ delay the camera was refocused for an object distance closer by about 15 cm, to compensate for the fact that the ring apparently moves toward the camera. The $4 \mu\text{sec}$ delay photo, especially, suggests that the ring is constructed of material which has a helical twist.

3. CONCLUSION

By firing simultaneously two or more plasmoids across a magnetic field it has been possible to produce co-operative phenomena which not only simulate the production of spiral galaxies and astronomical barred spirals but which permit us to study these processes in the laboratory. Hypotheses to explain the experimental effects have been advanced in outline. Accurate quantitative work and detailed theoretical analysis should now begin.

4. ACKNOWLEDGMENTS

The author wishes to acknowledge the fine experimental work of Orrin A. Twite who assisted in the work and who took many of the photographs, and to V. G. McIntosh who constructed the plasma sources. Gratitude is due to W. R. Baker, O. A. Anderson, Jack Reidel, and N. J. Norris for the loan of the Kerr-cell equipment. The author wishes to thank S. A. Colgate and C. M. Van Atta for their support, encouragement, and advice in this work.

REFERENCES

- [1] Bostick, W. H. *Experimental study of ionized matter projected across a magnetic field*, Univ. of California, Radiation Laboratory, Livermore Site, Rep. no. UCRL-4695, 1956.
- [2] Bostick, W. H. *Phys. Rev.* **104**, 292, 1956.
- [3] Harris, E., Theus, R. and Bostick, W. H. *Phys. Rev.* **105**, 46, 1957.
- [4] Bostick, W. H. and Twite, O. A. *Nature, Lond.* **179**, 214, 1957.

Discussion

Blackett: I must say that I appreciate very much the new kind of experiments that Dr Bostick has done. I think it is an extraordinary exciting new field. Perhaps the theoretical solution of those phenomena lies somewhere in Dr Schlüter's equations.

Ferraro: This is an interesting and important paper. I was particularly interested in two of the phenomena described by Dr Bostick. The first concerns the fact that a plasmoid was able to move freely in a magnetic field perpendicular to its direction of motion. I believe the explanation that Dr Bostick suggested is in fact likely to be the true one, that is, that the polarization electric field generated by the motion of the plasmoid in the magnetic field balances the electromagnetic deflecting force. The two tracks left behind by the plasmoid are in fact the polarization surface charges which are trapped by the magnetic field. This is the solution Chapman and I first gave in our papers on magnetic storms and it is gratifying to see these experiments bearing on the theory.

The second comment I wish to make refers to Dr Bostick's remark that the magnetic impulse registered by a magnetic coupling loop as a plasmoid passed over it may have some bearing on the theory of sudden commencements of magnetic storms. It seems to me that a 'solar plasmoid' is unlikely to imitate even qualitatively the variation of the horizontal force observed during a sudden

commencement. This remains fairly constant for an hour or so after the sudden commencement, unlike the variations of the magnetic field which are associated with a passage of the plasmoid over the loop.

Bostick: I must say that there is in no way an exact analogy between conditions in cosmical physics and in the measurements we made. But the plasma enters the magnetic field of the earth and—this may be pure speculation—it may enter the region of the earth in the form of a ring (plasmoid), similar to what is observed in the laboratory. In that way it might give a fast-rising but sustained impulse to the magnetic field by forming a type of ring-current. Also, our laboratory plasmoids are the result of the emission of plasma in one short impulse, whereas the solar emission of plasma may be a relatively sustained emission.

I should like to say that if we can shoot plasmoids across a magnetic field, in the laboratory, it may be possible for a plasma to be shot across the solar magnetic field into interplanetary space. It is probable that when such a plasmoid leaves the sun it will take a part of the sun's magnetic field with itself; I do not know what the shape of the plasma configuration will be.

Alfvén: These are extremely fascinating results. They stress again the importance of experimental approach to astrophysical problems. But before applying the results to cosmical physics it would be very important to find a relevant criterium for the existence of plasmoids in astrophysics. Could you by some similarity transformation give such a criterium?

Bostick: Of course. The speeds we have are comparable with the astronomical speeds; one can say that we have the same order of magnitude in the speed-situation. Concerning the densities we are way out by a factor of 10^{15} . All these things have to be worked out more in detail.

von Engel: How did you measure the magnetic moment of a free plasmoid and what numerical results have been obtained?

Bostick: A signal is picked up from the plasmoid by a magnetic coupling loop. The field measured was of the order of 100 gauss.

von Engel: What was the nature of the light emitted and did it show lines from the metal and the gas?

Bostick: We have made some measurements lately and practically all the light is contained in the lines of titanium I and titanium II and in the Balmer series. Presumably this light is recombination light. If there are other lines they are relatively very dim.

Swann: Concerning the photographs which showed a kind of elastic scattering of one ring by another, the orbits and impact parameters seem sufficiently definite to enable one to calculate the forces concerned in the collisions if one knows the masses of gas in the rings and the velocities. Has such a calculation been made and if so, what is the implication as regards the nature of the force?

Bostick: No, we have not made such calculations. But the amount of momentum which is carried by the plasma coming out of the source can be measured by mechanical macroscopic means quite easily.

Ferraro: Have you measured the densities?

Bostick: No, we have not, but we have inferred a value of $10^{11}/\text{cm}^3$ from probe measurements 100 cm from the source. The measurement is difficult to carry out since it is transient and the ion density is high.