

Magnetic Universe Theory

A Top-Down Review of Phases of Magnetic Theory Development, with accompanying historiography and comparison with Unified/Aether Field Theories including EPEMC

Sf. R. Careaga, BSEE, MSTOM¹

Ancient Kentucke Historical Association, Lexington, KY, USA

August, 2018

ABSTRACT

Increasing Human Energy is reconsidered through a historical and conceptual review of the most important currents of electromagnetism and atomic theory. New alternatives are considered, and a Unified Aether is shown to be Plasma-Electromagnetism. Mainstream cosmology's historical development is shown to be lacking in rationalism in key non-Electric arenas. Magnetics are further revised and the possibility of an all Magnetic Universe is considered, and then re-unified with the PEMF. Energy production methods are proposed which rely on the PEMF.

Key words: Maxwell's Laws, Quantum, Electrodynamics, Magnetohydrodynamics, Relativity, Big Bang, Black Holes, Plasma Physics, Birkeland, Alfvén Reconnection, New Electromagnetism, Electroweak, Electrogravity, Electrokinetics, Einstein, Tesla, Leedskalnin, Steinmetz, Hawkins, Thornhill, Crothers, Dowdye, Distinti, LaPoint, TT Brown, Jefimenko

¹ This work contains materials evaluated under Fair Use Copyright Law. Some of the material is held under copyright via other owners, which are cited and referenced appropriately. The owner makes no claim to these works as being EPEMC™ itself. All copyrighted images belong to respective owners. All evaluations herein are for educational/comparative use only. This work is presented free, and the author makes no money from the production of this EPEMC™ property. All Rights Reserved to prospective copyright owners, respectively.

Introduction

Magnetism is an anciently known effect. Both Egypt and China, and possibly Mesoamerica, knew of this phenomena early. However, China succeeded in creating the compass (via “south-pointing chariot”).²

More recently, since the 1600’s³ (William Gilbert⁴) and especially the 1800’s,⁵ experiments with planetary terrellas have resulted in ever increasing fascination with magnetism. It isn’t surprising, given magnetism’s ability to bedazzle children with hidden, seemingly mystical effects. It is both tangible, and intangible (though made visible with typical iron filing displays, see Figure 1). There are now hundreds of strange magnetic devices and experiments:

- Switchable magnetics
- Programmable shaped magnets
- “Monopoles”
- High density permanent magnets
- Electromagnet “maglev” trains and carriages.
- Superconductor toys
- Magnetic goo or putty
- Magnetic “snakes”
- Etc...

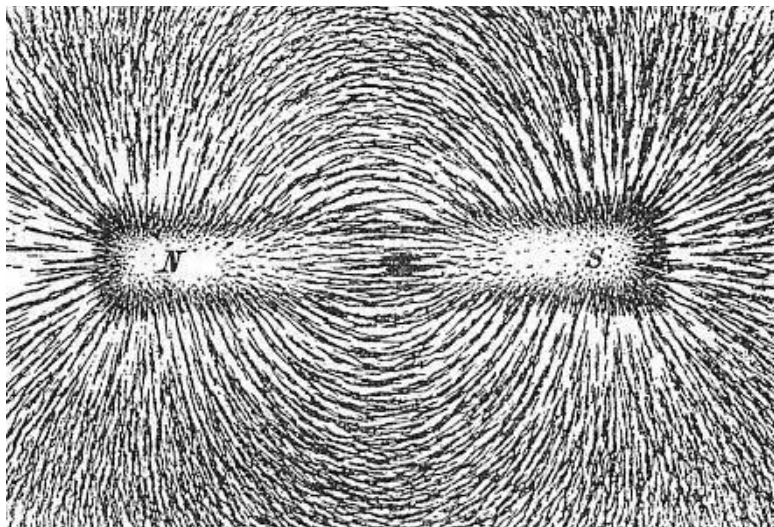

Figure 1 - Classic Magnet+Iron Filings experiment/demonstration

This fascination has only increased in Science as well. From the time that Franklin discovered lightning was electricity,⁶ and that Faraday and Maxwell Unified electricity and magnetism into electromagnetism,⁷ the rapid acceleration of human technological progress (especially after Tesla’s AC and AC motor/generators⁸) has not ceased. However, though electricity remained somewhat stagnated, except for signals, circuits, and plasma studies, magnetism has enjoyed constant fanfare and scientific rigor.

² https://en.wikipedia.org/wiki/South-pointing_chariot

³

https://web.archive.org/web/20140714194058/http://philoscience.unibe.ch/documents/MaterialHS11/PSWissRev/Zinsel194_1.pdf

⁴ [https://en.wikipedia.org/wiki/William_Gilbert_\(astronomer\)](https://en.wikipedia.org/wiki/William_Gilbert_(astronomer))

⁵ <http://www.mhs.ox.ac.uk/sphaera/index.htm?issue7/articl6>

⁶ https://en.wikipedia.org/wiki/Kite_experiment

⁷ <https://metode.org/issues/article-revistas/electromagnetic-unification.html>

⁸ <https://www.history.com/topics/inventions/nikola-tesla>

In the 1950's-1970's two revolutionary fields set the Electric Field⁹ to 0 except in one (y) direction. These fields deal primarily with the differential equations of B fields derived from Maxwell/Heaviside: Quantum Electrodynamics¹⁰ and Magnetohydrodynamics. Both Feynman and Alfvén, colleagues belonging to each field, respectively, later lamented this decision.¹¹ Feynman appears to have been correct, at least in regards to certain boundary conditions.¹²

However, another name contemporaneous to Langmuir, Birkeland, Bohr, etc..., Edward Leedskalnin believed quite literally that the electron was not real and was nothing more than constantly alternating magnetic moments (a sort of double-spring mechanism).¹³ More recently, David LaPointe has made progress in demonstrating the “double bell” shape that is familiar in plasma shapes in space and lab.¹⁴

NASA/ESA and worldwide scientists have taken to calling Birkeland Currents “magnetic flux ropes” (or tubes, or jets), and describing all the current as associated with AGN,¹⁵ Black Holes,¹⁶ Hawking Radiation,¹⁷ Neutron Stars, etc..., and pointing to solid evidence from magnetic measurements of “reconnection” and “frozen-in” fields^{18 19} (a term Alfvén disavowed²⁰ as it is incorrect²¹), while only recently acknowledging there are electric currents involved²² (even parallel to, but 90 degrees out of phase with B-field “flux”).²³

So the question is, who is right? To add more confusion to the matter, it has become clear that the photon model as an EMF wave and particle are untenable at best. For if the EMF behaves as a particle, it may be treated as an atom and bonded, and if as a wave, it surely cannot bond with anything.²⁴ Ken Wheeler has suggested that rather the photon is an induction moment, and the speed of light, *c*, is a rate of induction through the potential magnetic field.²⁵ He has written a long [non peer-reviewed, self-published] textbook on magnetism that expands on this concept.²⁶

So, who is right? Is the Universe primarily electric, or magnetic?

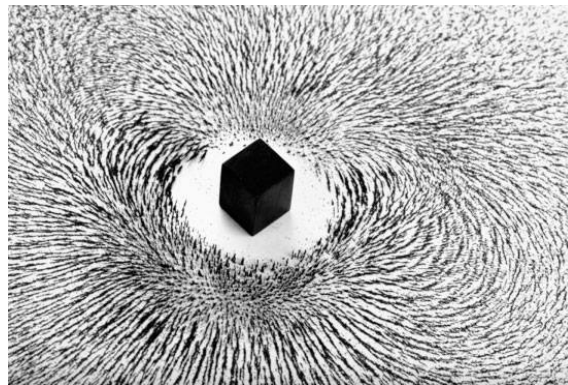

Figure 2 - Magnetic Fields, do they have real flux?

⁹ <http://iopscience.iop.org/article/10.1088/0031-9120/51/5/055005/meta>

¹⁰ The Feynman Lectures on Physics: The New Millennium Edition ..., Volume 2, Feynman
http://www.feynmanlectures.caltech.edu/II_07.html

¹¹ <http://coincider.com/wp-content/uploads/2014/10/edgescience-09.pdf>

¹² <https://arxiv.org/ftp/arxiv/papers/1609/1609.05567.pdf>

¹³ <http://www.leedskalnin.com/Leedskalnins-Writings-MAGNETIC-CURRENT.html>

¹⁴ <https://www.youtube.com/watch?v=9EPlyiW-xGI>

¹⁵ <https://arxiv.org/pdf/1712.08414.pdf>

¹⁶ <https://phys.org/news/2018-02-dynamics-black-hole-rotational-energy.html>

¹⁷ <https://arxiv.org/pdf/0705.2984.pdf>

¹⁸ http://sun.stanford.edu/~sasha/PHYS780/PLASMA_PHYSICS/phys780_2014_l21.pdf

¹⁹ <https://farside.ph.utexas.edu/teaching/plasma/lectures1/node64.html>

²⁰ https://en.wikipedia.org/wiki/Alfv%C3%A9n%27s_theorem

²¹ <https://agupubs.onlinelibrary.wiley.com/doi/abs/10.1029/JA081i022p04019>

²² <https://www-spf.gsfc.nasa.gov/Education/wcurrent.html>

²³ <https://arxiv.org/abs/1006.2662>

²⁴ <https://phys.org/news/2013-09-scientists-never-before-seen.html>

²⁵ <https://www.youtube.com/watch?v=whoylwf-i0A>

²⁶ <https://ia802502.us.archive.org/31/items/magnetism1small/magnetism1small.pdf>

The quintessential issue is obviously related to an ancient Daoist one: if all is Dao (unified field), how is there a yin (negative principle, positive charge/proton) and a yang (positive principle, negative charge/electron)²⁷ at the same time?

In Daoism this is solved as a matter of consciousness:

0 1 1 2 | 3 5 8 13... "10,000 myriad things"
^nothing/Wuji, Shunyata or Void
 ^Dao, the ineffable field (dan)
 ^Taiji, emergence of singular principle
 ^Heaven-Earth dipole force (electromagnetism)²⁸
 ^Pre/Post Heaven asymptote, preventing direct observation of 0/1 field²⁹
 ^combination of Taiji and Heaven/Earth yields conscious-awareness
 ^arising of seasons and Change/Flux
 ^Bagua, arising of Change principles, roots of Laws
 ^arising of physiognomy and expansive experience

Because of our consciousness we are unable to conceive, except symbolically, of a singular field, as proven by our need to see an empty ("0") principle (first invented by Sumerians, mathematically³⁰). However, though we must start with a 0+1 to get our first unified field, the "Taiji", and then need to divide (deduce/derive mathematically) to have "Liangyi" (reality), according to transcendental, philosophy, and worldwide religious agreement (even among polytheists), the principle is singular.³¹

In physics, this issue returns to the "Wave-Particle Duality" double-slit experiment conundrum.³² But how can something be both a wave and a particle? How can magnetism be so obvious, but electricity so mysterious? How can magnetic moments be induced by *either* a current *or* a changing electric field?³³

Again, Leedskalin insisted that the entirety of them is all one unified field: magnetism (and that gravity was the alignment of tiny magnetic dipole moments in atoms).³⁴ Electricity is reduced to a "magnetic current"³⁵.

Yet in the field of Quantum mechanics, plasma high energy physics, and of course electrical engineering related topics, Electricity is of prime discussion and cannot, in any means be reduced to simple magnetism.³⁶ Can it be that the same field looks one way when *interfaced* with in one way, and look differently in another direction? Robert Distinti argues yes.³⁷ That within permanent magnets which defy Maxwell and Faraday and Ken Wheeler, are tiny edge currents³⁸ (he ascribes to Etheric "pretons"³⁹). But the electromagnetic

²⁷ Benjamin Franklin arbitrarily attributed charge symbolism before the discovery of the atom or subatomic particles. As the case happens to be, electrons are actually positive principle (moving), and protons/nuclei are dense, and heavy. Therefore when Coronal Holes spray the Earth with protons, the typical response in a healthy individual is depressed energy, while negative charge (such as negative ions at waterfalls and beaches) elevates mood and provides energy. Both can have opposite effects in certain situations and certain "reversely polarized" individuals. Everything is relative.

²⁸ Wuji, Hundun, and Dao as well as the "separating of Heaven and Earth" all have analogs in Sumeria and Egypt in both gods and manifestation as thunderbolts related to Zeus battling Tython (a comet-tail), and vajra/tridents seen in the sky.

²⁹ The asymptotic barrier here represented with an |, is invisible. However, it may be related to the issue of Einstein's "no constant uniform observer" in Special Relativity.

³⁰ <https://www.scientificamerican.com/article/what-is-the-origin-of-zero/>

³¹ ... as it is related to the ancestral worship of the God-King Saturn and his Heavenly abode, the encircling rings, Ogygia

³² https://en.wikipedia.org/wiki/Double-slit_experiment

³³ Ampere's Law, see: Appendix B.IV.10

³⁴ <http://www.leedskalin.com/LeedskalinsPMH-CommonCoreConcept.html>

³⁵ Ibid.

³⁶ <https://physics.stackexchange.com/questions/309271/a-question-on-the-unification-of-electricity-and-magnetism>

³⁷ <https://www.youtube.com/watch?v=50aWFL0JIVk>

³⁸ <https://www.youtube.com/watch?v=QReGWNPF5fSs>

³⁹ His term, <https://www.youtube.com/watch?v=iRaB90jv0XQ&list=PL2fbwSsQ2zIUbWGVl8CXpaVSzY5kUXVrW>

(read: electroweak, electrogravitic, simplified EMF) force **needs no medium for propagation of energy** as a wave.⁴⁰ It *is* the medium. Moreover, in PEM and EPEMC in general, the author must agree with the Daoist concept of Taiji, and of unification and simplification (to adhere to Occam's Razor): the field is unified, and cannot be ascribed wholly to magnetism as we know it.⁴¹

The mere fact of rapidly emerging "oddities" - such as superconductivity, which is most assuredly ill defined - points to a need to re-orientate and realign our view of electromagnetism into a simpler "Aether", which is not so etheric as it is both pragmatic and yet as predicted, elusive and ineffable.⁴²

This EPEMC paper will therefore focus on magnetism but keep reminding the reader that one cannot actually isolate them from one another, no more than one can have a true monopole, or "flux" or flux disconnections to reconnect. Rather *something* is increasing concentration or dilution, and *aligning* to an underlying "aether" or "matrix" of principles and data (typically understood through the **tool or model** known as mathematics).⁴³

The author has no proposed replacement terminology for the "double-spring", counter-rotating, 90 degree out of phase, real+imaginary, wave-particle dual function known currently as electromagnetism. However, it will, in time, be known to be both reality and super-reality, the atomic and etheric, and responsible through its non-linear, charge-separated, differentiation to be the formation of all principles and forces, including the life-force. In this paper it will be simply referred to as either EMF or PEM, depending on context.

NOTE - the included Appendices are repetitions of those found in the earlier "Plasma-Electromagnetic Sky".⁴⁴

2nd NOTE - the title is a test of Leedskalnin's assertion, taken up by many. The author intends to show it is mere semantics.

⁴⁰ https://science.nasa.gov/ems/02_anatomy

⁴¹ <https://arxiv.org/ftp/arxiv/papers/1701/1701.01523.pdf>

⁴² In fact, the very issue of Dao, Qi (energy/life-force), and Yi (changes) is that although the Dao cannot be named or measured, and Qi cannot be definitely identified and quantified, though it is very real, somehow constant Change is the only real Constant. This paradox of reality greatly reflects the problems Quantum Mechanics is having at reducing from the final 4 or 5 solutions (which Chinese call Chaos, Luck, Fate, and Destiny/Karma) into a single **excluding** solution. They are all 4 reducing to equal validity. It appears unlikely to be reduced mathematically anytime soon.

⁴³ The author wishes to make it clear that mathematics is not science or scientific, in and of itself.

⁴⁴ [4]

A (Brief) History of Magnetism and Magnetic Theory

It is likely that magnetism was first truly known about by the Atlantean cultures, however we have no proof of them or such knowledge *as being from that period*, only the proof of the Giza Power Plant itself.⁴⁵ What is known is that the Egyptians recognized the subtle power of magnetite (lodestone⁴⁶)⁴⁷ (as did many cultures⁴⁸⁴⁹) in jewelry, magic⁵⁰ and in medicine. Quite interestingly, Mesopotamians also had advanced knowledge of electrochemical reactions, and produced their “Baghdad batteries” in earthen vases (see Figure 3.)⁵¹ There may have also been many smaller or larger ones that we haven’t found.

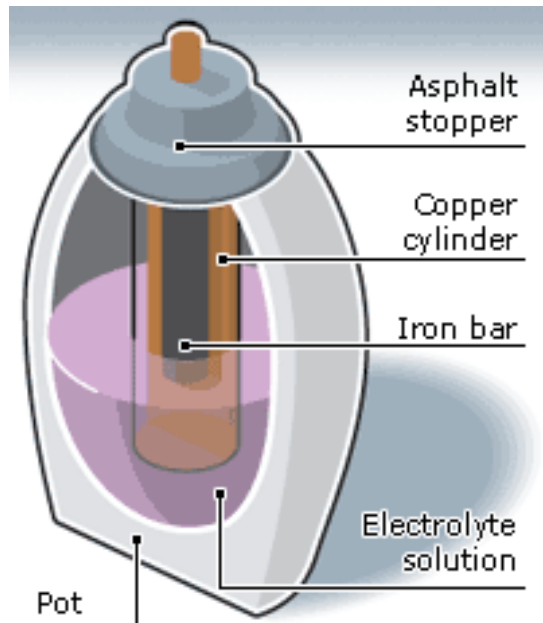

Figure 3 - inner workings of 2000 yo Baghdad Battery; credit: BBC

Even more interestingly, during the dynastic periods, hieroglyphics were produced which depicted “crookes tubes” in action,⁵² and recognized the wave-like behavior of electromagnetism (see Figure 4). It is clear that the following order of events can be ascertained:

Discovery of magnetite > Refinement of magnets > discovery of electricity > making of batteries > Giza⁵³ > electric-plasma illumination (as proved by the absence of soot, and the hieroglyphics).⁵⁴

⁴⁵ “The Giza Power Plant,” Chris Dunn, 1998

⁴⁶ <https://en.wikipedia.org/wiki/Lodestone>

⁴⁷ “Ancient Egyptians referred to lodestone as the bone of Haroeri, grandson of the goddess of the earth.” <http://www.creativekidsathome.com/science/magnetp2.html>

⁴⁸ <https://nationalmaglab.org/education/magnet-academy/history-of-electricity-magnetism/museum/lodestone>

⁴⁹ Carlson, J. B. (1975). “Lodestone Compass: Chinese or Olmec Primacy?: Multidisciplinary analysis of an Olmec hematite artifact from San Lorenzo, Veracruz, Mexico”. *Science*. 189 (4205): 753–760

⁵⁰ “The earliest Chinese literary reference to magnetism occurs in the 4th-century BC *Book of the Devil Valley Master* (*Guiguzi*). In the chronicle *Lüshi Chunqiu*, from the 2nd century BC, it is explicitly stated that “the lodestone makes iron come or it attracts it.” The earliest mention of a needle’s attraction appears in a work composed between 20 and 100 AD, the *Lunheng* (*Balanced Inquiries*): “A lodestone attracts a needle.” In the 2nd century BC, Chinese geomancers were experimenting with the magnetic properties of lodestone to make a “south-pointing spoon” for divination. When it is placed on a smooth bronze plate, the spoon would invariably rotate to a north-south axis.” *ibid*.

⁵¹ https://en.wikipedia.org/wiki/Baghdad_Battery

⁵² Dunn, *ibid*.

⁵³ <https://sites.google.com/site/electricuniversegateway/recent-news/pyramidstruepurposeuniverseinsideyou>

⁵⁴ This may be a controversial subject, but it is, after all, crucial to understanding our own progress and predicaments.



Figure 4 - Egyptian light bulbs (Crookes Tubes), which clearly depicted the transforming process and sources of knowledge.

However, certain sets of cataclysms, and at least one power plant failure at the Great Pyramid,⁵⁵ appear to have ended this enlightened (but limited in use⁵⁶) period of mankind. What followed was truly Dark Ages. Mankind resorted back to the original way of acquiring energy: exothermic chemical reactions (burning fuel).

But, Mankind never quite lost the fascination with magnetism. It has been used for hundreds of years as a form of medicine, in both China and Rome.⁵⁷ As mentioned before, *De Magnete*⁵⁸ was published in the 1600s by William Gilbert along with several other works on lodestones and magnetism.⁵⁹ Magnetism was, however, a fascination of the eccentric, the noble classes,⁶⁰ and real advanced science did not take place with magnetism until the late 1700s or early 1800s.⁶¹ However, it was, in many ways to be maligned or conflated with the subject of another *more seriously researched by many*⁶² subject: the Aether.⁶³

The reader pray will forgive the small detour, therefore, into the subject of the Aether, before continuing with electromagnetism.

⁵⁵ <http://www.gizapyramid.com/stephen%20mehler%20research%20article.htm>

⁵⁶ We have found no cables, and there is no proof of extended use of electricity for more than lighting and hydraulic pumping.

⁵⁷ <http://www.magnetipupin.com/magnets/>

⁵⁸ <http://www.new-science-theory.com/william-gilbert-de-magnete.pdf>

⁵⁹ <http://www.lancaster.ac.uk/fass/projects/gilbert/docs/onloadstonemagne00gilbuoft.pdf>

⁶⁰ This is an ancient fascination. Cleopatra even had lodestone jewelry.

<https://www.naturalmagnetism.com/history-of-magnetic-therapy.html>

⁶¹ <https://nationalmaglab.org/education/magnet-academy/history-of-electricity-magnetism/timeline>

⁶² ... and still is (essentially) https://news.nationalgeographic.com/news/2006/09/060908-dark-matter_2.html

⁶³ <http://www.cellularuniverse.org/AA3AetherHistory.htm>

I - The Search for the Unified Aether-Field

The concept of a luminous, fluid Aether/Ether hereafter called an Aether Field (AF), is not new. Ancient India was the first scientific culture to espouse a documented belief in this concept,⁶⁴ dating back to at least the 2nd millennium BCE.⁶⁵ However, the debate in Greece although it centered around the four materia medium: fire, earth, water, and wind,⁶⁶ and including a fifth element the spirit or animum (or quintessence),⁶⁷ it was thought by some Greek philosophers that an underlying strata must exist.⁶⁸

The thinking behind the presence of an AF is rather simple: things move, but prior to their movement they demonstrate potential predictability.⁶⁹ This would mean some underlying guiding principle is at work.^{70 71} Take for instance in the Laws of Life, the Axiom of Becoming.⁷² At some point in time and object or organism reaches maximum potential and it then either shrinks or even dies, and quickly, allowing the processes of entropy to take over.

The underlying mechanism or principle which guides this *reversion*⁷³ is not explicitly labeled in western physical science. The author would postulate that this is precisely because underlying western science has always been the assumption of an aether or etheric force. It is so ubiquitous that when Einstein formulated his ether: space-time, the masses of physicists did not stop to doubt it (some did⁷⁴), but instead immediately adopted it, without asking, "Can you combine space and time?"⁷⁵ But we digress.

Unification

The real issue is not so much whether one man's ether theory, or another's is correct. All of them are, and none of them are, for precisely the reasons state in the Daodejing,

⁶⁴ <http://www.ayurvedacollege.com/articles/drhalpern/ether>

⁶⁵ <https://www.scienceandnonduality.com/science-and-the-existence-of-ether/>

⁶⁶ https://en.wikipedia.org/wiki/Classical_element

⁶⁷ "The word αἰθήρ (*aithēr*) in Homeric Greek means "pure, fresh air" or "clear sky". In Greek mythology, it was thought to be the pure essence that the gods breathed, filling the space where they lived, analogous to the *air* breathed by mortals.¹ It is also personified as a deity, Aether, the son of Erebus and Nyx in traditional Greek mythology. Aether is related to αἶθω "to incinerate", and intransitive "to burn, to shine" (related is the name *Aithiopes* (Ethiopians; see Aethiopia), meaning "people with a burnt (black) visage").

"In Plato's *Timaeus* (58d) speaking about air, Plato mentions that "there is the most translucent kind which is called by the name of aether (αἰθήρ)" but otherwise he adopted the classical system of four elements."

[https://en.wikipedia.org/wiki/Aether_\(classical_element\)](https://en.wikipedia.org/wiki/Aether_(classical_element))

⁶⁸ "The fifth Orphic hymn to Aether describes the substance as "the high-reigning, ever indestructible power of Zeus," "the best element," and "the life-spark of all creatures." Though attributed to the mythological poet Orpheus who lived before the time of Homer, the likely composition of the hymns in the 6th-4th centuries BCE make them contemporary with natural philosophers, such as Empedocles, who theorized the material forces of nature as identical with the gods and superior to the anthropomorphic divinities of Homeric religion." [https://en.wikipedia.org/wiki/Aether_\(mythology\)](https://en.wikipedia.org/wiki/Aether_(mythology))

⁶⁹ https://www.academia.edu/35438996/Wisdom_and_foresight_in_Chinese_thought_sensing_the_immediate_future_2018

⁷⁰ Though the Chinese Five Elements (Wu Xing) do not contain Aether as do the Indian and Greek counterparts, Chinese have 3 etheric concepts from 3 different schools: Dao, Qi, and Shi 勢

<http://www.heterogeneities.net/publications/LawLin2017TidescapesNotesOnAShiInflectedSocialScience.pdf>

It may interest the reader to know, however, that the Wu Xing and Bagua are all conceptualized as the same *one* flow that is Dao.

⁷¹ "The Propensity of Things," Jullien, 1999

⁷² Appendix B.V.3

⁷³ In Chinese this is called "jue" 厥 (reverting). It is also called the *Mysterious Pivot*, 靈樞

⁷⁴ https://en.wikipedia.org/wiki/Criticism_of_the_theory_of_relativity#A_Hundred_Authors_Against_Einstein

⁷⁵ <http://www.thunderbolts.info/forum/phpBB3/viewtopic.php?f=8&t=535>

“The Tao that can be spoken is not the eternal Tao⁷⁶
 The name that can be named is not the eternal name
 The nameless is the origin of Heaven and Earth
 The named is the mother of myriad things...
These two emerge together but differ in name
The unity is said to be the mystery
 Mystery of mysteries, the door to all wonders.”⁷⁷

As mentioned in the Introduction (above), the problem is the asymptotic filter in reality. Coming from the dualistic perspective, it is natural to presume that first there is this, and then that (“if, then” logic, aka deduction). However, this will generate the need for an etheric force, energy, field, or structure which then acts as the *transportation medium* of: energy, waves, messages, information, thought, vibration, etc... It is partly an issue of time as well as the space around it.⁷⁸ However, the Michelson-Morley experiment⁷⁹ (and the Double-Slit⁸⁰) has clearly demonstrated this to be an illusion of the observer’s fabrication.

The fact is that all of these ideas are transferred directly in a single, unified aether field (UAF): the electromagnetic wave.⁸¹

The electromagnetic wave is versatile, coming in: currents, point charges, particles, atomic and molecular arrangements, ions and isotopes, light, and various plasma mode interactions.⁸² It also has several strange communicative properties, such as superconductivity⁸³ and crystallization (lattice) formation,⁸⁴ which all seem to indicate a pre-programmed underlying harmony.⁸⁵

There also famously exists various forms of quantum *weirdness* such as “spooky action at a distance,”⁸⁶ which is due to electromagnetic signalling *instantly* from quark to quark. Let us not also fail to mention that the yang of electromagnetism is not without its yin in the form of anti-matter and anti-EMF, which operates the anti-verse.⁸⁷ However the rules appear to be the same.

The entirety of this UAF is none other than the Plasma-Electromagnetic Cosmology (PEMC). PEMC is not a false AT or UAF, it is the **only** ether which has been found (only Dao). All others are *speculative models* which are, for lack of a better way to put it: forms of electromagnetic behavior which have not been understood

⁷⁶ Dao 道 - the way; origin: perhaps observations of the Milky Way or movement of the stars, but more likely electrical behaviors in the sky and weather. Contains the sun radical.

<https://icbi.weebly.com/etymology-of-the-ideogram-lsqquodaorsquo.html>

⁷⁷ Daodejing Verse 1, Laozi, transl.D. Lin <https://www.taoism.net/ttc/chapters/chap01.htm>

⁷⁸ This would provide solid foundation for Einstein’s theory of space-time if it had any rational basis rather than relying upon itself for proof of itself. Take, for example, the model of curved space-time. To explain gravity, the Newtonian concept of gravity weighing down masses is evoked to bend the aforementioned curved space-time, and implies a certain amount of *friction* as well. This type of circular reasoning is, unfortunately, overlooked because it is so visually appealing (because Newton’s gravity is very natural).

⁷⁹ https://simple.wikipedia.org/wiki/Michelson%E2%80%93Morley_experiment

⁸⁰ The Double-Slit conundrum of wave vs. particle helps clearly demonstrate the issue of the aforementioned filter. Heisenberg and Schrödinger both elaborated on the issues of variability due to observation. That things look different to different perspectives, and at different times, and depending on expectations may have shocked Science, but is not so surprising from a practical living standpoint. Most people find these concepts intuitively true. Hence supernatural experiences.

⁸¹ https://en.wikipedia.org/wiki/Electromagnetic_radiation

⁸² Plasma modes: dark, glow, arc, high-energy, condensate, quark/gluon, etc...

⁸³ The temperature at which resistivity in a substance *magically* becomes **exactly 0**.

<https://en.wikipedia.org/wiki/Superconductivity>

That is to say “we don’t know what is happening, so we will break electro-thermodynamic law instead.”

⁸⁴ <https://study.com/academy/lesson/ionic-compounds-formation-lattice-energy-and-properties.html>

⁸⁵ <https://sciencing.com/5-emergent-properties-water-8622128.html>

⁸⁶ <https://phys.org/news/2015-11-nist-team-spooky-action-distance.html>

⁸⁷ <https://en.wikipedia.org/wiki/Antimatter>

mathematically, and may have been proposed or discovered but not yet comprehended. As for extra states of matter, they are actually just various modes of plasma in an electromagnetic field under shifting pressure and charge densities.

The fact that electricity and magnetism, and the interaction of the four (real) phases of matter (and all the phony lab created kind⁸⁸) - plasma, gases, liquids, and solids - are all that we have observed in lab or nature, from subatomic (and seen with electron microscopy⁸⁹) to the macroscopic (supergalactic), is a *probable indicator* that that is all there is, in terms of the materia strata (ie, Nature).⁹⁰

Electro+magnetism (EM)

As in the eastern concept of yin and yang, which are truly one principle (taiji)⁹¹, electricity and magnetism are **one**, and cannot be separated.⁹² It has been discovered that magnetic fields can be induced via either moving charges or electric currents (these being composed of incredibly small quantum sized electric fields which accelerate the electron and form the basis of the current). However, under no circumstances can magnetic fields be broken down into true monopoles,⁹³ or disconnected.⁹⁴ They are, by definition, closed loops connecting the north and south poles of a dipolar body or system.⁹⁵

Electrical fields, on the other hand, are curvilinear vectors which connect opposing charges, charge fields, gradient densities, or high voltage/tension potentials to low or 0 (relative to Earth) voltages. They can be interrupted by the presence of another body, aka a differently charged body.⁹⁶

There are, ostensibly, an infinite variety of electrical field line connections everywhere.⁹⁷ Theoretically, the entire framework of electric fields and magnetic fields constitutes the entire UAF's volume and the apparent fullness of reality (as both solids and fluids and space⁹⁸ are completely full of particles of one sort or another in one phase of matter or another.) Any inability of an individual to imagine this fullness, or the means of electrical and luminous motion and accelerations (negative or positive), is merely an issue of computational size, and scale, which would be overwhelming if all 3 vector directions were accounted for.

Therefore it is acceptable for Feynman and Quantum electrodynamics to set the Y and Z vectors to 0,⁹⁹ but not reasonable to state that this is the sum total of behavior in all three directions. Our success with signals, power, circuits (which are linear), and electronics notwithstanding, they are limited to a binary understanding in a unilinear formation. Our most cylindrical approach in these applications thus far has been the coaxial cable¹⁰⁰ and quarter wave planar physics,¹⁰¹ both of which rely on two dimensional algebra and

⁸⁸ <https://listverse.com/2015/08/03/10-unusual-states-of-matter/>

⁸⁹ It is a fact that nothing below the size of an electron can be seen, much less than a quark or proposed (ridiculously small) strings. All such theories are pseudoscientific at best, and pure bunk at most. They are *not* scientific theories or hypotheses as they are unfalsifiable.

⁹⁰ Naturally, the discussion of the supernatural, and of the *true* nature of consciousness is beyond the scope of this paper. As is God.

⁹¹ Taiji 太极; a concept derived from directly observed natural phenomena and possibly an onward view of the Birkeland Current (Peratt); [2]

⁹² <https://physics.stackexchange.com/questions/309271/a-question-on-the-unification-of-electricity-and-magnetism>

⁹³ https://en.wikipedia.org/wiki/Magnetic_monopole

⁹⁴ <http://www.thunderbolts.info/forum/phpBB3/viewtopic.php?f=3&t=16599&sid=ed73ff128606a33b0058fbc5f271b02e&start=15>

⁹⁵ <https://en.wikipedia.org/wiki/Magnetism>

⁹⁶ https://en.wikipedia.org/wiki/Electromagnetic_interference

⁹⁷ Every charged particle has a relationship with every other charged particle! So in a system of 4 particles you have 4! Or 24 connections, but in a 5 particle system you have 5! Or 120 connections. Practically speaking, even in a finite Universe the connections are pragmatically infinite, although infinity is not a number.

⁹⁸ Space, like reality, exhibits the famous paradox, "True emptiness is not empty"; $0+1=1$

⁹⁹ http://www.feynmanlectures.caltech.edu/II_07.html

¹⁰⁰ See Appendix A; <https://arxiv.org/pdf/1712.08414.pdf>

¹⁰¹ <https://www.cst.com/academia/examples/quarter-wave-transformer>

calculus.¹⁰²

But though it is acceptable, it is not permanent, nor complete. It is perhaps now more than ever, that the definitions of electricity and magnetism be completed. Robert Distinti has taken new steps, which are covered in the next section. Donald Scott has also released excellent calculations of the coaxial Birkeland Current.¹⁰³ But our scientists at NASA/ESA have also begun this process, even finding electric currents parallel (but 90 degrees out of phase with) to magnetic fields.¹⁰⁴ It is problematic that magnetic fields are being misunderstood to have flux (real flow),¹⁰⁵ and be disconnected, however, inroads are being made to help astronomers and the public understand the difference between these two distinct types of fields.¹⁰⁶ See figures 5-7.

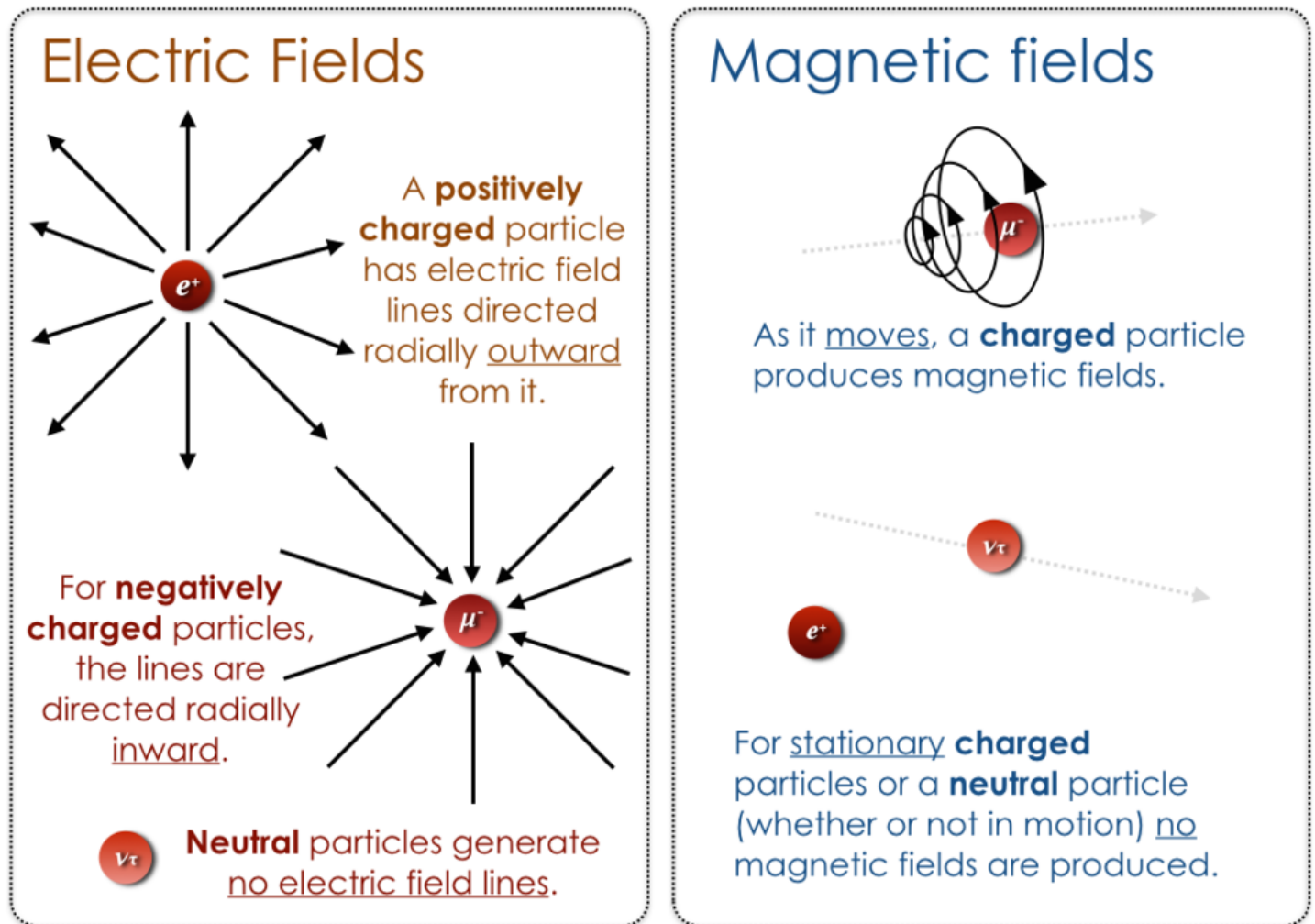

Figure 5 - Comparison of E and B Field production¹⁰⁷; credit: T McCarthy¹⁰⁸

¹⁰² Geometric or linear algebra; vector calculus. X and rho (or phi) angles.

¹⁰³ <http://www.ptep-online.com/2015/PP-41-13.PDF>

¹⁰⁴ <http://iopscience.iop.org/article/10.1088/2041-8205/741/1/L15/pdf>

¹⁰⁵

<https://www.khanacademy.org/science/physics/magnetic-forces-and-magnetic-fields/magnetic-flux-faradays-law/a/what-is-magnetic-flux>

¹⁰⁶ Efforts such as Thornhill and Scott, holoscience.com also Khan Academy:

<https://www.khanacademy.org/science/physics/magnetic-forces-and-magnetic-fields/magnetic-flux-faradays-law/v/flux-and-magnetic-flux>

¹⁰⁷ <https://www.youtube.com/watch?v=uJPO297vsQA>

¹⁰⁸ <http://www.thomasgmccarthy.com/an-introduction-to-collider-physics-v/>

	point charge	infinite line of charge	infinite plane of charge
electric field \vec{E} units: N/C	 $E \propto \frac{1}{r^2}$	 $E \propto \frac{1}{r}$	 $E \propto 1$
magnetic field \vec{B} units: Tesla (T)	(no magnetic monopoles)	 $B \propto \frac{1}{r}$	 $B \propto 1$

Figure 6 - Comparison of Field shapes; credit: wyzant.com¹⁰⁹

	magnitude of force	direction of force	diagram
electric force \vec{F}_E	$F_E = qE$ depends on: - charge of particle, q - strength of field, E	along E-field lines	
magnetic force \vec{F}_B	$F_B = qvB \sin\theta$ depends on: - charge of particle, q - velocity of particle, v - strength of field, B - angle between velocity and field, θ	determined by the right hand rule	

Figure 7 - Field equations and the directions of force; credit: wyzant.com

¹⁰⁹ <https://www.wyzant.com/resources/lessons/science/physics/magnetism>

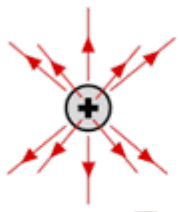
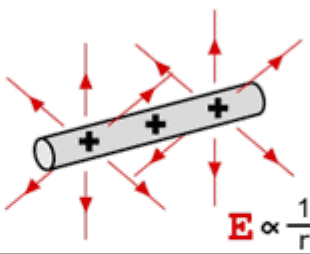
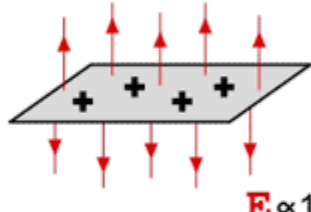
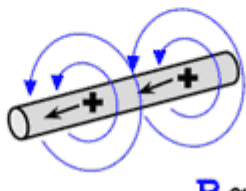
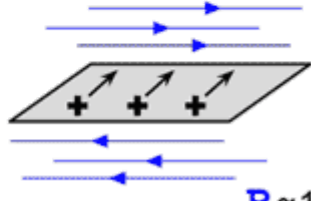
Table 1 - Side by side comparison of analogs of Electricity and Magnetism

Term	Electric	Magnetic
Basic laws	$\mathbf{F} = \frac{Q_1 Q_2}{4\pi\epsilon_r^2} \mathbf{a}_r$	$d\mathbf{B} = \frac{\mu_0 I d\mathbf{l} \times \mathbf{a}_R}{4\pi R^2}$
	$\oint \mathbf{D} \cdot d\mathbf{S} = Q_{\text{enc}}$	$\oint \mathbf{H} \cdot d\mathbf{l} = I_{\text{enc}}$
Force law	$\mathbf{F} = Q\mathbf{E}$	$\mathbf{F} = Q\mathbf{u} \times \mathbf{B}$
Source element	dQ	$Q\mathbf{u} = I d\mathbf{l}$
Field intensity	$E = \frac{V}{\ell} \text{ (V/m)}$	$H = \frac{I}{\ell} \text{ (A/m)}$
Flux density	$\mathbf{D} = \frac{\Psi}{S} \text{ (C/m}^2\text{)}$	$\mathbf{B} = \frac{\Psi}{S} \text{ (Wb/m}^2\text{)}$
Relationship between fields	$\mathbf{D} = \epsilon\mathbf{E}$	$\mathbf{B} = \mu\mathbf{H}$
Potentials	$\mathbf{E} = -\nabla V$	$\mathbf{H} = -\nabla V_m \text{ (J = 0)}$
	$V = \int \frac{\rho_L dl}{4\pi\epsilon r}$	$\mathbf{A} = \int \frac{\mu I d\mathbf{l}}{4\pi R}$
Flux	$\Psi = \int \mathbf{D} \cdot d\mathbf{S}$	$\Psi = \int \mathbf{B} \cdot d\mathbf{S}$
	$\Psi = Q = CV$	$\Psi = LI$
	$I = C \frac{dV}{dt}$	$V = L \frac{dI}{dt}$
Energy density	$w_E = \frac{1}{2} \mathbf{D} \cdot \mathbf{E}$	$w_m = \frac{1}{2} \mathbf{B} \cdot \mathbf{H}$
Poisson's equation	$\nabla^2 V = -\frac{\rho_v}{\epsilon}$	$\nabla^2 \mathbf{A} = -\mu\mathbf{J}$

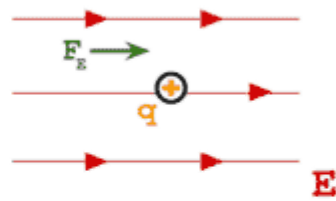
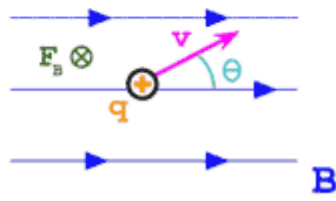
Table 2 - Maxwell's Laws (See Appendix B.IV); credit: wolfram.com

Gauss's Law for Electricity	$\nabla_{\{x,y,z\}} \cdot \mathcal{E}(x, y, z, t) = \rho(x, y, z, t)$
Gauss's Law for Magnetism	$\nabla_{\{x,y,z\}} \cdot \mathcal{B}(x, y, z, t) = 0$
Faraday's Law	$\nabla_{\{x,y,z\}} \times \mathcal{E}(x, y, z, t) = -\frac{\partial \mathcal{B}(x,y,z,t)}{\partial t}$
Ampere's Law	$\nabla_{\{x,y,z\}} \times \mathcal{B}(x, y, z, t) = \frac{\partial \mathcal{E}(x,y,z,t)}{\partial t} + j(x, y, z, t)$

Faraday, Gauss, Ampere and James Clerk Maxwell were four unique thinkers who changed the world. Their contributions were not necessarily as satisfying and obvious at first as those of Edison or Marconi, but they were absolutely invaluable. At the time, the Newtonian world of isolated objects, reaching out to each other through the void of space was an unquestioned institution that was maintained *in perpetuity* by the Royal Academy of Sciences/Royal Society, and universities such as Oxford and Cambridge. There was no easy way to change such a world of thinking, though new papers could easily be written and circulated (they were not as suppressed as they are today).

However, when Faraday proposed the existence of electromagnetic waves which propagated through the air, through metal, through water... it was hailed as a solution for the Aether as well as absolute heresy.¹¹⁰

One of the consequences, though, of good pragmatic experiment, was the introduction of the concept of radio waves by Maxwell.¹¹¹ While it would be some time before radio waves would be usable, and for microphones and speakers to be developed, this was the first time that the EMF was found to propagate not as a fluid in a pipe (a conductive wire) but throughout *everything*.

The contributions of such men towards a unified theory was, for one reason or another, not hailed as the final solution to the Aether issue. Perhaps because their contributions came ahead, rather than behind the Michelson-Morley Experiment by several decades. It was upon their work that the next generation of super geniuses such as Tesla, Birkeland, Poincare, Merconi, Langmuir, and Steinmetz would base their spectacularly brilliant careers.

Gauss, Ampere, and Kirchhoff

It's easy, within the shadow of legends such as Faraday and Maxwell, to lose site of some other heavy hitters in electromagnetic history. Gauss was a pre-eminent mathematician, as well as physicist, whose contributions included discussions of curvature and curl, and distribution, among other things.¹¹² However, his early work on magnetism provided a solid foundation for the field in the future. It was not known at that time that the work would in fact become part of a series of laws that described classical electromagnetism, but it was believed to be a work of supreme elegance.¹¹³

¹¹⁰ *Lives and Times of Great Pioneers in Chemistry (Lavoisier to Sanger)*. World Scientific. 2015. p. 85, 86

¹¹¹ https://en.wikipedia.org/wiki/Radio_wave#Discovery_and_exploitation

¹¹² https://en.wikipedia.org/wiki/List_of_things_named_after_Carl_Friedrich_Gauss

¹¹³ https://en.wikipedia.org/wiki/Carl_Friedrich_Gauss#Appraisal

He made his contributions to magnetics starting in 1831, and without his help, the work of Ampere and Kirchhoff, who had studied the work of Faraday's induction machine¹¹⁴, would not have been possible.¹¹⁵ The advancement of circuits and circuit mathematics was absolutely essential for humanity's future. This paper, as well as every technical thing done these days, down to the simplest calculators all rely upon the electric circuit.

Ampere and Kirchhoff both formulated various laws which were not, in the ultimate surmise, totally correct. However, with Maxwell's correction, Ampere's Law has remained attributed to him, and is still essential to the circuit.¹¹⁶ Kirchhoff's circuit laws have survived, but his thermodynamic law is under fire for not completely describing the issue of black body radiation¹¹⁷; a type of EMF that is beyond the scope of this paper.

¹¹⁸ ¹¹⁹ ¹²⁰

However, though these men worked on unilinear circuits, the ideas they have used became useful 100 years later in the 1950s and 1960s when Langmuir, Juergens, and others began to describe the Solar System Circuit (SSC) and various circuit component features such as the capacitance and inductance of radiative belts¹²¹ ¹²², the voltages of celestial bodies¹²³, the anodes and cathodes in the solar wind¹²⁴ ¹²⁵, and the transistor behaviors of the sun itself.¹²⁶ ¹²⁷ ¹²⁸ ¹²⁹ ¹³⁰

¹¹⁴ Aka "Faraday Disk" https://en.wikipedia.org/wiki/Faraday%27s_law_of_induction

¹¹⁵ "So the "flux rule" that the EMF in a circuit is equal to the rate of change of the magnetic flux through the circuit applies whether the flux changes because the field changes or because the circuit moves (or both) ... Yet in our explanation of the rule we have used two completely distinct laws for the two cases – $\mathbf{v} \times \mathbf{B}$ for "circuit moves" and $\nabla \times \mathbf{E} = -\partial_t \mathbf{B}$ for "field changes". We know of no other place in physics where such a simple and accurate general principle requires for its real understanding an analysis in terms of *two different phenomena*." Richard P. Feynman, *The Feynman Lectures on Physics*

¹¹⁶ Appendix B.IV.10

¹¹⁷ <https://sites.google.com/site/electricuniversegateway/recent-news/whatiskirchoffslaw>

<https://sites.google.com/site/electricuniversegateway/recent-news/iskirchoffslawtrue>

<https://sites.google.com/site/electricuniversegateway/recent-news/kirchoffslaw-2ndexperiment>

<https://sites.google.com/site/electricuniversegateway/recent-news/kirchoffplanckandcarbonparticle>

<https://sites.google.com/site/electricuniversegateway/recent-news/kirchoffslawandboxinabox>

<https://sites.google.com/site/electricuniversegateway/recent-news/kirchoffvs2ndlawofthermodynamics>

<https://sites.google.com/site/electricuniversegateway/recent-news/kirchoffsclaimseu2015-drrorbitaille>

¹¹⁸ <https://arxiv.org/abs/physics/0507007>

¹¹⁹ <http://www.ptep-online.com/2008/PP-14-07.PDF>

¹²⁰

https://www.researchgate.net/publication/26842355_Blackbody_Radiation_and_the_Loss_of_Universality_Implications_for_Planck's_Formulation_and_Boltzman's_Constant

¹²¹ https://www.youtube.com/watch?v=QiM_gLRluGc

¹²² http://worldnpa.org/wp-content/uploads/2015/06/Leybourne_Gregori_NPAproceedings_2014.pdf

¹²³ <http://mclarage.blogspot.se/2016/08/the-solar-system-as-electrical.html>

¹²⁴ <https://www.everythingselectric.com/ralph-juergens/>

¹²⁵ <https://www.youtube.com/watch?v=JST8NHoAAcA>

¹²⁶ <https://electric-cosmos.org/Electronic%20Sun.pdf>

¹²⁷ <https://www.youtube.com/watch?v=sFGb7NIUvgg>

¹²⁸ https://www.youtube.com/watch?v=71rA_361RrXy

¹²⁹ <https://www.youtube.com/watch?v=5MvAnECkaME>

¹³⁰ <https://www.youtube.com/watch?v=JsfEG4HzWAY>

Heaviside

These days EM in physics and engineering has had a number of corrections and simplifications:

Table 3 - Maxwell's vs Heaviside's Equations, side by side comparison

Maxwell's equations		Heaviside's equations	
ϵ_0	$8.855 \cdot 10^{-12} \text{ m}^{-3} \cdot \text{kg}^{-1} \cdot \text{s}^4 \cdot \text{A}^2$	g_0	$1.193 \cdot 10^9 \text{ m}^{-3} \cdot \text{kg} \cdot \text{s}^2$
μ_0	$1.257 \cdot 10^{-6} \text{ m} \cdot \text{kg} \cdot \text{s}^{-2} \cdot \text{A}^{-2}$	s_0	$0.9329 \cdot 10^{-26} \text{ m} \cdot \text{kg}^{-1}$
ρ_E	$\text{m}^{-3} \cdot \text{s} \cdot \text{A} = \text{Kl}/\text{m}^3$	ρ_G	$\text{m}^{-3} \cdot \text{kg} = \text{kg}/\text{m}^3$
\mathbf{J}_E	$\text{m}^{-2} \cdot \text{A} = \text{A}/\text{m}^2$	\mathbf{J}_G	$\text{m}^{-2} \cdot \text{kg} \cdot \text{s}^{-1} = \frac{\text{kg} \cdot \text{m} \cdot \text{s}^{-1}}{\text{m}^3}$
\mathbf{P}_E	$\text{m}^{-2} \cdot \text{s} \cdot \text{A} = \frac{\text{Kl} \cdot \text{m}}{\text{m}^3}$	\mathbf{P}_G	$\text{m}^{-2} \cdot \text{kg} = \frac{\text{kg} \cdot \text{m}}{\text{m}^3}$
\mathbf{P}_M	$\text{m}^{-1} \cdot \text{A} = \frac{\text{A} \cdot \text{m}^2}{\text{m}^3}$	\mathbf{P}_S	$\text{m}^{-1} \cdot \text{kg} \cdot \text{s}^{-1} = \frac{\text{kg} \cdot \text{m}^2 \cdot \text{s}^{-1}}{\text{m}^3}$
\mathbf{E}	$\text{m} \cdot \text{kg} \cdot \text{s}^{-3} \cdot \text{A}^{-1} = \frac{\text{kg}}{\text{Kl}} (\text{m} \cdot \text{s}^{-2})$	\mathbf{G}	$\text{m} \cdot \text{s}^{-2}$
\mathbf{M}	$\text{Kg} \cdot \text{s}^{-2} \cdot \text{A}^{-1} = \frac{\text{kg}}{\text{Kl}} (\text{s}^{-1})$	\mathbf{S}	s^{-1}

Table 4 - Maxwell in Differential and Integral form, developed by Heaviside

Name	Differential form	Integral form
Gauss's law	$\nabla \cdot \mathbf{E} = \frac{\rho}{\epsilon_0}$	$\oiint_{\partial V} \mathbf{E} \cdot d\mathbf{A} = \frac{Q(V)}{\epsilon_0}$
Gauss's law for magnetism	$\nabla \cdot \mathbf{B} = 0$	$\oiint_{\partial V} \mathbf{B} \cdot d\mathbf{A} = 0$
Maxwell-Faraday equation (Faraday's law of induction)	$\nabla \times \mathbf{E} = -\frac{\partial \mathbf{B}}{\partial t}$	$\oint_{\partial S} \mathbf{E} \cdot d\mathbf{l} = -\frac{\partial \Phi_{B,S}}{\partial t}$
Ampère's circuital law (with Maxwell's correction)	$\nabla \times \mathbf{B} = \mu_0 \mathbf{J} + \mu_0 \epsilon_0 \frac{\partial \mathbf{E}}{\partial t}$	$\oint_{\partial S} \mathbf{B} \cdot d\mathbf{l} = \mu_0 I_S + \mu_0 \epsilon_0 \frac{\partial \Phi_{E,S}}{\partial t}$

Table 5 - Original Maxwell and Modern Scalar Notation

Variable Name Used by Maxwell (Equivalent Modern Name)	Symbol Used by Maxwell	Modern Equivalent Vector/Scalar
Electromagnetic Momentum (Magnetic Vector Potential)	F, G, H	\vec{A}
Magnetic Force (Magnetic Field Intensity)	α, β, γ	\vec{H}
Electromotive Force (Electric Field Intensity)	P, Q, R	\vec{E}
Current Due to True Conduction (Conduction Current Density)	p, q, r	\vec{J}
Electric Displacement (Electric Flux Density)	f, g, h	\vec{D}
Total Current Including Variation of Displacement (Conduction plus Displacement Current Density)	$\left\{ \begin{array}{l} p^1 = p + \frac{df}{dt} \\ q^1 = q + \frac{dg}{dt} \\ r^1 = r + \frac{dh}{dt} \end{array} \right.$	\vec{J}_T
Quantity of Free Electricity (Volume Density of Electric Charge)	e	ρ
Electric Potential (Electric Scalar Potential)	ψ	ψ

Oliver Heaviside's simplifications have greatly enhanced the usability of the equations, while making a number of small or minor improvements.

At the time, Maxwell, Gauss and Faraday's understanding of electricity and magnetism was not necessarily an opinion shared by all. Heaviside was able to bolster their conclusions by providing a much needed "third opinion" on the unification issue. This was done with flux vector analysis.¹³¹

He also enabled massive improvements to the world's telegraph systems as well as predicted a layer in the ionosphere, now called the Kennelly-Heaviside layer. He invented the coaxial cable as well as the vector analysis to describe it.¹³²

However, regardless of these progresses, they do remain dependent on the use of complex numbers, which invoke the imaginary number i , which is to say, an undefined number, or impossible number.

Recently, Robert Distinti has clarified this and corrected the geometric algebra with his Votrix © Algebra (see below) in order to provide a mechanism for i to exist.¹³³ He has also introduced new and improved versions of Heaviside's formulas (see New Electromagnetism, table 5).

¹³¹ https://en.wikipedia.org/wiki/Oliver_Heaviside

¹³² Yes he is the man ultimately responsible for cable TV.

¹³³ <https://www.youtube.com/watch?v=z6iEUXTPVIA>

Tesla-Steinmetz

Although other men made more foundational, theoretical contributions, or were as successful invention-wise, perhaps no two men more acted as the epitome of Euler/Gauss level genius, Bohr/Poincare level insight, and Edison/Franklin level of achievement than Nikola Tesla and Charles “Proteus” Steinmetz. Steinmetz, however, was utilized in full at General Electric, and retained the pre-eminent respect of his colleagues, the establishment, and with full funding until the end of his life.¹³⁴ Whereas Tesla, for the sin of giving up his billion-dollar patents on the AC motor/generator, and transformer,¹³⁵ and despite having 300 patents,¹³⁶ died penniless and mostly alone, and his remaining work was essentially stolen by the FBI on behalf of certain vested powers¹³⁷ in order to prevent his ideas about wireless power and communications from being spread.¹³⁸ To this day many people doubt his theories on these ideas, despite the fulfillment of every prophecy contained in his autobiography which was written prior to the second world war.¹³⁹

The two men were colleagues, and at one time friends,¹⁴⁰ working on AC three-phase power¹⁴¹ for the fledgling General Electric (see figure 8). But while Proteus was used by Thomas Edison,¹⁴² Tesla warred with Edison, and made a fool of him publicly by revealing some of the misleading ideas he had presented about the DC current versus AC.¹⁴³ This did not win Tesla any favors, even with the competitors of Edison.¹⁴⁴ He also did not play well with some of the ‘lesser geniuses’ of the day, such as Marconi.¹⁴⁵

Later, when Tesla agreed to meet with the US Government to discuss his ideas for the teleautomaton¹⁴⁶ (AI robot), and RF controlled weapons,¹⁴⁷ he was met with coldness and disinterest, and he decided to take his “best ideas”¹⁴⁸ to the grave with him, including the infamous “earthquake machine” that fit inside his pocket.¹⁴⁹ He eventually became a mystic¹⁵⁰ and a recluse, preferring the company of pigeons to that of people.¹⁵¹ He never married, and had no heirs, much like later genius Edward Leedskalnin. In a later section we shall explore his ideas of electrogravitics¹⁵² as a comparison with Leedskalnin’s magnetic-gravitics.

¹³⁴ <http://www.edisontechcenter.org/CharlesProteusSteinmetz.html>

¹³⁵ <https://www.smithsonianmag.com/history/the-rise-and-fall-of-nikola-tesla-and-his-tower-11074324/>

¹³⁶ https://en.wikipedia.org/wiki/List_of_Nikola_Tesla_patents

¹³⁷ Westinghouse, General Electric, Edison, etc...

¹³⁸ Anyone threatened by the end of wired-telegraphy and power by fossil fuels, which Tesla had previously stated that “Burning fuel to generate energy is barbaric.” In the light of the modern environmental crises: the author must agree.

¹³⁹ The coming of world war 2, of massive super-weapons and MAD (although it isn’t clear he predicted the atom bomb itself), of robots, rockets, the internet, the harm to society and family by feminism, the league of nations, and wireless communications and media/music transfer, fax, digital photographs, most of which was contained within two pages of his autobiography. http://www.tfcbooks.com/e-books/my_inventions.pdf

¹⁴⁰ <http://now.northropgrumman.com/charles-steinmetz-electrifies-the-modern-world/>

¹⁴¹ <https://patents.google.com/patent/US533244>

¹⁴² *ibid.*

¹⁴³ Unironically Edison had used DC to kill animals, saying it was AC. Tesla demonstrated how safe AC was, and Edison sold his machine as the electric chair, and made a fortune in capital punishment. As it turns out, DC was not only able to kill people, it was also cruel and sometimes ineffective.

¹⁴⁴ <http://www.teslasautobiography.com/>

¹⁴⁵ ‘Marconi is a good fellow. Let him continue. He is using seventeen of my patents.’ ~Tesla

¹⁴⁶ *Ibid.* pg 27+

¹⁴⁷ “By installing proper plants it will be practicable to project a missile of this kind into the air and drop it almost on the very spot designated, which may be thousands of miles away.” *Ibid.* Pg. 34

¹⁴⁸ Such as his Tesla Tower and the secrets of pumping the Earth with millions of volts and wireless telegraphy.

¹⁴⁹ https://en.wikipedia.org/wiki/Tesla%27s_oscillator

¹⁵⁰ <https://www.history.com/news/9-things-you-may-not-know-about-nikola-tesla>

¹⁵¹ <https://teslauniverse.com/nikola-tesla/timeline/1922-teslas-favorite-pigeon-dies>

¹⁵² <http://www.netowne.com/technology/important/>

The main benefit that Tesla provided for the modern world was the AC current and accompanying devices, such as the transformer. However, it was Steinmetz, and his brilliance with mathematics that enabled him to actually transform the world and the industry of America into a pre-war powerhouse.¹⁵³



Figure 8 - Pictured center, moving right, Einstein, Tesla, and Steinmetz (in white), 1921

Birkeland-Marklund

Though these two did not work directly together¹⁵⁴, they did formulate the basis of plasma electric current understanding (many years in advance of NASA and the re-interpretation) of what have become known as “magnetic flux ropes” or “portals” or “tubes.” Their initial study of plasma, using laboratory equipment such as the planetary terrella, the langmuir probe, and vacuum tubes, led to a decades-ahead-of-its-time understanding of a cosmic mystery: the Birkeland Current (see Appendix A), and an accompanying model¹⁵⁵. While Feynman chose to focus on single dimensional current in coaxial shapes, and generalized electromagnetic fields, Marklund has demonstrated that electromagnetic plasmas did not behave linearly¹⁵⁶, nor even in singular tubes, but in paired ropes.¹⁵⁷ See Figure 9.

The process, Marklund Convection¹⁵⁸, was repeatedly demonstrated to lead to the behavior known as Bennett pinching or Z-pinching. Also known simply as pinching, the process has also been demonstrated in

¹⁵³ https://granderiver.owschools.com/media/o_rla06_ccss_2016/2/charles_steinmetz_master_of_electricity.pdf

¹⁵⁴ Kristian Birkeland (1867-1917); Göran Marklund is currently alive and still working on “Black Aurorae”

<http://www.sciencemag.org/news/2001/12/lifting-veil-black-aurorae>

¹⁵⁵ <https://www.everythingselectric.com/marklund-convection/>

¹⁵⁶ <https://youtu.be/sIQRBrmEIXo>

¹⁵⁷ <https://www.everythingselectric.com/birkeland-currents/>

¹⁵⁸ “Plasma convection in force-free magnetic fields as a mechanism for chemical separation in cosmical plasma”. *Nature*. **277**: 370–371., G Marklund, 1979

electromagnetic compression experiments which explosively implode cans instantly, leaving two bell-shaped halves.

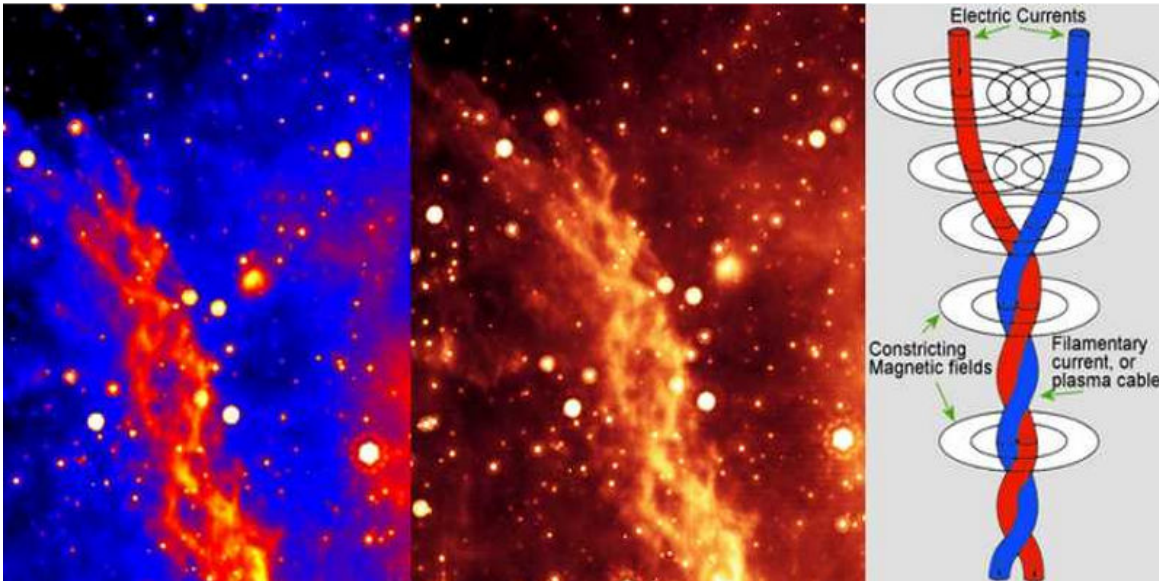

Figure 9 - Birkeland Currents in double-helix shape¹⁵⁹; credit: everythingselectric.com

The author will herein assert that this process' full scale has not been understood (or at least publicly postulated) by anyone in any of the communities in or out of the plasma-electric Universe cosmologies or high energy physics. The reason why massive gravity¹⁶⁰ has been detected in SGR A*, in the center of our Milky Way, but it fails habitually to destroy loose clouds of dust or gas¹⁶¹, and instead throws off massive amounts of ionized, high velocity gases¹⁶², is not merely a Z-pinch, but a massive electromagnetic pinch that represents a macro-level (Supergalactic Electric Circuit or SGENC) Marklund Convection which is compressing "SGR A*" into a *literally invisible* (non-existent) point, that happens to be acting as a center of mass, and a fusion center for all sorts of matter¹⁶³ and radiation. The "Supermassive Black Hole" 'exists' as a magnetic compression point, much as the center of the can (see Figure 10).

But while there is no singularity¹⁶⁴, and no "black hole" as such¹⁶⁵, the electromagnetic forces at these nexus points is inconceivably powerful. It would also explain where there "appears to be 10,000 black holes in the center of the Milky Way."¹⁶⁶ Of course this is quite nonsensical.

There are, however, probably *billions* of massive Z-pinch formations in any given galaxy. Some are undergoing massive Marklund Convection in the form of charging stars, some are in "empty" spaces, leaving many bodies of liquid hydrogen and helium out there behaving as black body celestial exoplanets¹⁶⁷, Y-dwarfs, and dark or "dead" stars¹⁶⁸. Like people, plants, situations, projects, and anything else... they can exist within the Flux, or outside. But they will only be bright, charged, and life-producing within the Flux of the Unified Aether Field or simply: Unified Field (the EMF-UF).

¹⁵⁹ This is the *real* reason DNA is in a double-helix shape.

¹⁶⁰ Read: electro-gravity; literally extra energy-mass meaning more weight.

¹⁶¹ <https://www.seeker.com/why-our-galaxys-black-hole-didnt-eat-that-mystery-object-1769260654.html>

¹⁶² https://www.nasa.gov/mission_pages/chandra/news/high-energy-particles-in-milky-way.html

¹⁶³ <https://www.space.com/1670-astronomers-surprised-stars-born-black-hole.html>

¹⁶⁴ Literally, Einstein's 1 mass system makes no sense, and one cannot divide by 0. (see Crothers)

¹⁶⁵ They can't even exist in a Big Bang mathematical Universe. They are literally mathematically exclusive.

¹⁶⁶ <https://www.newscientist.com/article/2165505-the-centre-of-our-galaxy-may-be-swarming-with-10000-black-holes/>

¹⁶⁷ <https://arxiv.org/pdf/1804.05334.pdf>

¹⁶⁸ While Y-dwarfs are considered "failed stars" (as if they were attempting things like people do), "dead" stars are supposed to have burned out. This is, of course, a droll and simplistic explanation of a body which has a very low voltage and current (as compared to other stars).

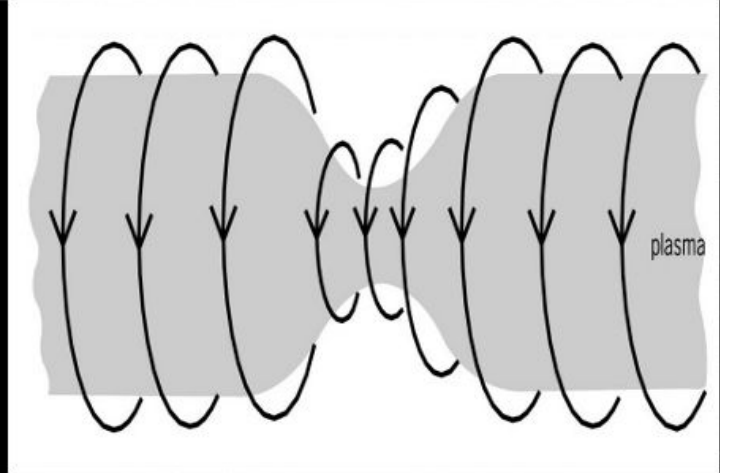
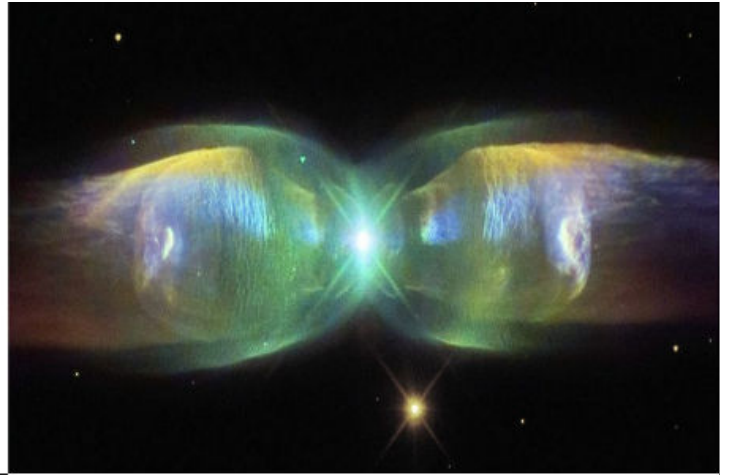
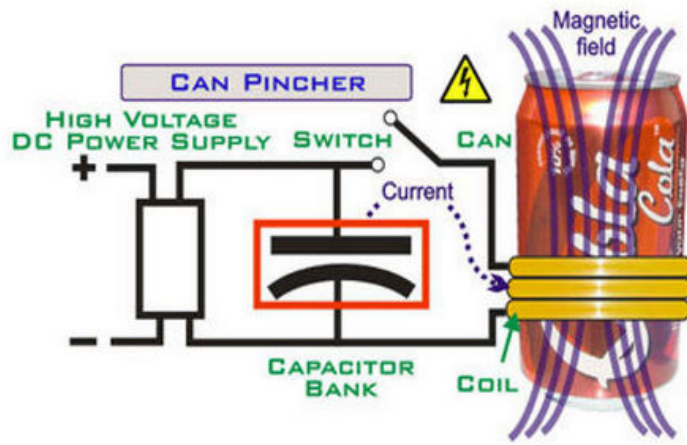

Figure 10 - Z-pinch, circuit, and forces explained, compared with Nebulae; credit: everythingselectric.com

Poincare

Around the turn of the 19th to 20th century, a rare type of fraud and/or oversight occurred, which was made easier by the lack of television, internet, and long distance telephone calls being common. In 1905¹⁶⁹, while researching and discussing invariance with mathematician Hendrik Lorentz, Poincare happened upon both relativity and gravity waves¹⁷⁰. His work was discussed in small academic circles, especially amongst other mathematicians. Then the work was being researched by either Einstein himself or possibly his then-wife, Mileva Marić¹⁷¹ and wound up in his (Einstein's) paper on Special Relativity, which won the Nobel Prize in 1922, 10 years after the sudden death of Henri Poincare, the actual predictor of gravity waves.¹⁷²

Henri Poincare, however, was not in the business of proposing peculiar ideas of combining space and time.¹⁷³ His own work was in electromagnetism's Maxwell's Laws, as they pertained to a mathematical issue of Lorentz Transformations¹⁷⁴. For example, as regards the Michelson-Morley experiment, Poincare was the first to introduce length contraction (dilation).¹⁷⁵ He also suggested setting the speed of light to a constant, and

¹⁶⁹ 11 years before Einstein's Theory of General Relativity (1916)

¹⁷⁰ https://en.wikipedia.org/wiki/Henri_Poincar%C3%A9

¹⁷¹ https://en.wikipedia.org/wiki/Mileva_Mari%C4%87#Debate_over_collaboration_with_Einstein

¹⁷² https://en.wikipedia.org/wiki/Gravitational_wave

¹⁷³ Or "transfinite numbers" which are obviously a ridiculous idea: infinity is not a number and any % of infinity is still infinity.

¹⁷⁴ Ibid.

¹⁷⁵ Ibid.

introduced the relativistic idea of “local time.”¹⁷⁶ He even called the idea the “principle of relativity” in 1904.¹⁷⁷ He happened upon the issue of four dimensional Lorentzian rotation and decided not to pursue it in 1907.¹⁷⁸

He was not the first to find the relationship between electromagnetism and energy-mass,¹⁷⁹ but while he was studying the aether, he noticed that *electromagnetic waves carry their own momentum*.¹⁸⁰ This led him to conclude it behaves like a fictitious fluid, with a mass density of E/c^2 .¹⁸¹ This left room for Einstein’s “space-time,” but Poincare only believed it to be a matter of mathematical fancy.¹⁸² Unfortunately, he did not see the wave-particle duality, or that energy is literally mass, or rather that mass is naught but energy in varying frequencies. It must be recalled that Quantum Mechanics was in its fledgling infancy and was not at all considered a likely candidate for explanations, and it is unlikely he was even aware of it at any rate.¹⁸³ Poincare opted instead to agree with Sino-Vedic sciences and metaphysics, in declaring that mass was not “real.”¹⁸⁴

At any rate, Einstein published his own equivalent solutions in 1906, and made this declaration, that $m = E/c^2$. However, as Poincare had published his short work first, but the long work after, Poincare never acknowledged Einstein, and Einstein never acknowledged that Poincare was first in relativity (or that he had obviously read the 1898 work on relativity.)¹⁸⁵

He was also famous for his work on the Three-body Problem¹⁸⁶, and for leaving difficult to solve problems, as well as providing a number of differential calculus enhancements, such as the Poincare Map.¹⁸⁷ He also introduced Fundamental Group theory to physics.¹⁸⁸

Kirchhoff

Gustav Kirchhoff was a Prussian physicist and chemist¹⁸⁹ who provided the most fundamental of circuit laws, which, combined with “Ohm’s Law” form the basis of how we understand electrical circuits.¹⁹⁰ More importantly in the discussion of induction, transformers, and the PEMS/HEGEME hypothesis (of the Electrothermal Vine)¹⁹¹, wherein Earth behaves as a capacitor, inductor¹⁹², and stellar transformer¹⁹³, his work enabled future understanding of AC transformation and power transfer.

¹⁷⁶ Ibid.

¹⁷⁷ Ibid.

¹⁷⁸ 9 years prior to General Relativity.

¹⁷⁹ 1881, JJ Thomson, https://en.wikipedia.org/wiki/Electromagnetic_mass

¹⁸⁰ As they need no medium to travel - hint that EMF is the UAF

¹⁸¹ He used Aether to explain Hertzian losses.

¹⁸² Four dimensional physics *is* a fantasy, without an etheric dimension. Einstein’s *genius* was to provide an aether that fulfilled a need *after* Michelson-Morley; but it was also fraudulent in that space and time are not dimensions of a relationship. Although relativity is true, in terms of **age** in light (see Halton Arp, Intrinsic Red Shift), it is not that time is attached inexplicably to space’s three dimensions! Stretching mathematical space is a mathematical concept, but people have been led to believe that physical space bends or stretches. Or that there is a physical time that bends. This type of misunderstanding of mathematical fancy is unfortunately common. However, for all belief that microlensing has been found, in actuality none has, merely plasma related refraction in the solar corona and galactic/nebula gas fields (plasma-electromagnetic current sheaths). See later sections. As for actual fraud, the author leaves that to the reader to consider, after reviewing the facts, and considering the work of Stephen Crothers.

¹⁸³ 1877 or 1900, both very obscure papers.

¹⁸⁴ “Henri Poincaré in 1906 argued that when mass is in fact the product of the electromagnetic field in the aether – implying that no “real” mass exists – and because matter is inseparably connected with mass, then also matter doesn’t exist at all and electrons are only concavities in the aether.” Ibid.

¹⁸⁵ Ibid.

¹⁸⁶ https://en.wikipedia.org/wiki/Three-body_problem

¹⁸⁷ https://en.wikipedia.org/wiki/Poincar%C3%A9_map

¹⁸⁸ <http://felix.physics.sunysb.edu/~abanov/Teaching/Spring2009/Notes/abanov-cpA1-upload.pdf>

¹⁸⁹ https://en.wikipedia.org/wiki/Gustav_Kirchhoff

¹⁹⁰ Appendix B.IV.7-9

¹⁹¹ [4]

¹⁹² https://drive.google.com/file/d/0ByRZ_FN_vit_b3AzSEIPblAxbE0/view

¹⁹³ https://www.youtube.com/watch?v=QiM_gLRluGc

Robitaille vs. Kirchhoff

As mentioned before, Dr. Robitaille has, in the modern landscape, rigorously scrutinized the foundations of Kirchhoff's law, as pertains to black body radiation issues. It is best to let him speak for himself, and he has several papers on the subject:

- Kirchhoff's Law of Thermal Emission: 150 Years
- http://www.ptep-online.com/index_files/2009/PP-19-01.PDF
- Blackbody radiation and the carbon particle, Prog. in Phys., 2008, v. 3, 36–55
- http://www.ptep-online.com/index_files/2008/PP-14-07.PDF
- On the validity of Kirchhoff's law of thermal emission. IEEE Trans. Plasma Sci., 2003, v. 31(6), 1263–1267
- <https://ieeexplore.ieee.org/document/1265348/>
- An analysis of universality in blackbody radiation. Progr. in Phys., 2006, v. 2, 22–23
- http://www.ptep-online.com/index_files/2006/PP-05-05.PDF
- On the Equation which Governs Cavity Radiation (Letters to Progress in Physics)
- http://www.ptep-online.com/index_files/2014/PP-37-15.PDF
- A Critical Analysis of Universality and Kirchhoff's Law: A Return to Stewart's Law of Thermal Emission
- http://www.ptep-online.com/index_files/2008/PP-14-06.PDF
- <https://arxiv.org/abs/0805.1625>
- Further Insight Relative to Cavity Radiation: A Thought Experiment Refuting Kirchhoff's Law
- http://www.ptep-online.com/index_files/2014/PP-36-11.PDF
- A Re-examination of Kirchhoff's Law of Thermal Radiation in Relation to Recent Criticisms
- <http://www.ptep-online.com/2016/PP-46-03.PDF>

The reader may be curious why these are listed in main rather than in footnotes. Not only is this to highlight them, but to highlight that not too many serious critiques or rebuttals have been mounted against the works presented, which are clearly very detailed and require intense dissection, and not mere dismissal.²⁰⁰ The author has no intent to defend the works, only to point out that dismissal-out-of-hand²⁰¹ because something is *old* is not acceptable in science, and is never a valid argument in and of itself. Neither is name-calling (*ad hominem*)²⁰².

Such an issue will be revisited in the next section regarding New Electromagnetism.

For now, utilizing the Law of Scientific Acquisition that laboratory demonstration trumps verbal theory, the author considers the point closed, and Kirchhoff's Law must be considered invalid, until proven otherwise.²⁰³ Believe it or not, it was never proven in the first place²⁰⁴, without the placement of a black body in the cavity (thus affecting the outcome).

Jeurgens-Scott

The primary treatise of the Jeurgens-Scott hypotheses is contained in the EPEMC paper, "Plasma-Electromagnetic Sky..." by the author.²⁰⁵

What must be covered here is a discussion of the ramifications of counter-rotational electromagnetic fields. See Figure 12 and 13.

²⁰⁰ https://www.researchgate.net/post/Is_Kirchhoffs_law_of_thermal_emission_now_dead

²⁰¹ <http://www.rationalskepticism.org/pseudoscience/kirchhoff-s-law-of-thermal-emission-invalid-t48606.html>

²⁰² https://rationalwiki.org/wiki/Pierre-Marie_Robitaille <- detestable and cowardly.

²⁰³ <https://www.libertariannews.org/2014/04/04/kirchhoffs-law-proven-invalid-the-implications-are-enormous/>

²⁰⁴ It was stated as true, and supported by Lord Kelvin, and therefore it became "true".

²⁰⁵ [4]

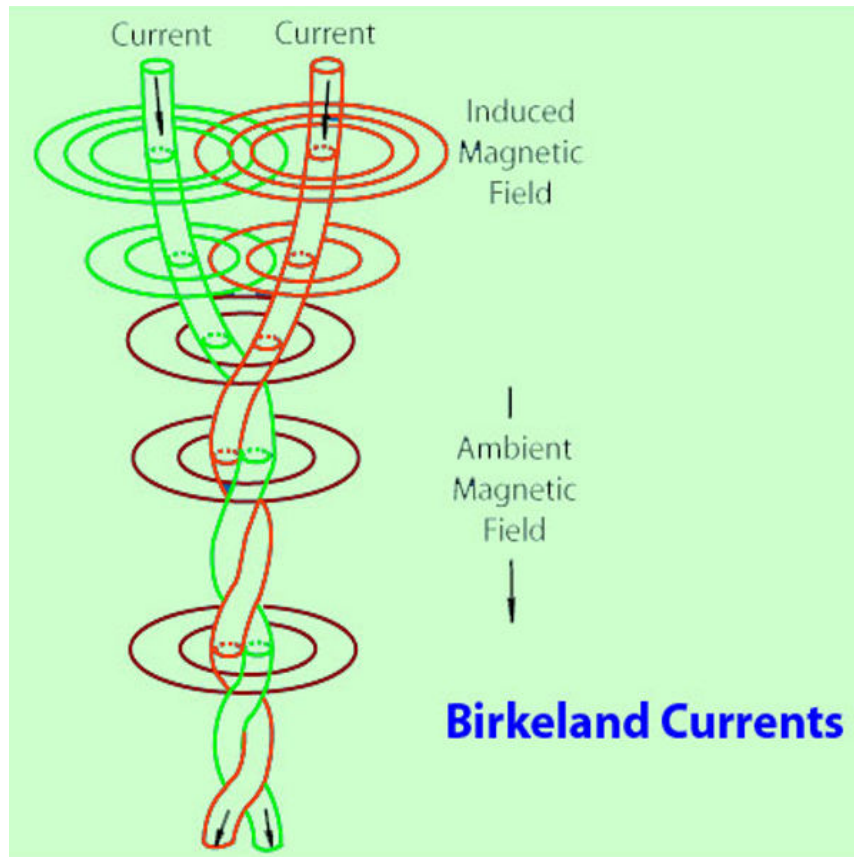

Figure 12 - Birkeland Current Twist; credit: everythingselectric.com²⁰⁶

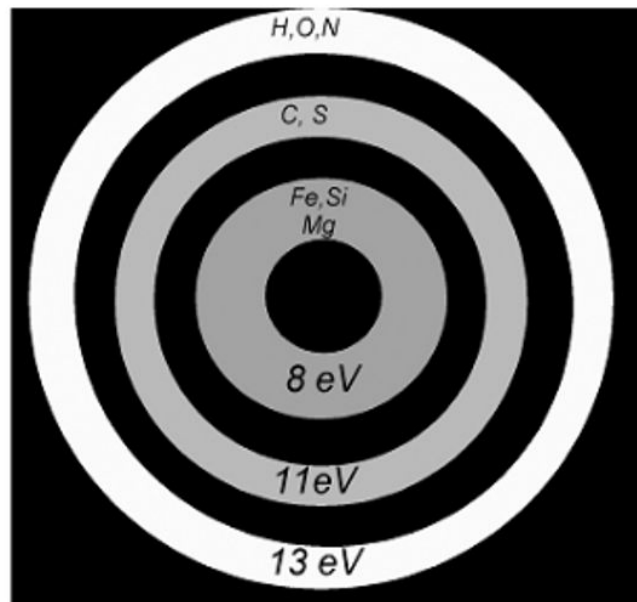

Fig. 4. Elements form into concentric cylinders in a Birkeland current. Radii are proportional to their ionization voltage.

Figure 13 - Ionization shells in Birkeland currents; credit: D Scott²⁰⁷

²⁰⁶ <https://www.everythingselectric.com/birkeland-currents/>

²⁰⁷ <http://www.ptep-online.com/2018/PP-53-01.PDF>

Feynman was not *completely* incorrect in his application of single directional Electric field differential equations (although Birkeland Currents twist and distort, as mentioned in the Marklund subsection). These co-axial rotational structures form unique shell currents²⁰⁸ that undoubtedly also have hysteresis effects throughout which enable them to carry forward at a much more efficient degradation rate than Feynman's $1/r$, or than an E-field ($1/r^3$).

Instead they propagate at $r^{1/2}$ (root(r)). This is astounding. In the following pages, some of the equation derivations from Donald Scott's landmark paper will be cited²⁰⁹, and followed with more figures regarding propagation efficiency (calculations from the author).

"A level of interest did, however, develop regarding the Sun's photosphere and plasma properties of the solar corona. For example, a mathematical model of a force-free magnetic field was proposed as early as 1950 by Lundquist [3, 4]. He investigated whether magnetic fields could exist in an electrically conducting liquid and his results included presentation of the now well-known Bessel solution for force-free fields. Later in 1957, investigators such as Chandrasekhar and Kendall [5] applied a similar analysis to the spherical geometry of the Sun. NASA scientists and many other investigators worked on Birkeland currents and flux rope observations since the mid to-late 1960's [6–18], with substantial activity on this topic after the late 1980's [19–24]. A few researchers have sought cylindrical coordinate solutions [25] but almost always in reference to intricate quasi-cylindrical solar surface or coronal applications. Potemra [24] concluded that Birkeland currents and Alfvén waves are fundamental to an understanding of the Earth's plasma environment. It is now generally assumed that magnetic fields inside interplanetary magnetic clouds and flux ropes in the solar photosphere are force-free [26]. In 2009, space probe Themis discovered a flux rope pumping a 650,000 A current down into the arctic auroral region [27]. This strong observational evidence supports the existence of Birkeland Currents..." [sic]

$$1. (\nabla \times B) \times B = \mu_0 \nabla p \quad (1)$$

$$2. \beta = 2\mu_0 p/B^2 \quad (2)$$

$$3. F = q (E + v \times B) \quad (3)$$

$$4. \nabla \times B = \mu (j + \epsilon \partial E / \partial t) \quad (4)$$

$$5. B_\theta = \mu I / (2\pi R) \quad (6)$$

$$6. F_L = qvB \sin \phi \quad (7)$$

$$7. \psi = \frac{1}{2} I^2 (\mu N^2 A_c / l) \quad (10)$$

$$8. q (v \times B) = j \times B = 0 \quad (11)$$

$$9. (\nabla \times B) \times B = 0 \quad (12)$$

$$10. \mu = |B/H| = W_b / m^2 * m/A = W_b / m/A \quad (17)$$

$$11. [\nabla \times B] = \mu j = W_b / m^3 \quad (18)$$

$$12. \partial B_z / \partial r = -\alpha B_\theta \quad (24) \text{ "In the azimuthal direction"}$$

$$13. 1/r \partial / \partial r (r B_\theta) = \alpha B_z \quad (25) \text{ "in the axial direction"}$$

"An Euler/Runge-Kutta algorithm for obtaining an approximate step-wise solution to (36) and (37) was implemented. The results, presented in Figure [14], show, as expected, the familiar shapes of Bessel functions J_0 and J_1 as $B_z(r)$ the axial component, and $B_\theta(r)$ the azimuthal component. Also shown is the total magnetic field strength $|B|$ (the square root of the sum of the squares of the two component scalar fields, B_z and B_θ). This total field strength magnitude is strongest at a minimum radial value r and decreases monotonically with increasing r . Specifically, in Figure 2, total magnetic field magnitude is shown to decrease with increasing radial distance from the central axis of the current as $(ar)^{-1/2}$. This function is shown, for reference, as the fourth series plotted in Figure 2. This behavior was fully described in Section 4 (see (31)). Therefore, the magnetic fields within field-aligned

²⁰⁸ Distinti calls them "Edge currents"

²⁰⁹ Birkeland Currents: A Force-Free Field-Aligned Model, D. Scott, 2015 <http://www.ptep-online.com/2015/PP-41-13.PDF>

cosmic currents clearly extend outward in space much farther and less diminished in strength than the magnetic field that would be generated by a simple straight-wire electric current..." (emphasis by author, not Scott)

The meat of the calculus is contained in original work.

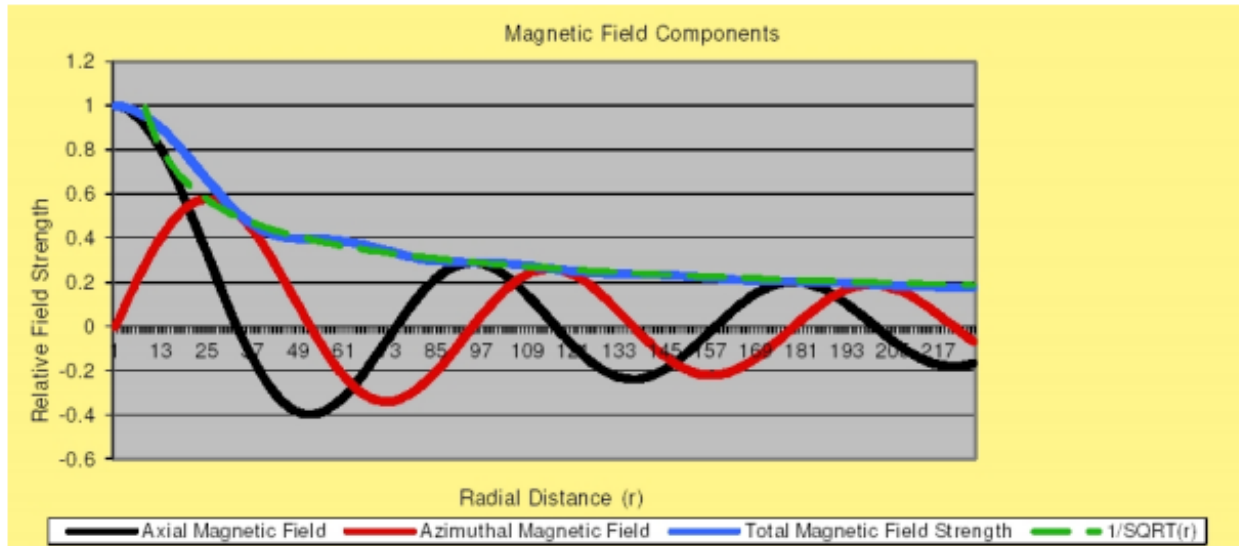

Fig. 2: Axial Magnetic Field component B_z , the Azimuthal Magnetic Field component B_θ , the magnitude of the Total Magnetic Field; and, for reference, a plot of $1/\sqrt{r}$ – all vs. radial distance quantized to integer multiples of the step-size $h = 0.1$. The value of α arbitrarily selected in (36) and (37) to achieve adequate resolution of the Bessel functions with this step-size is 0.075. The horizontal axis in this plot is the radius r -axis. Note in Table I that in every case (row) the inherently dimensionless Bessel function argument, $x = \alpha r$, thus demonstrating the scale factor utility of α . (e.g., $2.4048 = 0.075 \times 32$.)

Table 1: IMPORTANT VALUES FOR RADIAL MAGNETIC COMPONENTS

Radius Values $r = x/\alpha$	Zeros of $J_0(x)$ X	Zeros of $J_1(x)$ x	Description
0		0	B_z pos max, B_θ zero
32	2.4048		B_z zero, B_θ pos max
51		3.8317	B_z neg max, B_θ zero
74	5.5201		B_z zero, B_θ neg max
94		7.0156	B_z pos max, B_θ zero
116	8.6537		B_z zero, B_θ pos max
136		10.1735	B_z neg max, B_θ zero
158	11.7915		B_z zero, B_θ neg max
178		13.3237	B_z pos max, B_θ zero
199	14.9309		B_z zero, B_θ pos max

Since

$$\frac{\partial J_1}{\partial x} = J_0 - \frac{1}{x}J_1, \quad (42)$$

(41) becomes,

$$\begin{aligned} b_{23} &= \alpha B_z(0) \left[J_0(\alpha r) - \frac{1}{\alpha r} J_1(\alpha r) + \frac{1}{\alpha r} J_1(\alpha r) \right] \\ &= \alpha B_z(0) J_0(\alpha r). \end{aligned} \quad (43)$$

Using the above expressions together with (23), (28), and (30), in (39) and omitting functions' arguments for clarity,

$$(\nabla \times \mathbf{B}) \times \mathbf{B} = \begin{vmatrix} \hat{r} & \hat{\theta} & \hat{z} \\ 0 & \alpha B_0 J_1 & \alpha B_0 J_0 \\ 0 & B_0 J_1 & B_0 J_0 \end{vmatrix} = \mathbf{0}. \quad (44)$$

Figure 14 - graphical representation and tables, as well as Matrix derivation²¹⁰ (44); credit: D Scott

²¹⁰ Note: cylindrical notation and coordinates (not cartesian).

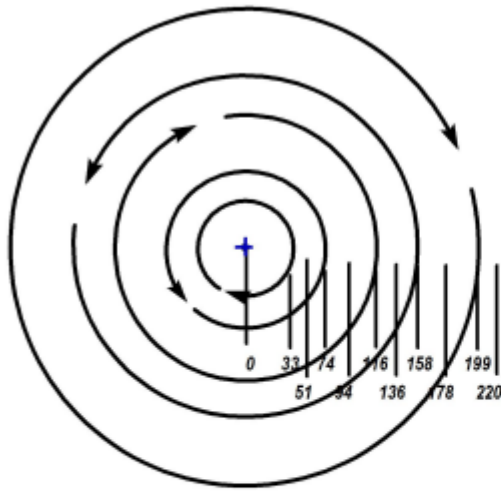

Fig. 3: Cross-section of a force-free current. In this view the reader is looking in the $+z$ -direction, in the direction of main current flow. The radius values shown are plotted as values of $r = x/\alpha$ ($\alpha = 0.075$), which were used in the Euler iterative solution of (36) and (37). At the radius values shown, the axial \mathbf{B} -field is zero-valued so the total field is only azimuthal (either clockwise or counter-clockwise circles).

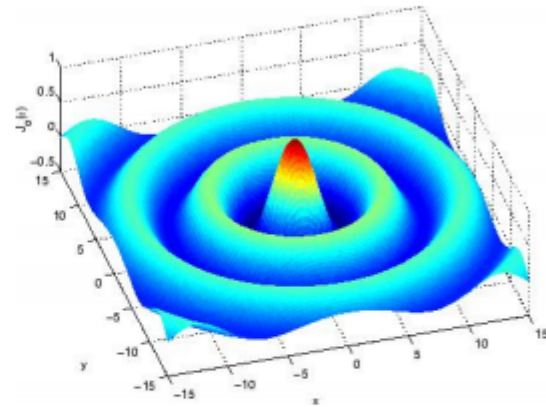

Fig. 4: Three-dimensional plot of the magnitude of the axial magnetic field component $B_z(r)$ and the current density $j_z(r)$. This demonstrates the relative strength of both those central (on-axis) fields. The magnitude scale of the horizontal axes used in this Figure are both x , the dimensionless arguments of the Bessel $J_0(x)$ and $J_1(x)$ functions.

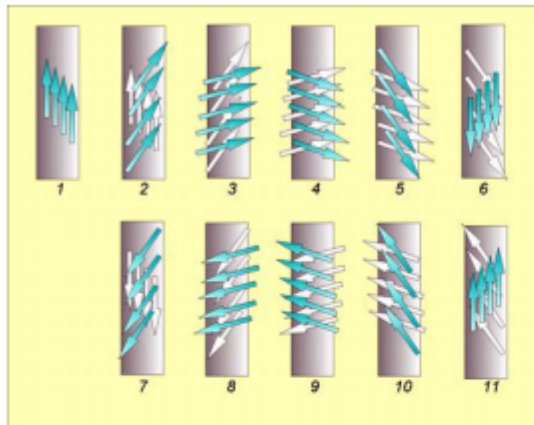

Fig. 5: The pitch angle of the helical total magnetic field, \mathbf{B} vector, that encircles a field-aligned current changes continuously with increasing radial distance from the central axis of the current. There are no abrupt quantum jumps or breaks in this angle's change or in the field's magnitude. One cycle (0° – 360°) of the pitch angle is shown. The cycle is sketched at eleven incrementally increasing sample values of radius. The shaded arrows show the total magnetic field direction at each value of radius, r , and the white arrows show the field direction at an increment just below each of those values of radius.

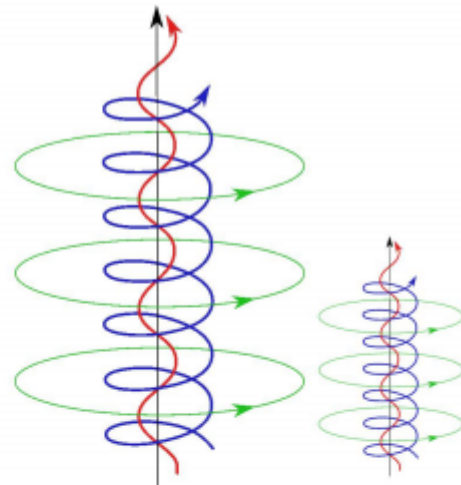

Fig. 6: Two different sized scale models of a FAC. These are both Lundquist-Alfvén-type images showing the helical structure of the collinear \mathbf{j} and \mathbf{B} vectors for small values of radius, r . (Left: Using $\alpha = \alpha_0$. Right: Using $\alpha = 2\alpha_0$.) This demonstrates why some investigators say that alpha controls the “tightness of twist”. It only appears to do that as a secondary effect because it's primary effect is as a scale factor on the overall dimensional *size* (r, z) of the model's structure.

Credit: Donald Scott; Force-Free Aligned Models, Progress in Physics, 2015

Figure 15 - Counter-rotating cylinders; Credit: D Scott

In the next subsection, we shall see that not only was Scott correct about what had previously been found, regarding the **650,000** amps (!!) but was able to predict the shape and rotation very well.

Table 6 - Efficiency Calculations²¹¹

r (distance)	Electric field	Magnetism	Electricity	Birkeland Current	BC vs EF %	BC vs Mag %	BC vs Elec %
0.01	1000000	10000	100	10	0.001	0.1	10
0.1	1000	100	10	3.16227766	0.316227766	3.16227766	31.6227766
1	1	1	1	1	100	100	100
2	0.125	0.25	0.5	0.7071067812	565.6854249	282.8427125	141.4213562
3	0.037037037	0.1111111111	0.3333333333	0.5773502692	1558.845727	519.6152423	173.2050808
4	0.015625	0.0625	0.25	0.5	3200	800	200
5	0.008	0.04	0.2	0.4472135955	5590.169944	1118.033989	223.6067977
6	0.004629629	0.0277777777	0.1666666666	0.4082482905	8818.163074	1469.693846	244.9489743
7	0.002915451	0.020408163	0.142857142	0.377964473	12964.18142	1852.025918	264.5751311
8	0.001953125	0.015625	0.125	0.3535533906	18101.9336	2262.7417	282.8427125
9	0.001371742	0.012345679	0.1111111111	0.3333333333	24300	2700	300
10	0.001	0.01	0.1	0.316227766	31622.7766	3162.27766	316.227766

Electric field, Magnetism, Electricity and Birkeland Current

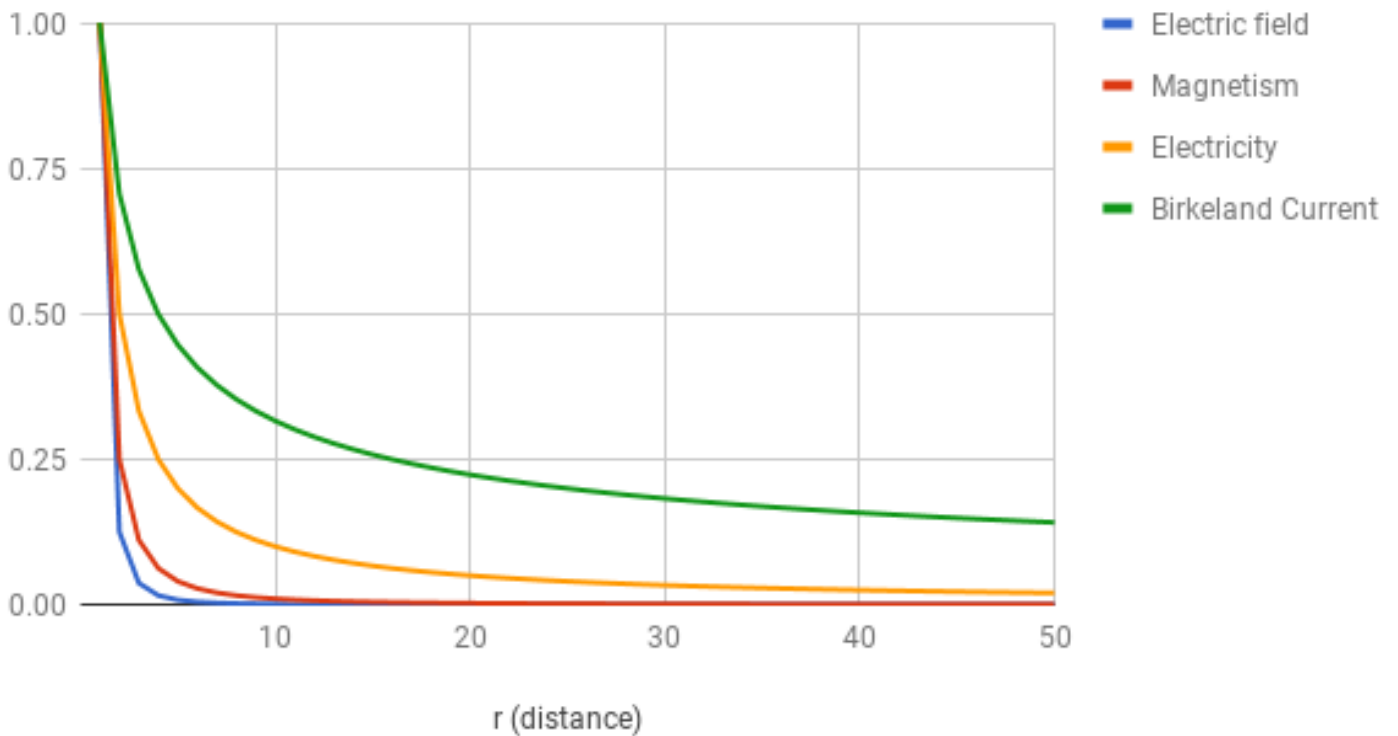

Figure 16 - Various efficiencies of electromagnetism

²¹¹ https://docs.google.com/spreadsheets/d/1SH5lsxmTlcltIS7hnnwgtXRzq2p05F1NfcSFwYOTd_w/edit?usp=sharing

Electric field, Magnetism, Electricity and Birkeland Current (log)

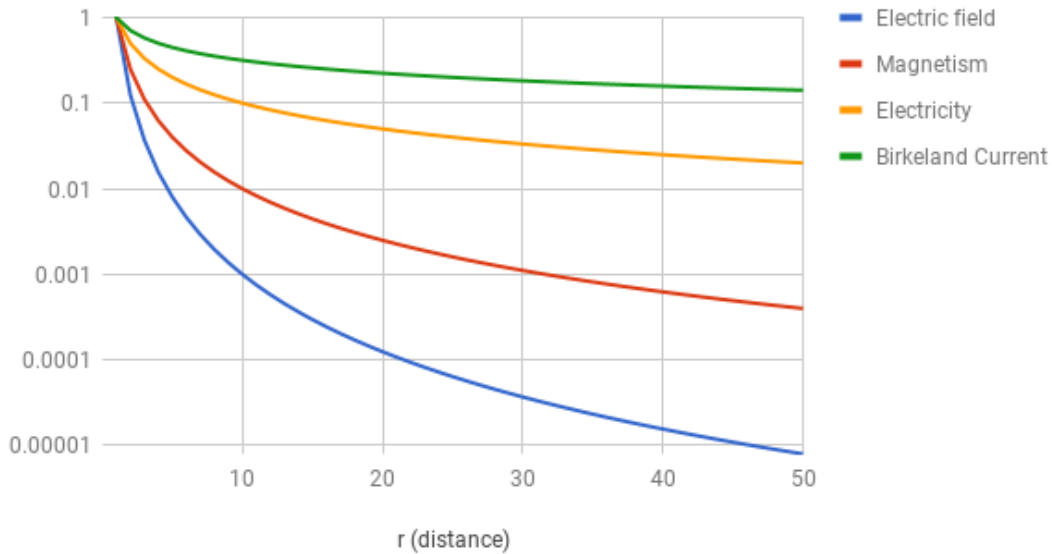

Figure 17 - in log scale (for orders of magnitude)

Birkeland Current Efficiency

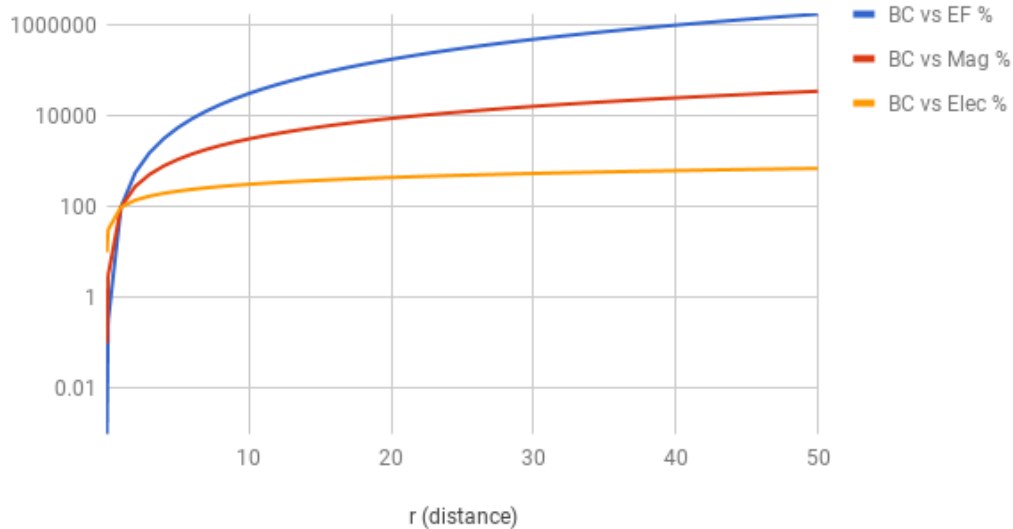

Figure 18 - Efficiency of E, B, and electricity (in wire) vs. Birkeland Currents, log scale

Clearly, beyond a short propagation distance, electromagnetism simply will not conduct without enormous voltage tension (such as in lightning). However, it is now known by NASA/ESA that electricity is regularly flowing (not in arc mode) from Saturn to Enceladus²¹², Jupiter²¹³ to Io²¹⁴, and the Sun to those planets²¹⁵ and to Earth²¹⁶. This is not disputed²¹⁷. For more information, see PEMS²¹⁸.

²¹² https://www.nasa.gov/multimedia/imagegallery/image_feature_2069.html

²¹³ <https://www.newscientist.com/article/mg13318093-400-science-the-billion-amp-current-that-flows-round-jupiter/>

²¹⁴ <https://www-spod.gsfc.nasa.gov/Education/wio.html>

²¹⁵ <https://www.nature.com/articles/nature03333>

²¹⁶ <https://www.scientificamerican.com/article/sun-spots-and-climate-change/>

²¹⁷ <https://eos.org/research-spotlights/where-are-the-electrical-currents-in-the-enceladus-plume>

Mainstream Discovers Birkeland Currents as Coaxial “Astrophysical Jets”

In the 1990’s the first satellite data began to return information about electricity in space. By the 2000’s it became obvious that probes needed to measure magnetism. Unfortunately, many of the early probes in this “new era” were not designed to also measure electric currents via plasma, and missed the presence of electrical currents. Sometimes it was a matter of shielding via dust. However, as more probes began to enter interesting systems, and the use of radio telescopes increased, the presence of galactic astrophysical jets and flux magnetic ropes (frozen in fields), began to emerge **as if without a root** in already established plasma electromagnetic cosmology. Thankfully, the IEEE has been the one institution that has enabled electrical engineers and dissenting scientists to voice their doubts as to the gravitic nature of cosmology, at least without electromagnetism^{219 220 221}. The belief that electromagnetism would hold no effect was supported by using the $1/r^2$ argument, despite the fact that **gravity is held by this same inverse square law**.

Electrostatics	Gravity
Force: $F_e = \frac{kq_1q_2}{r^2}$	Force: $F_g = \frac{Gm_1m_2}{r^2}$
Field Strength: $E = \frac{F_e}{q}$	Field Strength: $g = \frac{F_g}{m}$
Field Strength: $E = \frac{kq}{r^2}$	Field Strength: $g = \frac{Gm}{r^2}$
Electrostatic Constant: $k = 8.99 * 10^9 \frac{N \cdot m^2}{C^2}$	Gravitational Constant: $G = 6.67 * 10^{-11} \frac{N \cdot m^2}{kg^2}$
Charge Units: Coulombs	Mass Units: kilograms

Figure 19 - Side by side comparison of Electrostatics and Gravity²²²

This blind devotion merely goes back to the era of Lord Kelvin and the widespread misconception (debunked by Kristian Birkeland²²³) that charge cannot be separated in space²²⁴. Somehow this mechanistic appraisal of the “empty” vacuum of space has managed to be taught to this day. However, it is now known that plasma is 98-99% of observable matter in space²²⁵, and it fills the region of space in between stars and planets. It has certainly been shown recently that the ionosphere surrounding Earth is highly charged *and* roiling with magnetic behaviors and electric currents²²⁶.

²¹⁸ [4]

²¹⁹ <https://ieeexplore.ieee.org/document/45495/>

²²⁰ <https://ieeexplore.ieee.org/document/4316614/>

²²¹ <https://ieeexplore.ieee.org/document/1265349/>

²²² Not shown: EMF is 10^{39} x stronger than gravity, all units being equalized in a Newtonian framework.

²²³ https://pwg.gsfc.nasa.gov/polar/EPO/auroral_poster/aurora_all.pdf

²²⁴ https://en.wikiquote.org/wiki/Nikola_Tesla

²²⁵ <https://thehappyscientist.com/content/teach-it-right-first-time>

²²⁶ <https://www.nasa.gov/feature/goddard/2018/nasa-spacecraft-discovers-new-magnetic-process-in-turbulent-space>

All of this is now ending, as Dark Matter (Λ CDM, WIMPs, MACHOs, etc...) continues to fail and PEMC and MOND rise to the surface as top contenders in a complete astrophysical cosmological framework for forces, energy, fields, and particle motion.

Gabuzda et al.: Jets of AGNs as Giant Coaxial Cables

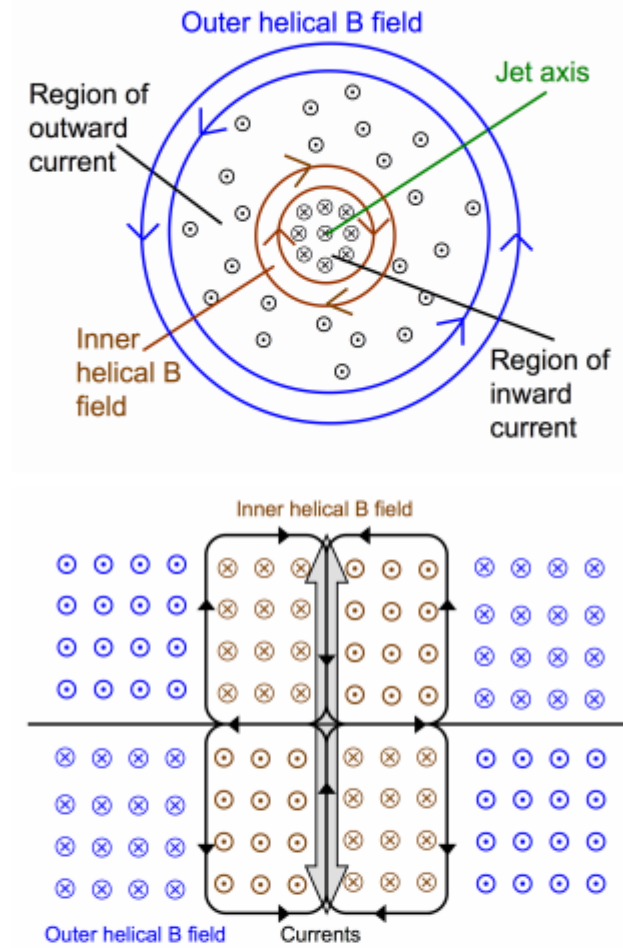

Fig. 2. Schematics of the system of **B** fields and currents suggested by the collected data on transverse Faraday rotation gradients, as viewed from above (i.e., looking down the jet) (upper) and from the side (lower). The region of inner helical field is shown in brown, the region of outer helical field in blue, and the currents in black. The partially transparent gray arrows in the lower panel represent the jet outflow. A circled dot represents current or field oriented out of the page and a circled X current or field oriented into the page.

Figure 20 - ESO's "coaxial jets"; credit: Gabuzda et al.²²⁷

There are some key conclusions found in this paper, and others like it:

“Context. The currents carried by the jets of active galactic nuclei (AGNs) can be probed using maps of the Faraday rotation measure (RM), since a jet current will be accompanied by a toroidal magnetic field, which will give rise to a systematic change in the RM across the jet...”

“A theoretical picture of the basic nature of this core–jet structure was proposed by Blandford &

²²⁷ “The jets of AGN as giant coaxial cables,” Gabuzda, Nagle, and Roche, 2017 <https://arxiv.org/pdf/1712.08414.pdf>

Konigl (1979), in which the “core” observed with VLBI corresponds to the “photosphere” of the jet, where the optical depth is near unity, $\tau \approx 1$, and the jet material makes a transition from optically thick to optically thin. Although the orientation of the observed polarization angle rotates 90° to become parallel to the synchrotron B field in sufficiently optically thick regions...

“Statistically significant transverse RM gradients across the parsec-scale jets of an increasing number of AGNs have been reported in the literature over the past several years (Gabuzda et al. 2014, 2015b, 2017), and have been interpreted as reflecting the systematic change in the line-of-sight component of a toroidal or helical jet B field across the jets (a helical B field includes both toroidal and poloidal components; it is the toroidal component that gives rise to the transverse RM gradient). Basic physics leads to the conclusion that these jets carry currents, whose direction can be inferred from the direction of the toroidal B field component giving rise to the transverse RM gradients...

“In fact, as was proposed earlier (Contopoulos et al. 2009, Mahmud et al. 2013) these collected results are consistent with a B-field configuration forming a nested helical-field structure, with one region of helical field inside the other and with the two having oppositely directed toroidal components. The orientation of the inner toroidal component corresponds to inward currents along the jet, and that of the outer toroidal component to outward currents along the jet direction, as shown schematically in Fig. [20]. This forms a system of currents and fields similar to that of a co-axial cable, with inward current along the center of the cable and outward current in a more extended sheath. Both of the regions of helical field contribute to the overall observed Faraday rotation; the inner region of helical field makes the dominant contribution on parsec scales, while the outer region of helical field makes the dominant contribution beyond a few tens of parsec from the jet base...”²²⁸

One paper would not a complete story make. More and more papers are surfacing such as this one. Another classic example by Kronberg et al from the American Astronomical Society:

“ABSTRACT We present radio emission, polarization, and Faraday rotation maps of the radio jet of the galaxy 3C303. From these data we derive the magnetoplasma and electrodynamic parameters of this 50 kpc long jet. For one component of this jet we obtain for the first time a direct determination of a galactic-scale electric current ($\sim 3 \times 10^{18}$ A), and its direction—positive away from the active galactic nucleus. Our analysis strongly supports a model where the jet energy flow is mainly electromagnetic.”²²⁹

3 exa-amps (quintillion) is not a small number, and the fact that it is a very reliable measurement based on observation should set aside all doubts from the readership as to the scope and power of the GEC and SSC electrical currents.

Figure 21 - Current Sheets in relation to Earth

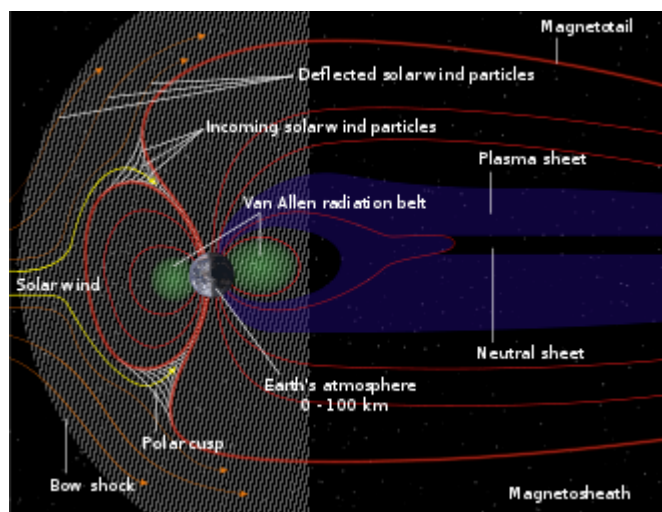

The following table demonstrates power scale:

²²⁸ Ibid.

²²⁹ “MEASUREMENT OF THE ELECTRIC CURRENT IN A kpc-SCALE JET,” Kronberg et al..., 2011, <http://iopscience.iop.org/article/10.1088/2041-8205/741/1/L15/pdf>

Table 7 Currents in Space scale

SGEC	MHD derived jets (theoretical) ²³⁰	$10^{18} + A$
GEC	jet galaxy 3C303 ²³¹	$3 \times 10^{18} A$
GEC	jet SGR A* ^{232 233}	1 THz X-rays
SSC	Solar Corona Currents ²³⁴	$10^{11} - 10^{12} A$
SSC	Solar Wind ^{235 236 237}	$10^{11} A$
SSC	Jupiter Ring currents/ Io Torus ²³⁸	$10^9 A$
SSC	Jupiter Auroral currents ²³⁹	650,000 A
SSC	Magnetic Tunnels to Earth ²⁴⁰	100,000 A
PEMS	Earth's Ring Current ^{241 242}	10 keV - 50 keV (100 keV)
PEMS	Van Allen/Heliosphere ^{243 244}	$3 \times 10^9 A$
PEMS	Blue Jets/Sprites ²⁴⁵	$10^{23} - 10^{24}$ photons or atoms
PEMS	Lightning ²⁴⁶	30k-500k A
HPG*	Powerline ²⁴⁷	40 A (avg)
CVS	Electricity in human heart ²⁴⁸	$< 1 \text{ mA} (1.87 \times 10^{-4} A)^{249}$
HEGEME	Electricity in a plant ²⁵⁰	$4.5 \times 10^{-8} A$
CNS	Nerve conduction ^{251 252}	4-6 nA

*Human Power Grid; Cardiovascular System; Central Nervous System

That one still finds citations, forums, and posts online to the effect of “there are no electric currents in space,” or worse, “there can be no electricity in space,” is mind boggling. Recently, for example, the Musca

²³⁰ <http://adsabs.harvard.edu/abs/1990ApJ...348...61J>

²³¹ <https://www.newscientist.com/article/mg21028174.900-universes-highest-electric-current-found/>

²³² <https://phys.org/news/2017-12-cosmic-filament-probes-galaxy-giant.html>

²³³ <https://arxiv.org/pdf/astro-ph/0102186.pdf>

²³⁴ <http://adsabs.harvard.edu/abs/1997A%26A...318..289K>

²³⁵ <http://adsabs.harvard.edu/abs/1967SoPh....1..220A>

²³⁶ <https://agupubs.onlinelibrary.wiley.com/doi/pdf/10.1029/2000JA900165>

²³⁷ <https://agupubs.onlinelibrary.wiley.com/doi/pdf/10.1029/JA080i034p04719>

²³⁸ <https://www.newscientist.com/article/mg13318093-400-science-the-billion-amp-current-that-flows-round-jupiter/>

²³⁹ http://www.igpp.ucla.edu/public/mkivelso/refs/PUBLICATIONS/Gerard%20lo_footprint-JCG.pdf

²⁴⁰ <https://www.space.com/6614-electricity-measured-space-tornadoes.html>

²⁴¹ <http://adsabs.harvard.edu/abs/1983SSRv...34..223W>

²⁴² <https://arxiv.org/pdf/0906.0429.pdf>

²⁴³ https://www.plasma-universe.com/Electric_currents_in_space_plasmas

²⁴⁴ <https://agupubs.onlinelibrary.wiley.com/doi/pdf/10.1029/JZ066i005p01321>

²⁴⁵ http://www.uas.alaska.edu/artssciences/naturalsciences/envs/faculty_staff/pubs/chapman.pdf

²⁴⁶ https://en.wikipedia.org/wiki/High_voltage

²⁴⁷ https://www.w8ji.com/power_line_voltage.htm

²⁴⁸ <http://circres.ahajournals.org/content/circresaha/33/1/39.full.pdf>

²⁴⁹ 50 mV / 268 ohm <http://circres.ahajournals.org/content/circresaha/9/6/1280.full.pdf>

²⁵⁰ <https://youtu.be/-MumeA4q-5Q>

²⁵¹ <https://pdfs.semanticscholar.org/bb00/967a365c81263abd9ac539f954131ae6f13c.pdf>

²⁵² <https://physoc.onlinelibrary.wiley.com/doi/pdf/10.1113/jphysiol.1952.sp004734>

Sheet was modeled (see Figure 21), and is not only explained by NASA as an electric current²⁵³ but belonging to a very unique but common enough studied class of celestial objects called “Current sheets”^{254 255}. They are even discussed in solar wind behavior.^{256 257 258} Some of the citations are below. More about this can be found on the EU Gateway²⁵⁹ and at SuspiciousObservers (B Davidson).²⁶⁰

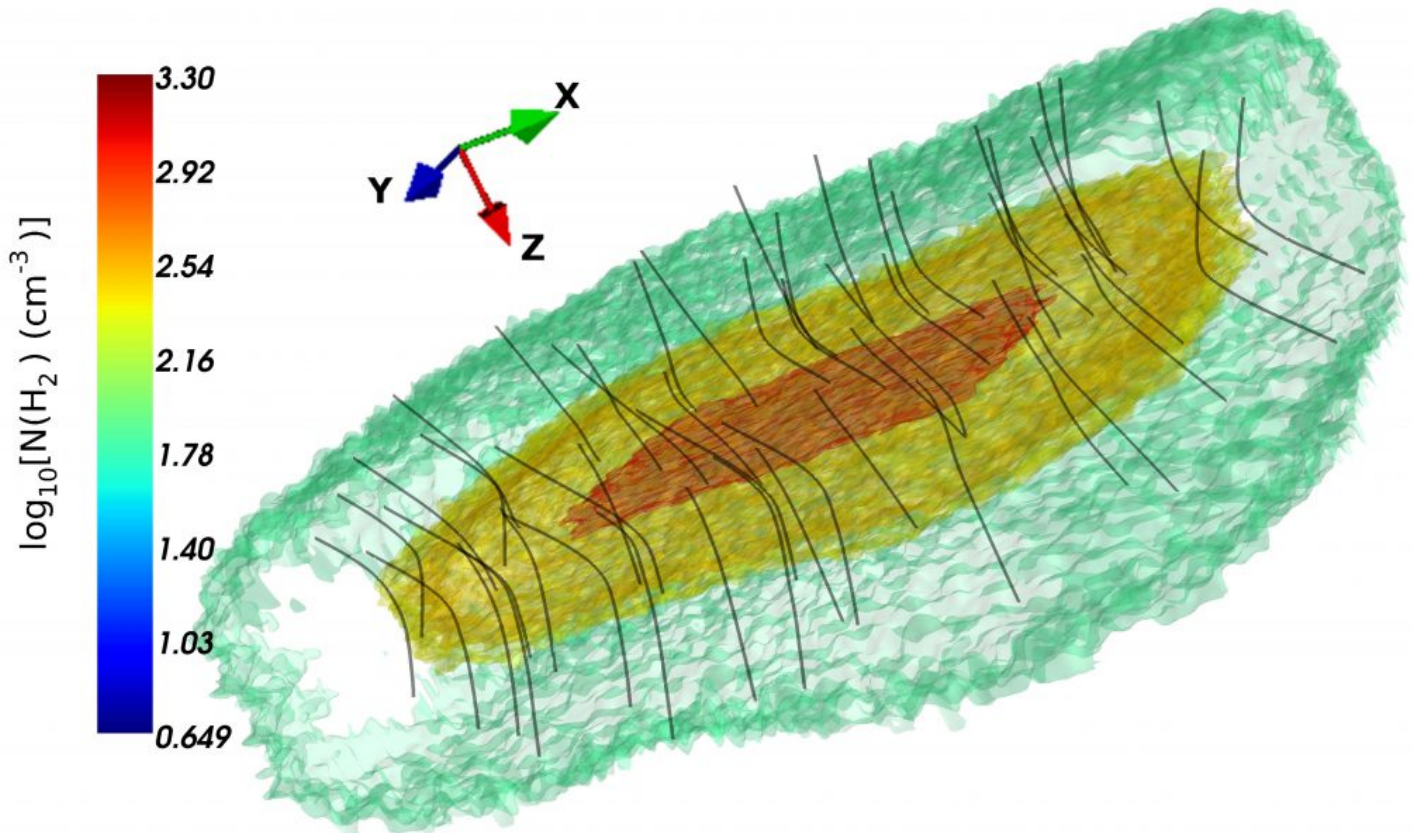

Figure 22 - Musca Current Sheet; credit: A. Tritsis, ANU²⁶¹

Robert Distinti’s “New ElectroMagnetism”

Although classical electromagnetism has been quite successful for mankind via Maxwell’s Laws²⁶² (Heaviside), they are not without some glitches²⁶³, including the Faraday Paradox^{264 265} and Inverse Source Problem.²⁶⁶

²⁵³ <https://phys.org/news/2012-08-thin-current-sheets-space-action.html>

²⁵⁴ <https://arxiv.org/ftp/arxiv/papers/1805/1805.03664.pdf>

²⁵⁵ <http://iopscience.iop.org/article/10.1086/303824/pdf>

²⁵⁶ https://drive.google.com/open?id=0ByRZ_FN_vit_SHNVVGZ5b2xoVWtqdFJM3FhTTh4UFdvNH4

²⁵⁷ https://drive.google.com/open?id=0ByRZ_FN_vit_b1pfb1FGRDZSV2czdWxLaWdoRjMyV3RmZURV

²⁵⁸

http://articles.adsabs.harvard.edu/cgi-bin/nph-iarticle_query?1988ApJ...326..418S&data_type=PDF_HIGH&whole_paper=YES&type=PRINTER&filetype=.pdf

²⁵⁹ <https://sites.google.com/site/electricuniversegateway/system/app/pages/search?scope=search-site&q=current+sheet>

²⁶⁰ <https://youtu.be/yexiK1baLYY>

²⁶¹ <http://en.protothema.gr/two-greek-scientists-map-3-d-structure-of-gas-clouds-video/>

²⁶² <http://science.sciencemag.org/content/349/6244/136/tab-e-letters>

²⁶³ <https://physics.stackexchange.com/questions/150493/problem-with-maxwells-theory>

²⁶⁴ https://en.wikipedia.org/wiki/Faraday_paradox

²⁶⁵ <https://physics.stackexchange.com/questions/146628/faradays-paradox>

²⁶⁶ <http://iopscience.iop.org/article/10.1088/0266-5611/22/3/018/meta>

As a response, in 2007 Distinti published his thesis, “Inductance Modeling Using New Electromagnetism,”²⁶⁷ in which he first produced a set of improved Maxwell equations,²⁶⁸ in order to perform his inductance modeling.

This paper is not meant to reproduce the entirety of this thesis. For brevity, the following tables and figures will demonstrate the improved model.

Table 8 - Page 21 of New Electromagnetism, Table 3-1 equations

Table 3-1: The New Electromagnetism Equations

The Force Equations	Name
$\mathbf{F} = \frac{K_E Q_S Q_T \hat{\mathbf{r}}}{ \mathbf{r} ^2}$	Coulomb’s Model (newtons)
$\mathbf{F} = \frac{K_M Q_S Q_T}{ \mathbf{r} ^2} [(\mathbf{v}_T \bullet \hat{\mathbf{r}})\mathbf{v}_S - (\mathbf{v}_S \bullet \hat{\mathbf{r}})\mathbf{v}_T - (\mathbf{v}_S \bullet \mathbf{v}_T)\hat{\mathbf{r}}]$	New Magnetism Model (newtons)
$\mathbf{F} = \frac{-K_M Q_S Q_T \mathbf{a}_S}{ \mathbf{r} }$	New Induction Model (newtons)

Where: $K_M = \frac{\mu}{4\pi}$, $K_E = \frac{1}{4\pi\epsilon}$. **Bold** letters represent vector quantities.

²⁶⁷ <http://www.distinti.com/docs/nethesis.pdf>

²⁶⁸ http://www.distinti.com/docs/poster_ne3_gr.pdf

The New Electromagnetism (NE) field models are developed by dividing the Force models by the target charge. This yields two types of force-per-coulomb fields as shown in the following table.

The Field Equations	Name
$\mathbf{E} = \frac{K_E Q_S \hat{\mathbf{r}}}{ \mathbf{r} ^2}$	Electric Field Model (Newtons/Coulomb)
$\mathbf{M} = \frac{K_M Q_S}{ \mathbf{r} ^2} [(\mathbf{v}_T \cdot \hat{\mathbf{r}})\mathbf{v}_S - (\mathbf{v}_S \cdot \hat{\mathbf{r}})\mathbf{v}_T - (\mathbf{v}_S \cdot \mathbf{v}_T)\hat{\mathbf{r}}]$	Magnetic Field Model (Newtons/Coulomb)
$\mathbf{M} = \frac{-K_M Q_S \mathbf{a}_S}{ \mathbf{r} }$	Inductive Field Model (Newtons/Coulomb)

In CE, a force-per-coulomb field is typically designated with an “E”; however, that would imply an electric field which is conservative. In NE there are two types of force-per-coulomb fields, the Electric field (**E**) and the Magnetic Field (**M**). **E** (Electric or Electro-Potential) fields are developed from Coulomb’s Model while **M** (Magnetic or Magneto-Kinetic) fields are developed from both New Induction and New Magnetism.

E fields convey potential energy and are conservative.

M fields convey kinetic energy and are not conservative.

The **M** field is NOT the **B**-field of classical theory since the **M**-Field truly is a “Force” field like the Coulomb field.

These equations have only been published for 11 years, and few attempts have been made to take them mainstream. What attempts have been made were met with biases and personal (professional?) resentment.²⁶⁹

New Magnetism

Of the two sets of equations, almost universally the most obvious and distinct change is in the transformation of **B** field to **M** field using vector mechanics. In both the “charge force” and “charge field” equations, a long additional vector term utilizing dot products is rendered. In most cases, these will cancel out or be reduced to where they disappear, yielding the original classic Gaussian equation. But when they do not,

²⁶⁹ <https://www.scienceforums.net/topic/93280-new-electromagnetism-an-improved-model-of-electromagnetism/>

the vector behavior and the so-called “edge currents”²⁷⁰ produced will explain away all sorts of behavior, such as Faraday’s paradox,^{271 272} and Wheeler’s paradox²⁷³.

Regarding New Magnetism,²⁷⁴ Distinti has been known to say that electricity might be capable of being reduced down to simply magnetism (as it produces these edge currents). However, there has not been a specific mathematical attempt at this as of yet.

New Gravity

Many individuals have postulated and sought for definitions of electrogravitics. Some may have even proposed a set of equations. However, Distinti has actually utilized the improvements he has made to electromagnetism, to derive the various relativity factors and demonstrate *why* Newton’s equation is as it is - as a derived formula, or special case. From the abstract for “New Gravity,”²⁷⁵

“This paper derives a hypothetical model for gravity based on the models of New Electromagnetism. With this electromagnetic model for gravity the following are derived:

- 1) Einstein’s time dilation factor $(1 - v^2/c^2)^{1/2}$ (page 15).*
- 2) The New Electromagnetic representation of matter (BMP) collapses when it travels faster than the speed of light (page 19).*
- 3) The Schwarzschild radius $r = (2K_G M)/C^2$ is derived from New Electromagnetism (page 20).*
- 4) The effect of gravity on time dilation (page 17).*
- 5) That the total energy of mass ($E = MC^2$) is constant to all observers in all reference frames (page 17).*

The derivations in this paper are based on a new mathematical abstraction for free space. This abstraction satisfies both the results of the Michelson-Morley experiment and is consistent with predictions of Relativity. This abstraction is essentially a new model for the old concept of the ether. This hypothetical abstraction provides a simple link between gravity and New Electromagnetism.”

Continuing in Introduction,

*“This paper shows that there may exist a model for the “Luminiferous Ether” that satisfies both the results of the Michelson-Morley experiment and the predictions of Relativity. The ether becomes the simplest method for unifying the models of electromagnetism with gravity. **The new model for ether shows that the force known as gravity may in fact be electromagnetic induction.***

The derivations in this paper make use of the Binary Mass Particles (BMP) described in the paper titled “New Electromagnetism” (ne.pdf). Whether or not the BMP represents an actual physical system is unknown at this writing; however, the binary models are mathematically sound and yield interesting results when applied to different situations.” [sic, emphasis added]

And finally,

“Inertia is represented as an electromagnetic phenomenon of massless charge particles.”

²⁷⁰ <http://www.distinti.com/docs/nm.pdf>

²⁷¹

<https://sites.google.com/site/electricuniversegateway/recent-news/pdx107paradox1a1b1cuncoveringthesecretsofmagnetism-distinti>

²⁷² <https://youtu.be/hNcR72HAuw0>

²⁷³ <https://www.youtube.com/watch?v=QReGWNp5fSs>

²⁷⁴ http://www.distinti.com/docs/the_secrets_of_qvxb.pdf

²⁷⁵ <http://www.distinti.com/docs/ng.pdf>



Figure 6-1

Again, we sum together all of the electromagnetic point charge equations and find the tangential velocity V_t required to keep the sum of the forces equal to zero.

$$1) \quad 0 = \frac{K_E Q_S Q_T \hat{r}}{|\mathbf{r}|^2} + \frac{K_M Q_S Q_T [(\mathbf{v}_T \cdot \hat{r})\mathbf{v}_S - (\mathbf{v}_S \cdot \hat{r})\mathbf{v}_T - (\mathbf{v}_S \cdot \mathbf{v}_T)\hat{r}]}{|\mathbf{r}|^2} - \frac{K_M Q_S Q_T \mathbf{a}_S}{|\mathbf{r}|}$$

Figure 23 - BMP Diagram; credit: R Distinti

Of course, the derivations would need to be proven out in lab. However the effect of unifying gravity and electromagnetism (and the weak force, vis a vis electroweak theory), is not to be underestimated. Before continuing, the author wishes to branch off on a small commentary on superconductivity.

The official definition of superconductivity is, “a phenomenon of exactly zero electrical resistance and expulsion of magnetic flux fields occurring in certain materials, called superconductors, when cooled below a characteristic critical temperature.”²⁷⁶

In experiments conducted on ‘high temperature’ Yttrium-Barium ceramics (YBCO), using liquid Nitrogen, the author demonstrated (Meissner effect) that the neodymium magnet begins its levitation during superconductivity by **rotating 90 degrees**.²⁷⁷ At such a time, when gravity becomes negligible, the magnetic field of the ceramic suddenly and forcibly repulses the magnet when the magnet is flat, as if the ceramic is magnetic itself. This demonstrates inherent internal currents. When the temperature threshold is exceeded again, however, the 90 degree position momentarily repulses instead of levitates. Finally, as warmth resumes there is no attraction or repulsion at all. To the author, this demonstrates quite readily that our understanding of the quantum electrodynamics and of gravitics is not complete.

As for the issue of the luminiferous ether,

“It was assumed (assumption #1) that this “stuff” exists in the space between electrons and protons like water between islands. It was also assumed (assumption #2) that this stuff was stationary with respect to the universe; therefore, as the Earth moves through the universe it passes through the ether. If this were so, then it is reasonable to conclude that an interferometer would enable us to measure the velocity of the Earth relative to the ether/universe.

After many measurements, at different times of day/year, the interferometer showed no indication that the velocity of light was different in either of the two interferometer arms (both of which were tangent to the surface of the Earth). Because the interferometer did not show any difference in the velocity of light, then the assumptions about the nature of the ether were incorrect. This incorrectly translated to the final conclusion that there is no ether.

²⁷⁶ Ibid. Wikipedia

²⁷⁷ <https://www.youtube.com/watch?v=ApR2Ttde9Aw>

Further suppose there were another relationship between the Earth and the ether that would also give a negative result to the Michelson-Morley Experiment. By extending the logic of Einstein's Principle of Equivalence such a relationship is revealed.

Einstein postulated that the effects felt by a person standing on the Earth were identical to the effects felt by a person accelerating through space at one times the acceleration of gravity. He called this the Principle of Equivalence....

Since the Michelson-Morley experiment was conducted tangent to the surface of the Earth, then the interferometer should read no ethereal movement. This suggests that the ether is spiraling toward the Earth (since the Earth is rotating).

If ether does exist and it is accelerating toward the Earth symmetrically in all directions, then where does it go? One possible answer is that it annihilates with the matter of the Earth, releasing energy. This release of energy may be part of the cause of radioactive decay and/or part of the explanation of why the core of the Earth is still molten. A following paper will discuss the behavior of the ether in more detail. This paper will treat the ether as a mathematical abstraction for the purpose of exploring the force known as gravity....

If gravity is caused by the earthward acceleration of ether, then how does accelerating ether interact with mass to generate the force? The answer is electromagnetic induction. Electromagnetic induction is responsible for Inertia (as shown in the paper titled "New Electromagnetism") and is shown here that it is also the mechanism of gravity....

If the ether is compressible then ether can not be of uniform density throughout the universe. This means that there may be regions where the ether is denser than here on Earth. These regions would necessarily conduct light faster than it does here on Earth.

A logical guess would propose that the density of ether increases toward the edges of the universe. Another logical guess would be that a black hole is a body so massive that it depletes ether faster than it can be replaced thereby causing a region so devoid of ether that light can not propagate at all. Logically then, the ether about the Earth is less dense near sea level than it is at the top of a mountain. This suggests that light travels faster at the top of a mountain than at sea level. This is consistent with Einstein's theories." [sic]

Although the author maintains that the presence or movement of a hypothetical ether is not strictly necessary, there are some interesting observations which happen to coincide as well with Eastern Sciences. Chiefly, that such an ether would be compressible. It would be interesting to draw a parallel for the reader to Tesla's interpretation of electricity as a form of incompressible fluid. When tension or pressure was applied on one side of the planet, Tesla maintained that it would translate immediately towards the other side of the Earth.

So what could this compressible at high velocity and Solar System scale but incompressible on human scale substance be? The author maintains that it is merely **charge**, which is compressible via increased tension (pressure) into various formations, such as Birkeland current, quantum behaviors, lasers, and zeta pinches and yet remains primarily incompressible or limited in compression.

It may be, that there is an as-of-yet undiscovered charge particle, or a mathematically sound charge abstraction which operates on a 4th dimension, or more interestingly a form of charge matrix which operates at all times in the background. Such a charge matrix would constitute not only a unified ether, but also could behave as an inductive *ocean*.

The remainder of the paper makes some New Electromagnetism reductions, and calculations, and refers to the next paper, Ethereal Mechanics in order to continue the discussion of a whirlpool like flow of the Ether into the Earth's poles. See Figures 24 and 25.

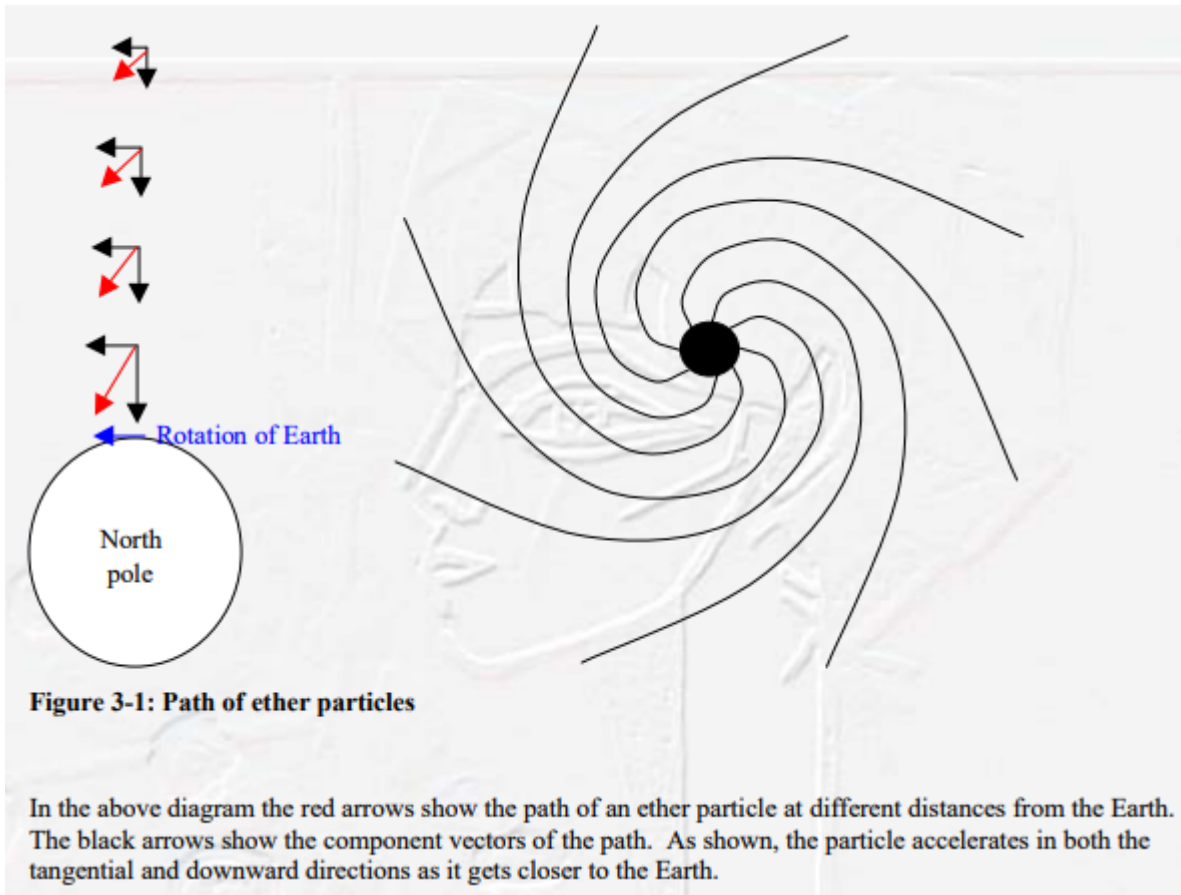

Figure 24 - Flow of proposed BMP ether²⁷⁸; credit: R Distinti

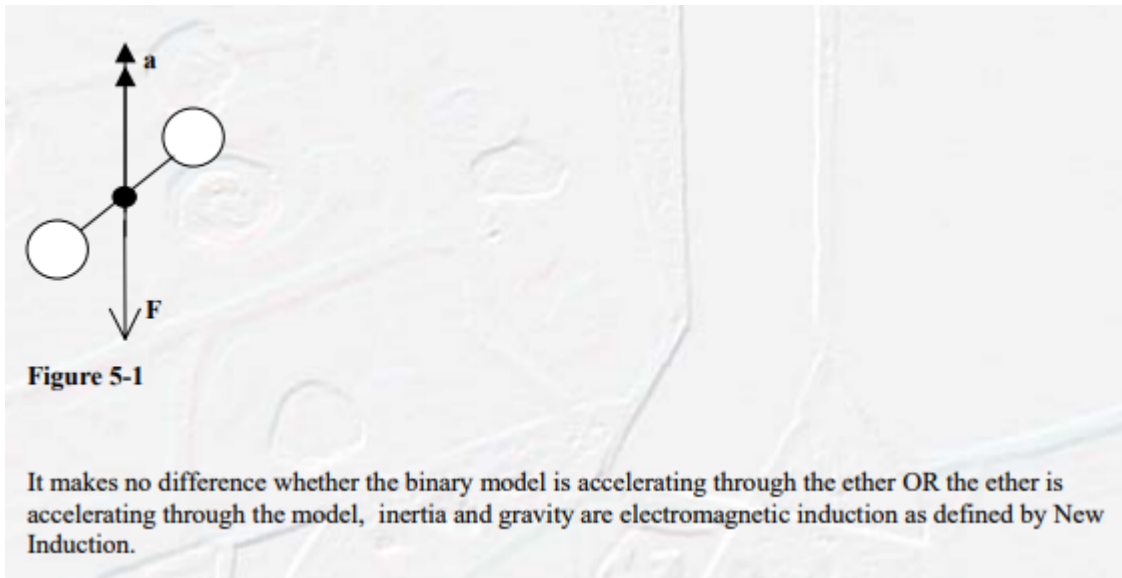

Figure 25 - force mechanics on BMP ether; credit: R Distinti

What the author wishes to illuminate is that **this is precisely the conditions postulated** in Birkeland currents (of which Distinti was unaware at the time of his publication²⁷⁹) and supported in magneto-

²⁷⁸ Ibid.

²⁷⁹ The author knows this, as it was the author who informed him of them in April 2018.

hydrodynamic models, and *modern* black hole physics. Only instead of ether, as stated before, EMF is its own medium. This is all related to the effect previously discussed, of Marklund Convection.

New Magnetism

The work known as New Magnetism is a free book provided online for all²⁸⁰. What is of prime interest in this paper is the following topics:

1. Spherical magnetic model²⁸¹ (as opposed to toroidal (Gaussian) or double-bell (LaPointeian))
2. The Binary Mass Particle
3. The Edge Current
4. The “Corner Effect”
5. Faraday’s Riddle/Paradox
6. Relativistic Beams

Spherical Magnetism

In this paper, various models of magnetism are proposed. This, however, is probably the simplest. It will be met with some natural skepticism, however, as the typical toroidal field shape is culturally familiar through iron filings experiments conducted in primary and secondary education levels. Nevertheless, it must be mentioned.

Table 4-1: Forms of New Magnetism

Point Charge Form	$\mathbf{F} = \frac{K_M Q_S Q_T}{ \mathbf{r} ^2} [(\mathbf{v}_T \bullet \hat{\mathbf{r}})\mathbf{v}_S - (\mathbf{v}_S \bullet \hat{\mathbf{r}})\mathbf{v}_T - (\mathbf{v}_S \bullet \mathbf{v}_T)\hat{\mathbf{r}}]$	Note: $K_M = \frac{\mu}{4\pi}$
Wire Fragment Form	$d^2V_K = \frac{-K_M I_S}{r^2} \left[\left(\frac{I_S}{Q_S} (d\mathbf{L}_S \bullet \hat{\mathbf{r}}) + (\mathbf{v}_{FS} \bullet \hat{\mathbf{r}}) - (\mathbf{v}_{FT} \bullet \hat{\mathbf{r}}) \right) (d\mathbf{L}_S \bullet d\mathbf{L}_T) \right. \\ \left. + (d\mathbf{L}_S \bullet \hat{\mathbf{r}})(\mathbf{v}_{FS} \bullet d\mathbf{L}_T) + (d\mathbf{L}_T \bullet \hat{\mathbf{r}})(\mathbf{v}_{FT} \bullet d\mathbf{L}_S) \right]$	
Wire Form	$V_K = -K_M I_S \oint_S \oint_T \frac{1}{ \mathbf{r} ^2} \left[((\mathbf{v}_{FS} - \mathbf{v}_{FT}) \bullet \hat{\mathbf{r}})(d\mathbf{L}_S \bullet d\mathbf{L}_T) \right. \\ \left. + (d\mathbf{L}_S \bullet \hat{\mathbf{r}})(\mathbf{v}_{FS} \bullet d\mathbf{L}_T) \right. \\ \left. + (d\mathbf{L}_T \bullet \hat{\mathbf{r}})(\mathbf{v}_{FT} \bullet d\mathbf{L}_S) \right]$ The above equation is the kinetic voltage generated in a target loop and is for closed loop systems only. For uniform current distribution.	

Figure 26 - New Magnetism; credit: R Distinti²⁸²

One of his claims for this is the fact that in Coulomb’s Model, the denominator is $4\pi r^2$ which indicates a spherical relationship. He claims also that Biot-Savart does not reflect this and that antenna propagation²⁸³ does not reflect a toroidal behavior, and therefore magnetism must be spherical. This might be a bit of a logic leap, but it is intuitively and practicably true. Perhaps the torus is the special case, or a case of interference or dampening. So, for example, the bar magnet cancels out centrally as the poles begin to conflate one another.

²⁸⁰ <http://www.distinti.com/docs/nm.pdf>

²⁸¹ Spherical modeling reconciles NEM derivation of relativistic gravity with Relativity Theory.

²⁸² Ibid.

²⁸³ Robert Distinti’s personal field of expertise is antenna engineering.

To start this process we write the equation that defines the BMP (using V1 models):

$$1) 0 = + \frac{K_E Q_S Q_T \hat{\mathbf{r}}}{|2\mathbf{r}|^2} - \frac{K_M Q_S Q_T ((\mathbf{v}_S \times \hat{\mathbf{r}}) \times \mathbf{v}_T)}{|2\mathbf{r}|^2} - \frac{K_M Q_S Q_T \mathbf{a}_S}{|2\mathbf{r}|}$$

The above simplifies to:

$$2) 0 = + \frac{C^2 \hat{\mathbf{r}}}{|2\mathbf{r}|} - \frac{((\mathbf{v}_S \times \hat{\mathbf{r}}) \times \mathbf{v}_T)}{|2\mathbf{r}|} - \frac{\mathbf{a}_S}{1}$$

Since the acceleration of the source is the centripetal acceleration due to the tangential velocity (V_t) of the source then:

$$3) 0 = + \frac{C^2 \hat{\mathbf{r}}}{|2\mathbf{r}|} - \frac{((\mathbf{v}_S \times \hat{\mathbf{r}}) \times \mathbf{v}_T)}{|2\mathbf{r}|} - \frac{V_t^2 \hat{\mathbf{r}}}{r} \text{ and}$$

$$4) 0 = C^2 \hat{\mathbf{r}} - ((\mathbf{v}_S \times \hat{\mathbf{r}}) \times \mathbf{v}_T) - 2V_t^2 \hat{\mathbf{r}}$$

The equation in step 4 is the essential equation for the BMP. Recalling from v1/ne.pdf; V_t is the tangential velocity of the charges that comprise the system such that $|\mathbf{v}_T| = |\mathbf{v}_S| = V_t$. V_t is measured relative to the system.

Figure 27 - Distinti derives the behaviors of the BMP; credit: R Distinti

Though he would later begin to use the term “pretons” for the BMP, the initial concept of the BMP is rather genius. Because everything is already describable in binary (dualistic) means, from electromagnetism itself to the wave-particle behavior of matter, this dual system does make some intuitive sense. However, one area it suffers in is detectability: where are these BMP/pretons? Furthermore, are we not coming up with additional portions of matter in order to circularly derive that which we already know? Although it may likely - more than likely - be that much of our models are special cases for more general versions, it cannot be that everything needs added terms and that every model needs an added half. Then again, the theory of anti-matter might disagree with this assessment. Is there really anything that can exist without its bipolar counterpart? Perhaps the BMP is the electron-anti-electron. Or perhaps the BMP is a magneton and anti-magneton. The problem is, when describing an ether, that this sort of issue goes round and round, without hardly getting anywhere definite.

In his book, the discussion of the BMP evolves into several diagrams of behavioral arrangements. However, this paper is not the place for discussion at length of the BMP or its arrangements. Rather, the author wishes to indicate that the mathematical enhancements offered by New Magnetism and New Electromagnetism do, as a whole, reduce the variability of theory into a simpler framework, which is an EPEMC ideal of applying Occam’s Razor. In order for a theory to be included into EPEMC, it must both *better* satisfy

what is observed in nature **and** be simpler. Spherical geometry is far simpler than toroidal, and also reflects antenna and IR radiation patterns. If solar winds and heat and light were know to radiate in a toroidal manner, this might be considered more natural and simple. Although several planets have toroidal magnetic fields, it may again be noted that these arrangements are due to complex internal dynamics in the core, and are probably only toroidal due to mutual interference. See Figure 28.

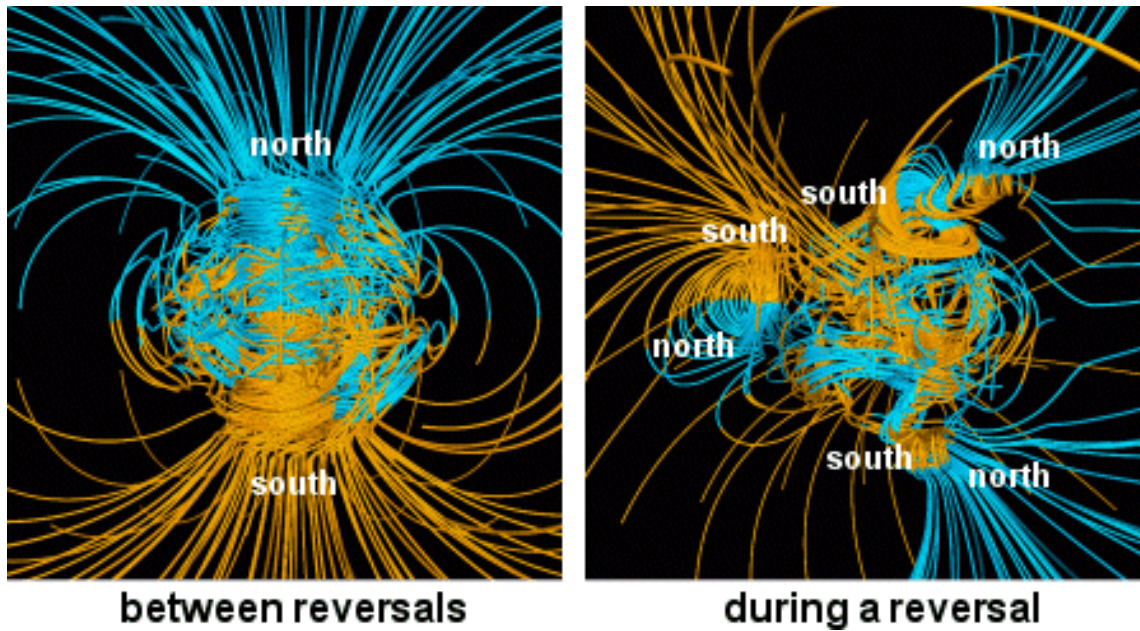

Figure 28 - Earth's Current magnetosphere (left) and during reversal being canceled out (right); credit: ESA

It may be noted, as said in the Conclusion of PEMS²⁸⁴ that the Chinese regarding Taiji (Yin+yang) as having the following properties:

1. Infinite divisibility (no real monopoles)
2. Mutual Generation
3. Mutual Consumption
4. Mutual Opposition
5. Mutual Regulation
6. Mutual Destruction - this is the property we are referring to.

²⁸⁴ [4]

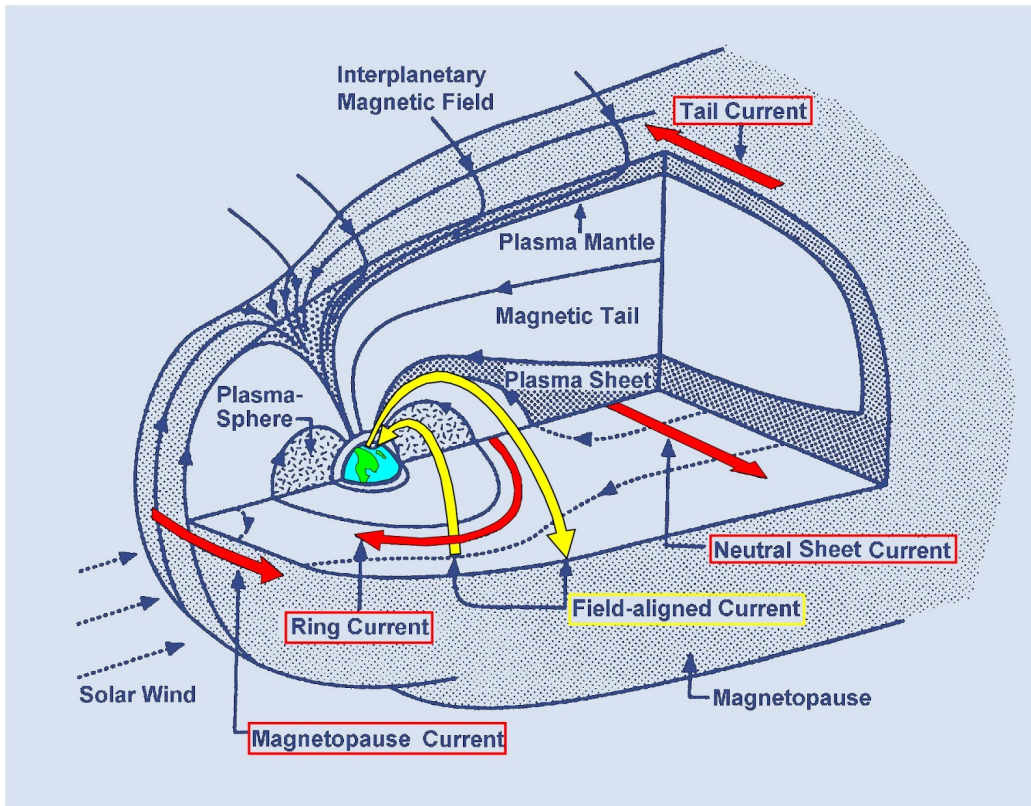

Figure 29 - Earth's Spherical Magnetopause interacting with Solar Wind, stretching it out; credit: geomag.us

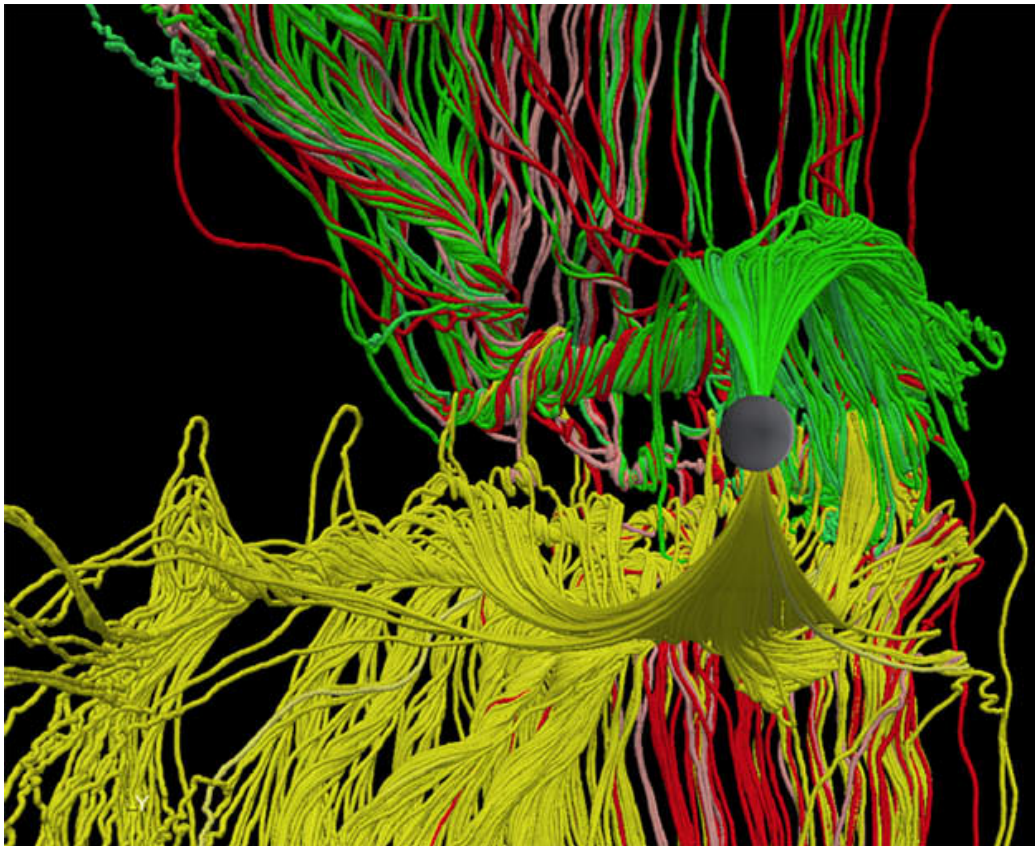

Figure 30 - BC's aka Magnetic Ropes²⁸⁵ feeding the Electrothermal Vine; credit: universetoday.com

²⁸⁵ It is important to recall that these ropes are concentric, counter-rotating circles that **spiral inward** as they approach maximum flux. They are carrying energy-mass *into* the EME (electromagnetic Earth).

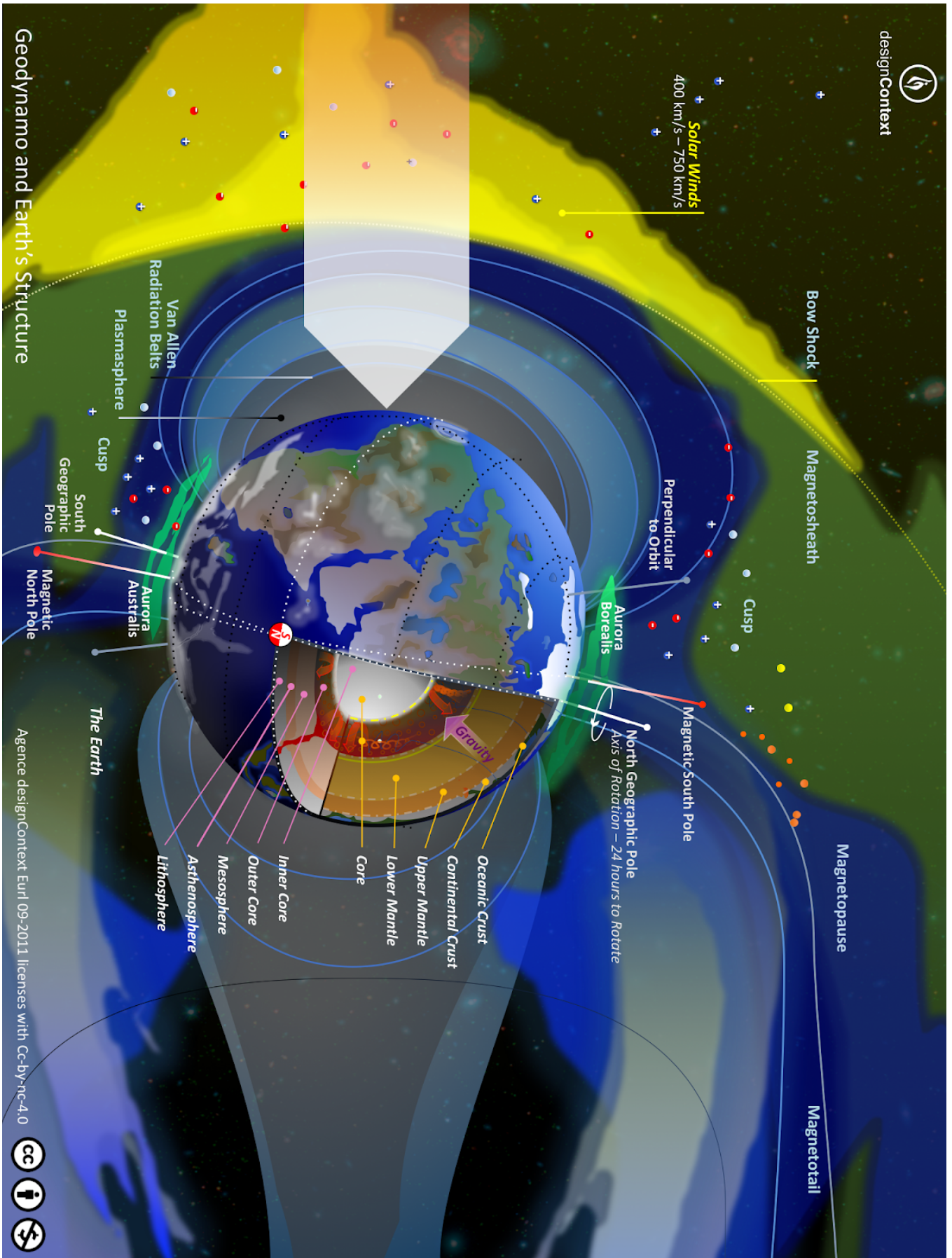

Figure 31 - The PEMS-HEGEME; credit: designContext.org²⁸⁶

²⁸⁶ Hi-res original: http://www.designcontext.org/wp-content/uploads/2017/08/Magnetosphere_9a.png

The Edge Current

A discussion of Distinti's ideas about Edge currents would not be complete without his comments on "Gaussian currents."²⁸⁷ (see Figure 32 for final derivation)

"A Gaussian current is a current not balanced by stationary charges. As such, a Gaussian surface constructed around the current will yield a non-zero result. An example of a Gaussian current is a charged sphere moving with velocity V. Another example of a Gaussian current is an electron beam. If the total number of charges (moving or stationary) of a system is in balance, the Gaussian of the system is zero. When the Gaussian of any fragment of a system is zero, that fragment will obey Galilean relativity as demonstrated in the previous section. Subsequently, the current of such a system is hereafter defined as a non-Gaussian current. The currents in permanent magnets, superconductors and good conductors (driven with small currents) are examples of non-Gaussian or low-Gaussian currents. The magnetic fields generated by such systems are hereby referred to as non-Gaussian or low-Gaussian magnetic fields... "To summarize, the motion of charges is always measured relative to the ether, regardless if the system is Gaussian or non-Gaussian. The benefit of a non-Gaussian system is that charges in the system are in balance; allowing the observer to calculate the magnetic field based on the motion of the charges relative to the system. Inversely, Gaussian systems allow one to measure ethereal properties such as velocity, density and acceleration." [sic]

The issue here, as far as the author can see, lies in calling space itself the medium, as, after all, the aether is the proposed medium. However, a good deal of practical experimental value is derived from this logic, as is shown in the Faraday Paradox experiment. Clearly, a moving magnet still has a magnetic field, as it must. However, is that "Absolute motion" relative to a [still] aether? It is not clear. However, from this concept emerges Distinti's particular genius in explaining paradox, such as magnetic braking that shouldn't even happen in classical electrodynamics.

As regards the existence of Edge Currents, Distinti writes,

"This chapter divulges a simplified model of permanent magnetism that enables us to solve some very interesting problems. This model uses Stokes' Theorem to provide a model for permanent magnets for which only the "Edge Currents" need to be considered. This technique is not new; it is described in Maxwell's book "A Treatise on Electricity and Magnetism" Volume 2 articles 423 and 492 which describe the interaction of magnetic "shells" (essentially flat magnets) as being analogous to current carrying loops."^{288 289}

So an Edge Current (EdC) is defined as the permanent magnetic behavior as if there were a loop of wire around the outer edges of the magnet (and presumably as concentric circles approaching the interior). It also implies that, taken to a limit, small loops of "current" can perform as a model of the magnet in its interior, as shown in Figure 33 and 34.

Distinti places some time on the visual proof (using MagnaView film) of these currents, before moving forward. For us, the most important factor is as it relates back to HEGEME and the interaction of a large

²⁸⁷ *ibid.*

²⁸⁸ *Ibid.* pg 55 on

²⁸⁹ "Note1: This simplified model is only for analysis of systems where the scale is much much larger than the distance between the magnetic molecules in the magnet. For quantum level analysis, the magnetic effects of each magnetic molecule must be considered individually." ~R Distinti

permanent magnet (of a sort) with the PEMS and the SSC at large. Essentially, we are interested in the movement of weather, and

$$19) \frac{V\ell}{R} = \left(\frac{VA\epsilon}{\ell} + \rho_F A \ell \right) v$$

Solving for v

Equation 5-2: Conduction Charge Velocity (approximate)

$$v = \frac{1}{AR \left(\frac{\epsilon}{\ell^2} + \frac{\rho_F}{V} \right)}$$

To find the Gaussian current we recall the modified Point-to-Fragment conversion identity of step 18:

$$20) I\ell = Qv$$

Substituting the conduction charge velocity equation (Equation 5-2) for v in step 20 and the excess charge equation (Equation 5-1) for Q; then solving for I yields

Equation 5-3: Gaussian Current

$$I_G = \frac{V}{R} \left(\frac{1}{1 + \frac{\rho_F \ell^2}{V\epsilon}} \right)$$

Equation 5-3 is the Gaussian component of charge flow in a wire. The equation is only the steady state value. The Gaussian component of charge motion can be further expanded by considering the effects of time varying currents.

Figure 32 - Gaussian Current derivation²⁹⁰; credit: R Distinti

other climatic effects; surface temperature of the Earth; and how strongly the solar wind (which can be more or less considered a constant current value of extremes above human survivability) interacts, thus affecting human life (and life in general). This aspect of the Electrothermal Vine is not to be underestimated in the growing period of Grand Solar Minimum or in the changes of our SSC position in the GEC.

Distinti goes on to spend considerable time demonstrating how and why EdC are important to consider when dealing with the interactions of magnets.

The interaction of magnets is of paramount interest. Whether it be the “magnetic ropes” that run parallel to the BC’s interacting with the Van Allen Belts and the Earth’s magnetosphere, or the interaction of the heliopause with the GEC itself, which we have recently punctured with the Voyager space probes²⁹¹ (and found

²⁹⁰ Ibid. Pg 42

²⁹¹ <https://www.space.com/22729-voyager-1-spacecraft-interstellar-space.html>

their locations to be far off course²⁹² due to false assumptions in the 1970s when they were launched); we are interested in *boundary conditions*.²⁹³ Why?

1. That's where life occurs (at the membranous shell).²⁹⁴
2. That's where energy moves in interesting, chaotic, and non-linear ways.²⁹⁵
3. That's where evolution occurs, as the Changes²⁹⁶ dictate some hitherto unspecified variables which force underlying changes in an "ether" (some fabric or matrix of reality whether or not there is a substance of aether must exist wherein mathematics and principles reside. Thus far mankind has not proven them to be equivalent places.)

A square flat permanent magnet, like the one shown in Figure 8-1, can be modeled as plane of electrons orbiting around parent atoms (The magnetic molecules).



Figure 8-1: Permanent Magnet

The electrons orbits can be thought of as very tiny circular currents. By observing Figure 8-1, one will notice that everywhere, except at the edges of the magnet, there are equal and opposite current motions. These equal and opposite current motions effectively cancel (for large scale systems) leaving just the current motion described in the following diagrams.

Figure 33 - Edge Current model proposed,²⁹⁷ credit: R Distinti

²⁹² https://www.youtube.com/watch?v=G_BxS_TErYQ

²⁹³ "a condition that is required to be satisfied at all or part of the boundary of a region in which a set of differential equations is to be solved."

²⁹⁴ [4]

²⁹⁵ Appendix B.V.4-6

²⁹⁶ Yi (易) - "Book of Changes"

²⁹⁷ Ibid. Pg 56-57

New Magnetism

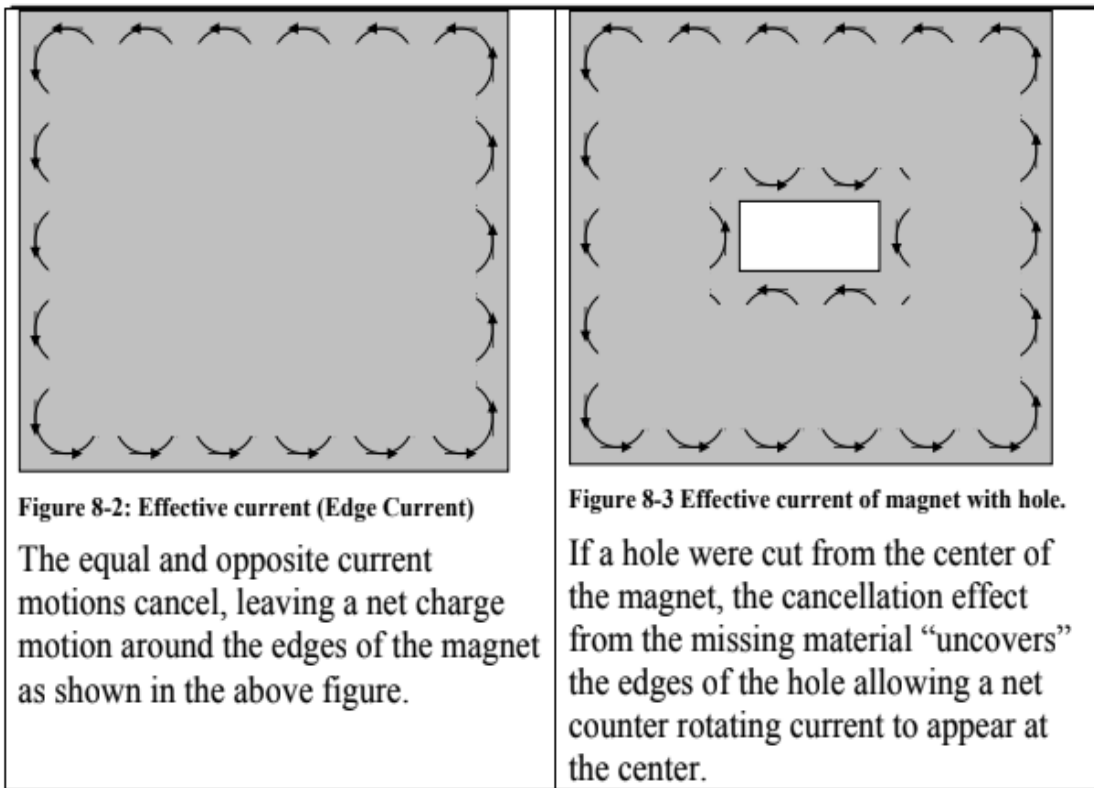

Figure 34 - Effective EdC; credit R Distinti

The “Corner Effect”

Moving back to discussion of the spheroidal vs. toroidal shape, Distinti says,

“In this proof, only magnetic field phenomena are of interest. The Electric field model of Coulomb, which is a spherical model, is unchanged from classical to New Electromagnetism, and is not a factor in this experiment/proof. The models of interest involve the fields of constant currents (magnetism) and time changing currents (induction). Both of which are magnetic field phenomena...”²⁹⁸

*“Consider a constant current in a rectangular loop; at the corners of the loop the current makes an abrupt 90 degree change in direction. This change in current should produce an inductive effect on a test charge placed nearby; however, this “corner effect” is not detectable by experiment (we have included a corner effect experiment as an appendix) nor is there mention of a corner effect found in our search of over 100 years of scientific literature. Since this corner effect has never been noticed, it either does not exist, or it is cancelled in some manner. The experiment analyzed using the classical toroidal (donut) shaped magnetic field predicts measurable kinetic voltages (emfs) at the corners; whereas, the **spherical magnetic field of New Electromagnetism (by both New Induction and New Magnetism) provides for complete cancellation of the “corner effect”.** [emphasis added]*

²⁹⁸ Ibid. Pag 75

It is not the job of this paper to support or prove the theories of one of the given names over another. However, there is a general “call to action” by the author for physics (in general) to test these cases and begin to evolve or enhance in areas of weakness.

One such area, for example, is the lack of a DC transformer despite no given reason it should not be possible. Distinti says of this, however, due to Corner Effect derivation²⁹⁹,

“The classical magnetic models provide for no effects other than the corner effect. Without other effects to cancel the corner effect, it should then be possible to construct a transformer that converts DC current into a DC voltage. An example of such a device (which does not work) is given in an appendix. This paper will derive the exact solutions for all magnetic effects acting upon the test charge (from both classical and New Electromagnetism). The results are then compared to show that New Electromagnetism predicts no effects on the target charge while classical models predict effects that we just do not see in reality.”³⁰⁰

After showing a square loop and doing some complex trigonometry, he finally derives,

$$17) M = K_M I_S V_S \sqrt{2} \left(\frac{1}{\sqrt{2P^2 + h^2}} \right) \mathbf{ax} \quad (\text{spherical inductance effect from far corner})$$

Figure 35 - Corner Effect inductance in New Magnetism;³⁰¹ credit: R Distinti

“The effect in step 17 goes to zero as P approaches infinity; therefore, there must be some other “cancellative” effect. A review of the New Magnetic model shows that it is only different from the classical model by the addition of the following term $(-v_s \cdot r^{\wedge})v_s$. This term gives the new magnetic model longitudinal effects that are not predicted by the classical Biot-Savart magnetic field model. This new term also shows that a magnetic field can affect a stationary charge. Finally, this new term provides the remaining cancellation of the corner effects required to bring magnetic field theory into compliance with observation.”[sic]

This is one of the few cases where the absence of proof is a strong indicator of proof of concept in that it casts doubt on the toroidal model of magnetism. While not outright disproving it, it does provide for a **more precise** model which can then be used for many practical purposes, including dealing with Faraday’s Paradox,

In subsequent chapters, he derives the “cancellative effect”, for more information see “New Magnetism.” See Figure 36 for final derivations.

He writes, in conclusion of these,

“...only a spherical magnetic field is capable of reconciling the corner effects produced by a conductive wire system containing a constant current. Although this proof only covers a single point on a square shaped loop, logic allows one to conclude that this “cancellative” effect holds true for all points around any shape of loop as long as the loop is closed.... Again, the spherical magnetic field model, proposed by New Induction and New Magnetism, predict no anomalous behavior with regard to

²⁹⁹ “The corner effect is caused by the change in direction of the current accelerating around the corner. The effects can be calculated by assuming a perfectly sharp corner and then substituting the impulse value into the calculation; however, some readers may find this engineering shortcut distasteful.” ~R Distinti, Pg 79

There are proposed experiments in Appendices A and B of his book.

³⁰⁰ Ibid. Pg 78

³⁰¹ Ibid. Pg 83

magnetic systems such as a wire loops. This is compared to the classical (transverse) model which seems to predict corner effects which have never been observed.³⁰² [sic]

New Magnetism

In this section all of the effects acting upon the target charge are collected and summed to find the total effect on the target.

For the Spherical field

For the spherical field theory of New Electromagnetism:

The near corner effect:

$$\text{From step 16) } \mathbf{M} = K_M I_S V_S \sqrt{2} \left(-\frac{1}{h} \right) \mathbf{ax}$$

The far corner effect:

$$\text{From step 17) } \mathbf{M} = K_M I_S V_S \sqrt{2} \left(\frac{1}{\sqrt{2P^2 + h^2}} \right) \mathbf{ax}$$

The effect of the left sides:

$$\text{From step 37) } \mathbf{M} = K_M I_S V_S \sqrt{2} \left[\frac{1}{h} - \frac{1}{\sqrt{P^2 + h^2}} \right] \mathbf{ax}$$

The effect of the right sides:

$$\text{From step 55) } \mathbf{M} = K_M I_S V_S \sqrt{2} \left[\frac{1}{\sqrt{P^2 + h^2}} - \frac{1}{\sqrt{2P^2 + h^2}} \right] \mathbf{ax}$$

It is not hard to see that the summation of the above 4 equations yields zero (0).

For the Transverse Field

For the Classical (transverse) field model, the effect on the target charge due to the corner effect is the result found in step 16) $emf = K_M I_S V_S \sqrt{2} \left(-\frac{1}{h} \right) \mathbf{ax}$.

Classical Electromagnetism provides no “cancelative” means to reconcile this effect with physical observation.

Figure 36 - Corner Effects of Electromagnetism;³⁰³ credit: R Distinti

Faraday's Paradox

“The Faraday paradox or Faraday's paradox is any experiment in which Michael Faraday's law of electromagnetic induction appears to predict an incorrect result. The paradoxes fall into two classes: Faraday's law appears to predict that there will be zero EMF but there is a non-zero EMF.”³⁰⁴

³⁰² Ibid. Conclusion, Pg 91-92

³⁰³ Ibid. Pg.91

³⁰⁴ https://en.wikipedia.org/wiki/Faraday_paradox

Writing of this, Distinti says,

“Faraday developed a generator consisting of a disk magnet coaxial to a conductive disk as shown in Figure 9-1. There are 4 modes of operation of the Homopolar Generator (HPG); the results of which comprise what is known as Faraday’s Final Riddle: Does a magnetic field move with the magnet. The generator is comprised of a disk magnet attached to a motor (A) placed next to a conducting copper disk attached to motor B. A stationary galvanometer is connected to the edge of the conductive disk and to the shaft of motor B with brush contacts. The Galvanometer enables the operator to detect the radial current generated in the disk (when power is being generated).

In the first mode of operation, both the disk and the magnet are stationary. Because there is no relative motion between the disk and the magnet, there is no power generated in the disk.

In the second mode of operation, the magnet is stationary and the disk is rotated by motor B. In this mode, the galvanometer detects power generated in the disk.

In the third mode of operation, the magnet is rotated by motor A and the disk is stationary. One might assume that since there is still relative motion between the magnet and the disk that there should be power generated; however, no power is detected.

In the fourth mode of operation, both the magnet and the disk are rotated together. Power is detected. One would think that because there is no relative motion between the disk and the magnet that no power should be detected. This seems to contradict Relativity.

One of the prediction made by Einstein based on his theory of Relativity is that the magnetic field must move with the magnet. If this were the case, then according to the Lorentz Force equation of classical electromagnetism, there should only be a current detected when there is relative motion between the disk and the magnet. This seems to be contradicted by the results of the experiment since there is power detected even when there is no relative motion between the magnet and the disk as shown in mode 4. This is also contradicted by mode 3 where there is relative motion but no power is generated.

New Magnetism resolves this by restating Einstein’s prediction. Instead of saying that a magnetic field moves with the magnet, we now say that a magnetic field moves with its source. In the case of a magnet, each charged particle is its own source of magnetic field energy. When the effect of each charge is considered separately, the proper operation of the Homopolar Generator is revealed without violating Einstein’s Relativity.”³⁰⁵ [sic]

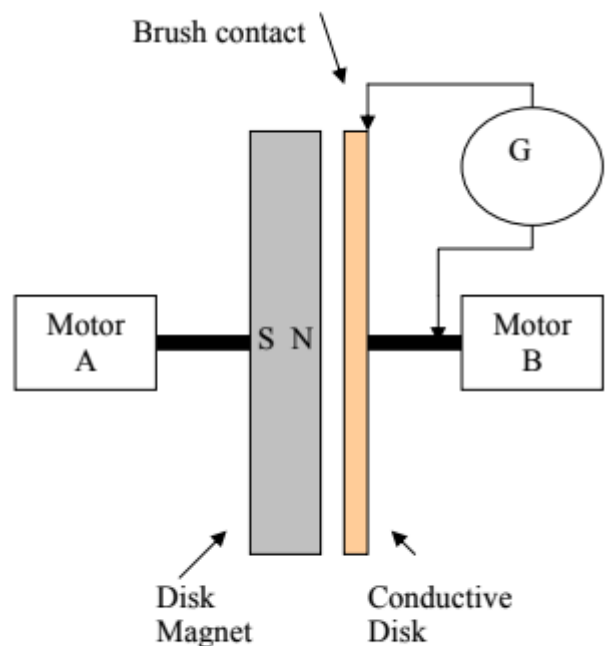

Figure 9-1: Faraday's homo-polar generator

Figure 37 - Homopolar Generator; credit: R Distinti

³⁰⁵ Ibid. Pg 68-69

$$\mathbf{F} = \frac{K_M Q_S Q_T}{|\mathbf{r}|^2} [-(\mathbf{v}_S \cdot \mathbf{v}_T) \hat{\mathbf{r}}]$$

Figure 38 - Distinti Force³⁰⁶ in New Magnetism³⁰⁷; credit: R Distinti

Distinti sets up an elaborate but elegant series of diagrams (figures 39, 40) of the rotating disc, and derives, at long last, the forces inherent in the disc.

New Magnetism

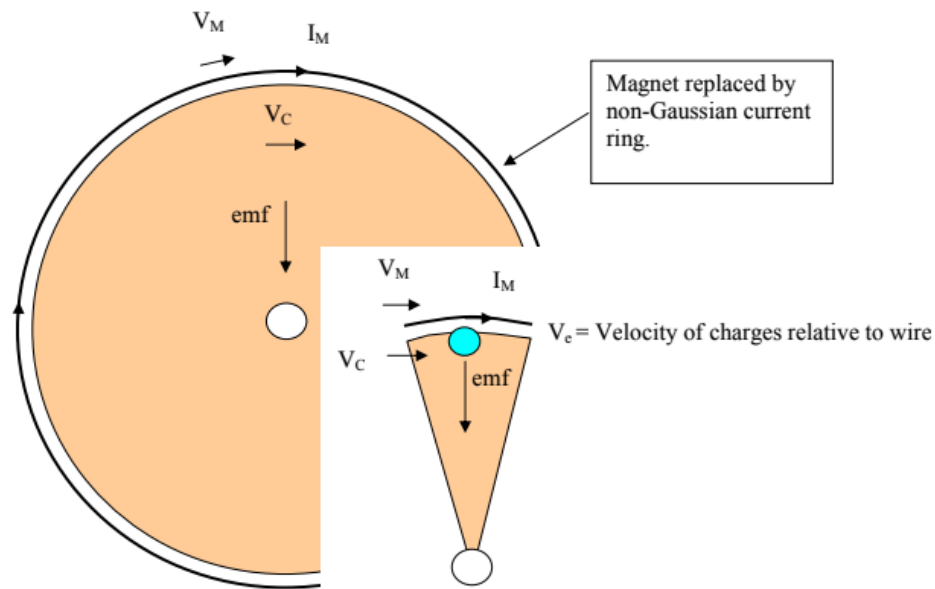

Figure 9-2

Figure 9-3

For simplicity consider only a small sector of the disc and a corresponding fragment of the "edge current" conductor as shown in Figure 9-3.

Figure 39 - Faraday Disc³⁰⁸; credit: R Distinti

³⁰⁶ The author has coined this term, as it is right for the corrected force equation to be renamed for the worker.

³⁰⁷ Ibid. Pg 71

³⁰⁸ Ibid. Pg.70 (compressed for space)

New Magnetism

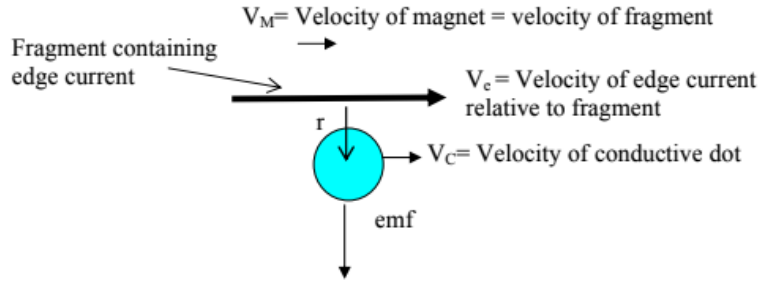

Figure 9-4: Essence of problem.

Since a Gaussian surface constructed around the magnet shows that there is no net charge in the magnet we can be sure that the edge current of the permanent magnet is non-Gaussian. Thus we write the charge motion equation for the edge current as a non-Gaussian current. Like the example in section 5.1 we assume that the traditional current in the fragment is comprised of Z charges moving with velocity V_e , relative to the wire. Thus, the total charge motion of the edge fragment, including stationary current is:

$$Q_M V_{QM} = (V_M)(-ZQe) + (V_e + V_M)(ZQe)$$

Figure 40 - EdC in Faraday Disc considered³⁰⁹; credit: R Distinti

Calculating the effect from the charges that comprise the traditional current on the positive charges in the blue dot first yields

$$6) F_{PI} = \frac{K_M Q_S Q_T}{|r|^2} [-(\mathbf{v}_S \cdot \mathbf{v}_T) \hat{r}] = -\frac{K_M YZQ_e^2}{|r|^2} (V_e V_C + V_M V_C) \hat{r}$$

Next calculating the effects of the stationary charges on the positive charges in the blue dot:

$$7) F_{PS} = \frac{K_M Q_S Q_T}{|r|^2} [-(\mathbf{v}_S \cdot \mathbf{v}_T) \hat{r}] = +\frac{K_M YZQ_e^2}{|r|^2} (V_M V_C) \hat{r}$$

Total charge force on positive charges in blue dot is:

$$8) F_{Ptotal} = F_{PI} + F_{PS} = -\frac{K_M YZQ_e^2}{|r|^2} (V_e V_C) \hat{r}$$

Note1: Notice that the velocity of the magnet cancels out.

Note2: Since the positive and negative charges in the disk have the same velocity, it is obvious that the force on the negative charges in the blue dot is the opposite of the above.

Figure 41 - Final Distinti Force derivation for Faraday Riddle³¹⁰; credit: R Distinti

³⁰⁹ Ibid. Pg. 71

³¹⁰ Ibid. Pg 72

New Magnetism

$$dV_k = -\frac{K_M Z Q_c}{|r|^2} (V_c V_c) dL$$

The above equation is the fragmentary emf. The entire emf along the radius of the sector (due only to the effects of the fragment) is found by performing an integration of this equation along a path from the edge of the disk to the hub.

It would not take much to write the equation that describes this entire system; however, the above equation shows us what we came to see. The above equation states that the velocity of the magnet has no effect on the emf detected in the disk. The emf in the disk is proportional to the strength of the magnet and the velocity of the disk; the rotational velocity of the magnet has no effect.

The above equation agrees with the observations made by Faraday.

The above explanation also satisfies Einstein since the magnetic field does move with the charges which are the source the magnetic field. One component of magnetic field is produced by the mobile carries and the other component from the stationary charges. These two magnetic field components produce equal and opposite effects thus canceling any added effect due to the motion of the magnet. This phenomenon is explained in more detail in chapter 5.1.

Note: this derivation only describes the no-load emf generated in a very small section of the disk. Under load, the disk will supply a non-zero current that results in effects (such as back-torques and eddy currents) which are not considered in this derivation. Although this book does not contain the complete models of the HPG; this book does contain the necessary models and techniques required to derive the general operation of any motor/generator.

Figure 42 - Fragmentary EMF³¹¹; credit: R Distinti

Relativistic Beams

Cosmic jets have been shown to be moving at a sufficient speed, and current (see Table 7), to be treated as relativistic currents³¹² using quantum electrodynamics.³¹³ As it happens, Distinti also has a (brief) treatment of these relativistic electron jets as single beams of electrons (not as Birkeland Currents):

“An electron beam is a line of like charges moving at velocity V. Since the charges repel each other due to Coulomb forces, there must be great electric potential along the beam that would force the charges to locations of lesser potential. The logical conclusion is that the charges would scatter in all directions, yet they don’t. According to classical teaching, this phenomenon is due to Time Dilation; however, New Electromagnetism clearly shows that Time Dilation is derived from electromagnetism. If Time Dilation is derived from electromagnetism then electromagnetism can not be affected by time dilation otherwise a recursive derivation would occur. This would be a paradox.”³¹⁴

³¹¹ Ibid. Pg 73

³¹² https://simple.wikipedia.org/wiki/Relativistic_jet

³¹³ https://www.nrao.edu/A2010/whitepapers/rac/Wehrle_AGN_jets_GCT.pdf

³¹⁴ Ibid. Pg 53

The simple answer is given to us by New Magnetism.

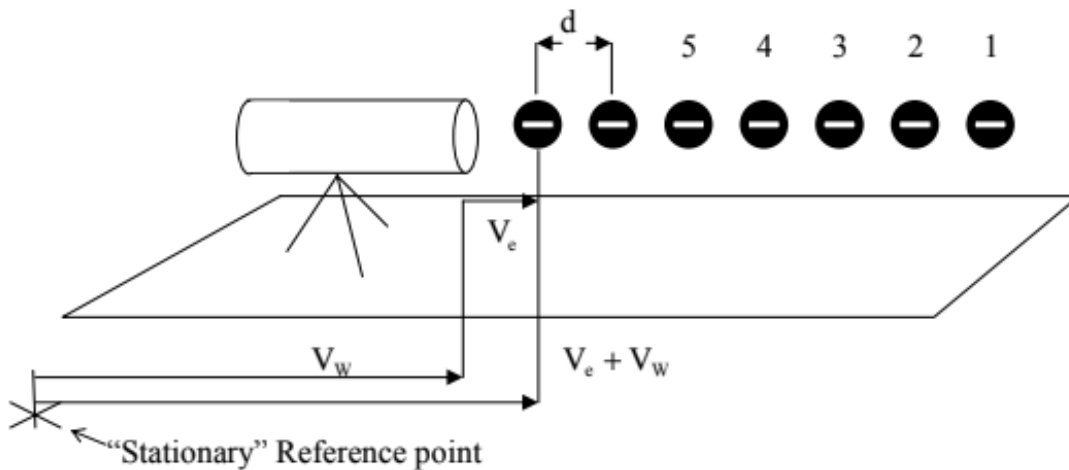

Figure 7-1

Figure 7-1 shows an electron gun emitting a constant beam of electrons. The velocity of the electrons with respect to the stationary reference point is $V=V_e+V_w$. The distance between electrons is d .

$$1) F_{23} = \frac{Q_2 Q_3}{d^2} (K_E - K_M V^2)$$

The above equation shows that as the velocity of the beam approaches the speed of light, the Coulomb forces are cancelled by the magnetic force; thereby allowing the beam to maintain coherency.

Figure 43 - Electron Beam Coherency of Relativistic jets³¹⁵; credit: R Distinti

In conclusion, New Magnetism and New Electromagnetism in general gives us a new set of tools which will undoubtedly be of importance as electromagnetism increases again in prominence in cosmology in general, and in the study of the PEMS-HEGEME.

Vortex Algebra ©

Although it is premature to release any major details of Robert Distinti's potentially *groundbreaking* work on vector-matrix algebra, it is worth mentioning here that Distinti has not been satisfied with Heaviside's treatment of vector algebra³¹⁶ (and any vector calculus thereby derived³¹⁷) as it makes use of the mathematical anomaly, i (the root of -1, which is undefined).^{318 319}

³¹⁵ Ibid. Pg 54

³¹⁶ <http://www.math.utah.edu/~gustafso/s2010/HeavisideCoverup2008.pdf>

³¹⁷ https://www.whitman.edu/mathematics/multivariable/multivariable_16_Vector_Calculus.pdf

³¹⁸ https://en.wikipedia.org/wiki/Imaginary_number

³¹⁹ https://en.wikipedia.org/wiki/Eigen_Vectors

His new set of Vortrix methods enable not only proper matrix division³²⁰ and full use of trigonometry and calculus in vectors and matrices of multiple dimensions, he is able to derive [-1] as a matrix that is multiplied (cross produced) with itself.

The image shows handwritten mathematical derivations on a light-colored background. The first equation is $i = \sqrt{[-1]} = \begin{bmatrix} 0 & -1 \\ 1 & 0 \end{bmatrix}$. Below it, the word "Consequently" is written. The second equation is $i^2 = \sqrt{[-1]}^2 = \begin{bmatrix} 0 & -1 \\ 1 & 0 \end{bmatrix} \begin{bmatrix} 0 & -1 \\ 1 & 0 \end{bmatrix} = \begin{bmatrix} -1 & 0 \\ 0 & -1 \end{bmatrix} = [-1]$. The third equation is $i^2 = [\hat{x} \times \hat{y}]^2 = \begin{bmatrix} 0 & -1 \\ 1 & 0 \end{bmatrix} \begin{bmatrix} 0 & -1 \\ 1 & 0 \end{bmatrix} = \begin{bmatrix} -1 & 0 \\ 0 & -1 \end{bmatrix} = [-1]$.

Figure 44 - Vortrix dealing of i with commutative properties³²¹; credit: R Distinti

Rather than use traditional commutation of complex vectors³²², he maintains that a cross product is not a orthogonal vector **but is an area instead** (or matrix). Intuitively, this makes more sense, as in fact length*width is a two dimensional area. Therefore a great deal of cheats and problems in Heaviside mathematics and electrical engineering become unnecessary (so long as longer calculations are willing to be computed). His first revisions of the paper are available³²³, but not published officially in any journals as of this writing. However, a series of videos detailing some of the derivations are available.^{324 325 326}

The author brings up the work of Vortrix Algebra as he believes the methods will be invaluable in calculating the real values of currents and impedances, as well as work and power in aforementioned current sheets. Or perhaps in the EdC of said current sheets or along plasma boundaries.

The Inappropriate Use of Terms

Before continuing further, the author wishes to insert a short comment about the growing inappropriate use of terms to either a) use recycled science without giving credit for *a priori* knowledge (previous research) or b) hide a lack of classical understanding.

It is not merely terming Birkeland Currents as "Magnetic Flux Ropes" which confuses the matter, but is after all utilitarian. It is an entire host of terms that really have completely different meaning, sometimes non-electromagnetic meaning:

³²⁰ <https://math.stackexchange.com/questions/228229/is-division-of-matrices-possible>

³²¹ "Vortrix Algebra © Robert Distinti, rev1.2", 2018, R Distinti, all rights reserved.

³²² $(a+bj)(c+dj) = (ac + bdj)$ in Heaviside, ignoring traditional (ancient) algebraic commutative properties.

https://en.wikipedia.org/wiki/Commutative_property

"The vector product (or cross product) of two vectors in three dimensions is anti-commutative; i.e., $b \times a = -(a \times b)$."

³²³ <https://www.patreon.com/file?h=18920557&i=2197295>

³²⁴ <https://www.patreon.com/EtherealMechanics/posts>

³²⁵ <https://www.youtube.com/watch?v=IlydKGu5eT4&t=1s>

³²⁶ <https://sites.google.com/site/electricuniversegateway/recent-news/vortrixalgebrardistinti>

1. Solar “Wind”³²⁷
2. Geomagnetic “Dynamo”³²⁸
3. Jets
4. Sprites, elves, etc...
5. Magnetic “tunnels”
6. Magnetic “portals”
7. “Gravitational” lens
8. Tidal lock
9. Magnetohydrodynamics³²⁹
10. Hydrogen Burning³³⁰
11. Quantum weirdness
12. Dirty Snowballs

The use of incorrect terminology as regards astronomy³³¹ has led us down a path of confusion and in some ways reveals a blatant attempt to distort the facts to continue supporting Newtonian-Einsteinian gravity, rather than plasma-electromagnetism (weak, strong, and gravity included) as the dominant force binding everything all together.

In the following section, the author will quote from Nehemiah Hawkins’ Electrical Guides³³², and set some of the record straight on proper views as pertains to:

1. Electromagnetism
2. Energy
3. Force
4. Mass
5. Matter
6. Various technical terms
7. Work
8. Power
9. Various quantum terms if related

Hawkins’ Electrical Guides Definitions

1. “1, Electricity and magnetism are one and the same thing; 2, what is really known about it has come as a discovery and not as an invention. Thus, we say the intrepid explorer discovered the pole, not that he invented it.”
2. “Magnets are bodies, either natural or artificial, which have the property of attracting iron, and the power, when freely suspended, of taking a direction toward the poles of the earth.”
3. “By means of simple experiments it may be ascertained that the magnet has the following general properties, viz : 1, power of attraction; 2, power of repulsion; 3, power of communicating magnetism to iron or steel; 4, polarity, or

³²⁷ Flattery to Chinese *feng-shui* (*wind-water*) notwithstanding, the frequent confusion of hydrodynamical terms or references with electromagnetic behaviors in space extend well beyond the idea of a current. They extend into impossible idea, such as “Wind” in space. This is a problem in cometology, for example, where the idea of a “snowball” (an Earthen phenomenon) literally blinds scientists to the obvious collimating “streams” (not jets!) upon comet surfaces. 5/12 of the terms listed are water or fluid related.

³²⁸ “a machine for converting mechanical energy into electrical energy; a [DC] generator.” ~Google
This is, as opposed to some churning mass of magma making a magnetosphere (theoretically).

³²⁹ “magnetohydrodynamics is the study of the effects of a magnetic field (magneto) on the behavior and motion (dynamics) of a fluid (hydro) that is hot enough for electrons to be separated from their host atoms. Such a gas is called a plasma and is often considered to be the fourth state of matter.” [sic] ~NDG Tyson,

<http://www.haydenplanetarium.org/tyson/read/1994/05/01/confused-person%E2%80%99s-guide-to-astronomical-jargon>

³³⁰ Not only is fusion not occurring inside the core of the sun, but the idea of atoms that fuse are “burning” is bogus. Ibid.

³³¹ <http://www.skyandtelescope.com/astronomy-terms/>

³³² <https://sites.google.com/site/electricuniversegateway/home/hawkin-s-electrical-guides>

the power of taking a direction toward the poles of the earth; 5, power of inclining itself toward a point below the horizon.”

4. “magnetism is a department of electrical science which , treats of the properties and effects of the magnet. The same terms are also used to denote the unknown cause of magnetic phenomena, as when we speak of magnetism as excited, imparted, and so on.”
5. “Lightning and the Northern Lights are displays of electricity on a grand scale.”³³³
6. “the term electricity has been used to denote the unknown cause of electrical phenomena, and broadly the science which treats of electrical phenomena and their causes.”
7. “Electricity, whatever it may prove to be, is not matter nor is it energy; it is however a means or medium of transmitting energy.”
8. “If electricity is to transmit or convey energy along a wire, this energy must be imparted to the electricity from some external source, that is to say, before electricity can perform any work it must be set in motion, against more or less resistance. This involves that pressure must be applied, and to obtain this pressure, energy must be expended from some external source.”
9. “Energy may be defined as the capacity for performing work.”
10. “Without the expenditure of energy no useful work can be accomplished.”
11. “Although electricity is not energy, electricity under pressure is a form of energy spoken of as electrical energy.”
12. “In an expenditure of energy in this form, the electricity acts simply as a transmission agent or medium to transmit the energy imparted to it in causing it to flow.”
13. “Usually, mechanical energy is converted into electrical energy, and a dynamo is employed for effecting the transformation.”
14. “Potential energy is the capacity for performing work which a body possesses by virtue of its position.”
15. “Kinetic energy is the capacity for performing work which a body possesses by virtue of its motion.”
16. “Energy cannot be created or destroyed. This is the law known as the conservation of energy.... It teaches further, that energy can be transmitted from one body to another or transformed in its manifestations.”
17. “electricity can not be created or destroyed, although its distribution may be altered.”
18. “Lippman states that every charge of electricity has an opposite and equal charge somewhere in the universe more or less distributed; that is, the sum of positive charges is always equal to the sum of negative charges.”
19. “The true nature of electricity has not yet been discovered. Many think it a quality inherent in nearly all the substances, and accompanied by a peculiar movement or arrangement of the molecules. Some assume that the phenomena of electricity are due to a peculiar state of strain or tension in the ether which is present everywhere, even in and between the atoms of the most solid bodies. If the latter theory be the true one, and if the atmosphere of the earth be surrounded by the same ether, it may be possible to establish these assumptions as facts.”
20. “it is positively assured that electricity never manifests itself except when there is some mechanical disturbance in ordinary matter.”
21. “light itself is founded on electricity, and that light waves are merely electro-magnetic waves.”
22. **“The theory " that; electricity .is related to or identical with, the luminiferous ether," has 'been' accepted -by the most prominent scientists.”**
23. “Electricity, it is also conceded, is without weight, and, while it is without doubt, one and the same, it is for convenience sometimes classified according to its motion, as:
 1. Static electricity, or electricity at rest;
 2. Current electricity, or electricity in motion;
 3. Magnetism, or electricity in rotation;
 4. Electricity in vibration (radiation).”

The Brief Byway into Supersymmetry and M/String -Theory

For 20-30 years, there was a powerful darling of the physics world, before Dark Matter (also) captured the heart of the physics world and (also) failed to predict or exist. String theory, later known as M-theory, part of a broader category of physics known as Supersymmetry (SUSY), was a wonderfully conceived and *elegant*

³³³ “Electricity is a term derived from the Greek word for amber, that being the substance in which a property of the agent now denominated electricity was first observed.” (Hawkin’s Electrical Field Guide, N Hawkins, 1917)

attempt to unite the Quantum and Relativistic worlds, while remaining useful on the standard Newtonian mechanistic level and explaining electromagnetism, gravity, and thermodynamics.

In all of these regards, it failed, and quite spectacularly. The problem likely arose from some of the ridiculous boundary conditions and tenants, which fail on all sorts of levels, including the entry level “what Science is and what it isn’t.”

To start with, String theory required extra dimensions (eventually 7 more for a total of 11). Secondly, it required scales of these open and closed-loop strings that were insanely smaller than even quarks.

Table 10 - Quantum scales

Water Molecule	10^{-9} m
Hydrogen Atom	10^{-10} m
Neutrons and Protons	10^{-15} m
Electrons	10^{-17} m
Quarks ³³⁴	10^{-18} m
Higgs-Boson	10^{-17} m
Graviton/Gravity Wave ³³⁵	10^{-21} m
Proposed strings ³³⁶	10^{-33} m
Planck scale (quanta)	10^{-35} m

In terms of prediction ability, however, Supersymmetry has performed remarkably - remarkably poorly.

- 2010 - SUSY fails first LHC super³³⁷
- 2012 - SUSY officially announced as a failure, predictions wildly off (650 GeV!!)^{338 339}
- 2015 - “beauty” quark found defies Relativity³⁴⁰
- 2016 - Diphoton bump eliminated; LHC can only find Higgs-Bosons³⁴¹
- 2017 - Sparticles continue to “elude” detection³⁴² (can’t find what isn’t there fallacy)
- 2017 - Dark Matter officially fails³⁴³

³³⁴ Technically, they are dimensionless. See Figures 45 and 46.

³³⁵

<https://physics.stackexchange.com/questions/158385/if-gravitational-waves-exist-are-they-technically-just-another-form-of-light-ele>

³³⁶ Note: orders of magnitude are logarithmic, so that strings aren’t 3x smaller than atoms as compared to atoms from us. They are 10 with 23 zeros afterwards times smaller. So small that, obviously they cannot be proven in the least, and are therefore a pseudoscience at best.

³³⁷ <https://www.math.columbia.edu/~woit/wordpress/?p=3338>

³³⁸ <https://www.scientificamerican.com/article/supersymmetry-fails-test-forcing-physics-look-new-idea/>

³³⁹ <https://arxiv.org/pdf/1211.0004v1.pdf>

³⁴⁰ <https://phys.org/news/2015-07-supersymmetry-physics-theory.html>

³⁴¹ <http://backreaction.blogspot.com/2016/08/the-lhc-nightmare-scenario-has-come-true.html>

³⁴² <http://www.theworldin.com/article/12781/so-long-susy?fsrc=scn/tw/wi/bl/ed/>

³⁴³ <https://arxiv.org/pdf/1804.04320.pdf>

→ 2018 - Dark Matter continues to fail³⁴⁴, Dark energy thwarted by new size³⁴⁵ and numbers of stars³⁴⁶ estimates.

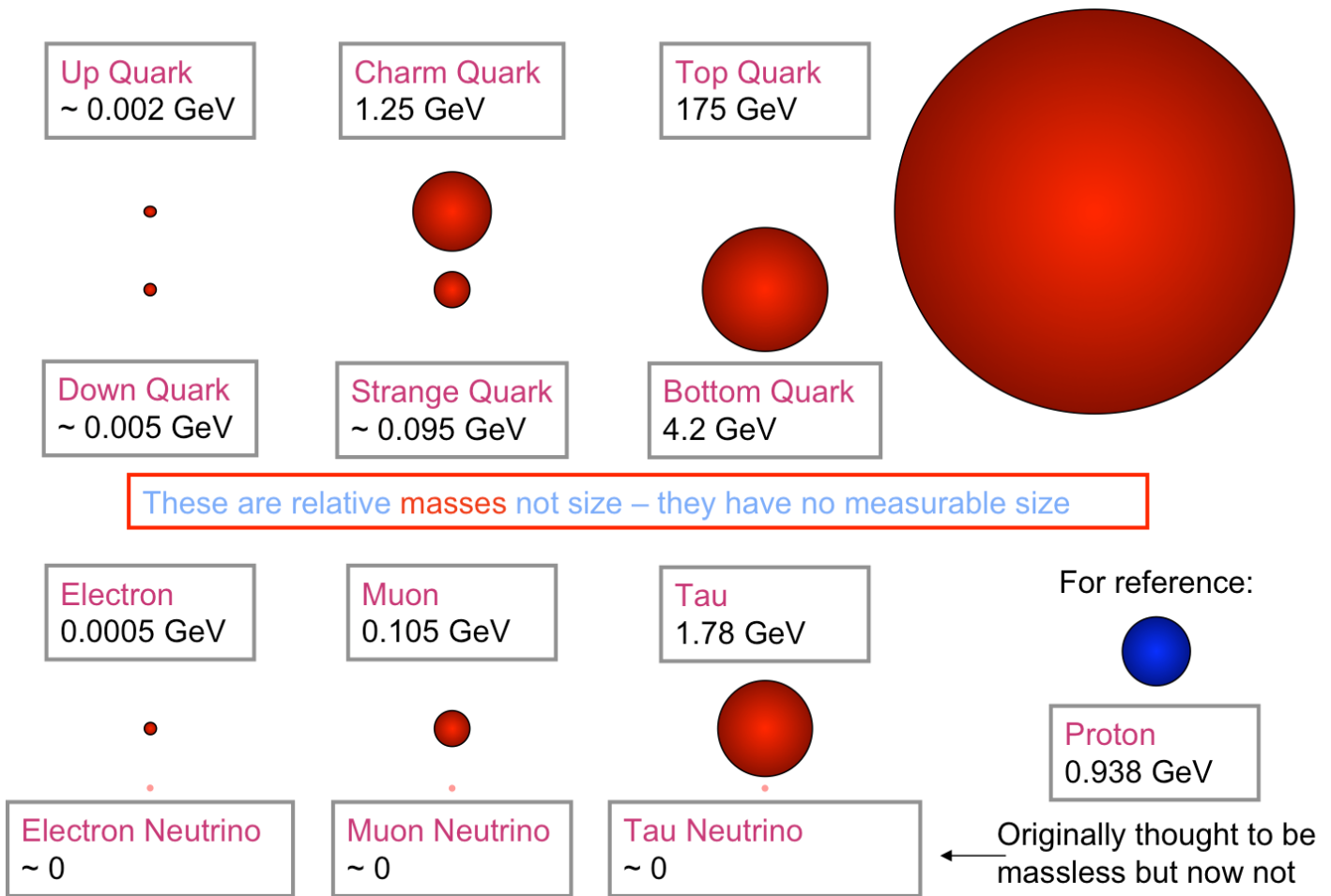

Figure 46 - Quark Masses turned into scales³⁴⁷

The disappointment with SUSY runs deep for many reasons. One was that physics has long had growing fractures (as is to be expected with the number of people failing to study PEM and opting for increasingly outlandish theories) which were sought to be unified under one Unified Field Theory (UFT). Another was that by and large, the majority of high energy physics (HEP) and astrophysical funding goes into Relativity and Quantum mechanics, and yet these two have major disagreements of behavior.³⁴⁸

Finally, astronomers felt as if they were close to creating a final astrophysical cosmology that was complete and promised a bright future of highly speculative mathematically driven “discoveries.” As it turns out, real “telescope” astronomy was just about to throw all of that down the drain as instantly the Universe got denser³⁴⁹, dustier³⁵⁰, and more full of exoplanets³⁵¹ (ones you couldn’t see³⁵².) The stars got smaller³⁵³ and

³⁴⁴ <https://arxiv.org/pdf/1804.00088.pdf>

³⁴⁵ <https://arxiv.org/pdf/1804.03888.pdf>

³⁴⁶

<https://www.nasa.gov/feature/goddard/2016/hubble-reveals-observable-universe-contains-10-times-more-galaxies-than-previously-thought>

³⁴⁷ http://chemphys.armstrong.edu/secrest/Astro/astro_1.html

³⁴⁸ <http://theory.caltech.edu/people/jhs/strings/str115.html>

³⁴⁹ <https://phys.org/news/2017-01-universe-trillion-galaxies.html>

³⁵⁰ <http://sciencenordic.com/cosmic-dust-change-our-understanding-birth-universe>

³⁵¹ <https://news.nationalgeographic.com/2018/02/exoplanets-discovery-milky-way-galaxy-spd/>

³⁵² <https://arxiv.org/pdf/1804.05334.pdf>

smaller³⁵⁴ and dimmer³⁵⁵ and dimmer³⁵⁶, and eventually the pulsars rotated too fast³⁵⁷, the neutron stars were too small³⁵⁸, the astrophysical jets too close to the speed of light³⁵⁹ and too long³⁶⁰ and going the wrong way³⁶¹, and of course galaxies started popping

up that don't conform to Cold Dark Matter expectations³⁶². It was also found that Redshift was, after all, not well understood when Gaia began sending her results³⁶³. As one SUSY founder (of M theory) put it,

*"My papers from that time really radiate enthusiasm," said Shifman, now a 63-year-old professor at the University of Minnesota. Over the decades, he and thousands of other physicists developed the supersymmetry hypothesis, confident that experiments would confirm it.*³⁶⁴
"But nature apparently doesn't want it," he said. "At least not in its original simple form."³⁶⁵

Three Generations of Matter (Fermions)				
	I	II	III	
mass→	2.4 MeV	1.27 GeV	171.2 GeV	0
charge→	$\frac{2}{3}$	$\frac{2}{3}$	$\frac{2}{3}$	0
spin→	$\frac{1}{2}$	$\frac{1}{2}$	$\frac{1}{2}$	1
name→	u up	c charm	t top	γ photon
Quarks	4.8 MeV	104 MeV	4.2 GeV	0
	$-\frac{1}{3}$	$-\frac{1}{3}$	$-\frac{1}{3}$	0
	$\frac{1}{2}$	$\frac{1}{2}$	$\frac{1}{2}$	1
	d down	s strange	b bottom	g gluon
Leptons	<2.2 eV	<0.17 MeV	<15.5 MeV	91.2 GeV ⁰
	0	0	0	0
	$\frac{1}{2}$	$\frac{1}{2}$	$\frac{1}{2}$	1
	ν_e electron neutrino	ν_μ muon neutrino	ν_τ tau neutrino	Z⁰ weak force
	0.511 MeV	105.7 MeV	1.777 GeV	80.4 GeV
	-1	-1	-1	±1
	$\frac{1}{2}$	$\frac{1}{2}$	$\frac{1}{2}$	1
	e electron	μ muon	τ tau	W[±] weak force
				Bosons (Forces)

Figure 45 - Quark Masses (in GeV)

³⁵³ <https://www.wired.com/2017/02/7-earth-like-worlds-orbit-star-cool-didnt-know-existed/>

³⁵⁴ <http://www.eniscuola.net/en/2017/07/18/star-smaller-jupiter-discovered/>

³⁵⁵ <https://www.space.com/12714-coldest-failed-stars-brown-dwarfs-wise.html>

³⁵⁶ https://www.nasa.gov/mission_pages/WISE/multimedia/pia14720.html

³⁵⁷ https://www.researchgate.net/post/Why_dont_fast_spinning_stars_dont_explode

³⁵⁸ <https://medium.com/startsWith-a-bang/ask-ethan-79-the-tiniest-neutron-star-e5808e8fa328>

³⁵⁹ <https://arxiv.org/pdf/astro-ph/0406319> (energies required are exponential)

³⁶⁰ <http://iopscience.iop.org/article/10.1086/382140/pdf>

³⁶¹ <http://www.dailymail.co.uk/sciencetech/article-5200221/Snake-like-filament-probing-galaxys-black-hole.html>

³⁶² <http://astronomy.com/news/2018/03/the-galaxy-devoid-of-dark-matter>

³⁶³ <https://arxiv.org/pdf/1805.03298.pdf>

³⁶⁴ "It is a capital mistake to theorize before you have all the evidence. It biases the judgment. It is a capital mistake to theorize before one has data. Insensibly one begins to twist facts to suit theories, instead of theories to suit facts." ~Sir Arthur Conan Doyle, "Sherlock Holmes"

³⁶⁵ Ibid.

II - Relativity Theory

As discussed previously, Relativity was an already hypothesized phenomenon. Einstein himself did not take the theory of General Relativity overly far, and admitted that he could, indeed, be wrong. As will be shown in the following subsections, the issue of the ether-field proposed by Einstein (space-time) has many numerous and well documented holes, and will need to be reframed. One such reframing could be Distinti's New Electromagnetism. Another might be to go back to the foundations in Poincare's work, and work out what this fourth dimension might *actually* be, or at least perform a new frame up or description. Still simpler, it might merely mean stripping away all of the science fiction that was added into Relativity Theory (such as black holes and wormholes³⁶⁶, white holes³⁶⁷ (holes in space in general), including parts of String theory, such as branes³⁶⁸ and extra dimensions and much, much more. This idea will be covered in MOND.

Einsteinian Mechanics

First we need to understand what time dilation and length contraction are, mathematically. Simply put, their formulas are:

Figure 47 - Time Dilation according to Relativity Theory

$$t' = \frac{t}{\sqrt{1 - \frac{v^2}{c^2}}}$$

Figure 48 - Length Contraction according to Relativity Theory

$$L = L_0 \sqrt{1 - \frac{v^2}{c^2}}$$

The issue that this poses is not with the formulas alone, but with their application. As Stephen Crothers calls it, "Einstein's Fantastical Clocks." Much of this is predicated upon a most assuredly - woefully - bad understanding of what math means in the real physical world.^{369 370}

- Time is not a dimension *proper*, it is a measure of the passage of events of change. Change (as a derivative) might be the fourth dimension (or perhaps volume), but time is not a dimension.
- Space is a void of volume, that is filled with other matter, which has mass but isn't mass itself.
- Mass is electrical charge density (see quanta)
- Energy is a measure of activity level, frequency or vibration rate, or of movement or potential.
- Length Contraction does change one's apparent perception of electromagnetic **age**, but actual space **does not**: bend, fold, ripple, swirl, tear, blow up, expand, contract, or move in any way. (see Figure 49)
- Gravity waves are electromagnetic ripples³⁷¹ - EMF is its own medium; the ether is plasma-electricity.
- Gravitons and photons are not particles; they are rates of induction through the plasma and magnetic field "medium."³⁷²
- Space-time is not a real Aether and cannot be the UF, hence its failure to combine with much more rigorous Quantum Electrodynamics and Quantum Mechanics in general.

³⁶⁶ https://www.youtube.com/watch?v=16_GuYobDZ4

³⁶⁷ https://en.wikipedia.org/wiki/White_hole

³⁶⁸ <https://en.wikipedia.org/wiki/Brane>

³⁶⁹ <https://www.thunderbolts.info/wp/2016/02/19/wal-thornhill-an-examination-of-gravitational-waves-space-news/>

³⁷⁰ Richard Feynman once explained that the physicist must use the mathematical tool to describe something real in real space. <https://www.youtube.com/watch?v=MZZPF9rXzes>

³⁷¹

<https://physics.stackexchange.com/questions/158385/if-gravitational-waves-exist-are-they-technically-just-another-form-of-light-ele>

³⁷² K Wheeler

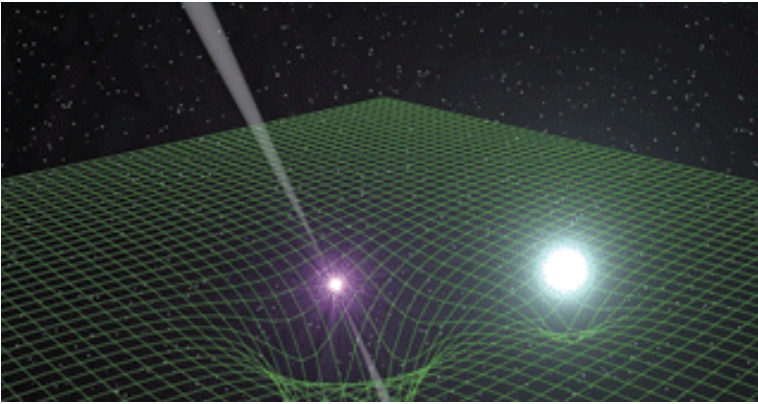

Figure 49 - Bent/Curved Space (this is wrong)³⁷³

Historical Review - Poincare's Gravity Waves

It is easy to see, upon reflection (hindsight is 20/20), that the problem lay in the taking of a pure mathematician's (Poincare) ideas (which he himself called fantasy), and a lesser mathematician (Einstein) abusing them, dividing by zero (so called Schwarzschild Radius^{374 375}), and applying an unpassable parameter³⁷⁶ off as no inconvenience when it should have been a non-starter: the Universe **does not contain one mass**. Those errors will be dealt with in the following subsection.

In 2016 it was announced that Advanced LIGO lab had verified the existence of gravity waves (first detected in 2015)³⁷⁷. Another lab also confirmed this.³⁷⁸ And a third confirmation was published in 2017³⁷⁹. It was, however, perhaps not what they thought. Though it is true that the LIGO interferometers are attuned to sizes smaller than electrons (see Table 10), the fact remains that the atoms of the detector are all electromagnetic materials, and the electromagnetic quarks within them are excited by all sorts of radiation (electricity in vibration/rotation). Furthermore, the original gravity waves hypothesized by Henri Poincare, who certainly would have understood the maths better than Einstein could have, were in fact electromagnetic derivations from Maxwell's equations.

Given that gravity is electromagnetic, the simple reality is easily solved: what LIGO and Virgo detected³⁸⁰ was, in fact, electrogravitics, if anything at all.^{381 382 383 384}

³⁷³ There are 3 proofs of the invalidity of this diagram. The first proof is that it relies on the Newtonian concept of weight, despite belonging to Einsteinian mechanics. The second is that down (and up) is arbitrarily assigned, as well as a 2D space-time fabric but it uses 3D objects (mathematically inconsistent). The third proof is that if there was a bowl, all objects would fall towards the center, and either gain energy or have to leave the bowl and decelerate, losing energy and momentum. We find instead that velocity does not decrease, yet bodies remain in orbit or even slowly move away, despite supposed "bending" pushing them towards the center. While it is true that *light* has been shown to bend or refract, this hasn't been shown to be true microlensing (see subsection below). In fact it may mostly be an aging light (so called "tired light") rather than pure relativistic effects. It is certainly true that some concepts of time dilation have been proven with experiments in space, their meanings have been misinterpreted to be about space-time, rather than the changes inherent in electromagnetic signals as they travel back and forth to objects in differential reference frames.

³⁷⁴ https://en.wikipedia.org/wiki/Schwarzschild_radius ; R=0

³⁷⁵ <http://www.worldnpa.org/php2/index.php?tab0=More&tab1=Media&tab2=Display&id=180>

³⁷⁶ One would think this would stop anyone from continuing to formulate a theory. However, as Bohr once said, "We are all agreed that your theory is crazy. The question which divides us is whether it is crazy enough to have a chance of being correct." Thinking like this precludes simplism and easily found answers (such as those already in front of you).

³⁷⁷ https://en.wikipedia.org/wiki/First_observation_of_gravitational_waves

³⁷⁸ <http://www.caltech.edu/news/ligo-and-virgo-make-first-detection-gravitational-waves-produced-colliding-neutron-stars-80082>

³⁷⁹ <https://www.space.com/38471-gravitational-waves-neutron-star-crashes-discovery-explained.html>

³⁸⁰ If they detected it at all; there have been some claims of fraud due to the size of the prize money for finding them, including Nobel Prizes.

https://www.researchgate.net/post/Is_LIGO_guilty_of_Scientific_Fraud

Stephen Crothers vs. Einstein

Already the works of Stephen Crothers have been cited already. However some of the main points brought up in these papers and presentations should be expanded upon slightly, as Crothers has done the *unimaginable thing*: reviewing the actual maths of Einstein and Schwarzschild's solutions for inconsistencies, errors, logical fallacies, and internal consistency and extrinsic consistency with the mainstream cosmology in general. Such activity deserves either lauding or crucifixion, which is probably what the mainstream would prefer.

Asymmetry and the Big Bang

The primary problem, which without a deep analysis through mathematics, a physicist or other student would be led past without questioning, is that there is a deep, **irreconcilable** difference between a Big Bang Universe and a Black Hole Universe, which is descended from Relativity theory:

Table 11 - Mutual Exclusion of Big Bang and Black Holes

All Black Hole Universes ³⁸⁵	All Big Bang Universes
(1) Spatially infinite	(1) Spatially finite (k=1) or spatially infinite (k=-1,k=0)
(2) Eternal	(2) Finite age (~13.8 billion yr)
(3) Contain only one mass	(3) Contain many masses and radiation
(4) Not expanding (static, stationary)	(4) Expanding (non-static)
(5) Asymptotically flat (or asymptotically curved)	(5) Not asymptotically anything
(6) No k-curvature	(6) k-curvature ³⁸⁶

Credit: S Crothers [sic]

These differences are due to Lorentzian transformations³⁸⁷ of the theory of Special Relativity, primarily, but also, if one will note: also of the differences of the physics which the astronomical community speaks about, but never as a contradiction (though it obviously is).

In particular, the author wishes to draw attention to the asymmetry that exists between the age, size, and mass. The issue of expansion is not clear in Relativity Theory (though there is a massless constant observer, so presumably an absolute, infinite space). But the issue of size itself, and of age in particular (as

³⁸¹ <http://vixra.org/abs/1603.0127>

³⁸² <http://plasma.pics/problems-with-the-ligo-gravitational-wave-discovery/>

³⁸³ <http://mathforum.org/kb/thread.jspa?threadID=2886811>

³⁸⁴ https://www.researchgate.net/post/Did_LIGO_and_Virgo_detect_the_alleged_Gravitational_Waves_in_3D_or_in_4D

³⁸⁵ <https://www.youtube.com/watch?v=QBorBKDnE3U>

³⁸⁶ <https://www.sciencedirect.com/science/article/pii/S0926224509001168>

³⁸⁷ https://www.researchgate.net/publication/314299910_On_the_Logical_Inconsistency_of_the_Special_Theory_of_Relativity

size and age are related via the distance unit: light-year), is a clear one: with Einsteinian Relativity at its base, either Big Bang is impossible, or Black Holes are, **or both**.^{388 389}

“Each and every black hole is an independent universe by its very definition, no less than the Big Bang universes are independent universes, because the black hole universe is not contained within its event horizon. Its spacetime extends indefinitely far from its singularity. All types of black hole universes are spatially infinite and eternal, and are either asymptotically flat or, in more esoteric cases, asymptotically curved. There is no bound on asymptotic, for otherwise it would not be asymptotic. Thus every type of black hole constitutes an independent infinite and eternal universe; bearing in mind also that each different type of black hole universe pertains to a different set of Einstein field equations and therefore have nothing to do with one another. Without the asymptotic condition the black hole equations do not result, and one can then write as many non-asymptotic solutions to the corresponding Einstein field equations for the supposed different types of black holes as one pleases [4,7], none of which produces a black hole.”

“Black holes were first discovered as purely mathematical solutions of Einstein’s field equations. This solution, the Schwarzschild black hole, is a nonlinear solution of the Einstein equations of General Relativity. It contains no matter, and exists forever in an asymptotically flat space-time.” Dictionary of Geophysics, Astrophysics and Astronomy [9]

“The Kerr-Newman solutions ... are explicit asymptotically flat stationary solutions of the Einstein-Maxwell equation ($\lambda = 0$) involving just three free parameters m , a and e the mass, as measured asymptotically, is the parameter m (in gravitational units). The solution also possesses angular momentum, of magnitude am . Finally, the total charge is given by e . When $a = e = 0$ we get the Schwarzschild solution.” Penrose [10]

“The charged Kerr metrics are all stationary and axisymmetric ... They are asymptotically flat...” Wald [11]³⁹⁰ [sic, underline added]

The problem for Big Bang cosmology and Einstein doesn’t stop here. It actually recedes all the way back to the inception.

According to Hans Alfvén, “I was there when Abbe George Lemaitre first proposed his theory” [sic]

Crothers writes,

“Lemaitre was, at the time, both a member of the Catholic hierarchy and an accomplished scientist. Alfvén reported that Lemaitre said in private that this theory was a way to reconcile science with St. Thomas Aquinas’ theological dictum of creatio ex nihilo or creation out of nothing.

“In January 1933, Georges Lemaitre travelled with Albert Einstein to California for a series of seminars. After Lemaitre detailed his Big Bang theory, Einstein stood up, applauded, and said “This is the most beautiful and satisfactory explanation of creation to which I have ever listened.”

*“Thus Big Bang is theology, not science. Lemaitre allowed his theological convictions to **PREDETERMINE** the outcome of a scientific inquiry. This violates scientific method.” [sic]³⁹¹*

The author must agree.

³⁸⁸ <http://blogs.discovermagazine.com/crux/2014/03/07/einsteins-lost-theory-describes-a-universe-without-a-big-bang/#.Wx1qd-4vvdU>

³⁸⁹ <https://www.nationalgeographic.com/magazine/2005/05/einstein-relativity-cosmology-space-time-big-bang/>

³⁹⁰ [http://www.inerton.kiev.ua/nogravwaves_S.Crothers\(2016\)_vixra.1603.0127v3.pdf](http://www.inerton.kiev.ua/nogravwaves_S.Crothers(2016)_vixra.1603.0127v3.pdf)

³⁹¹ <https://www.youtube.com/watch?v=CHZ5O0jTH8A>

The Schwarzschild Radius

$$ds^2 = c^2 \left(1 - \frac{2Gm}{c^2 r}\right) dt^2 - \left(1 - \frac{2Gm}{c^2 r}\right)^{-1} dr^2 - r^2 (d\theta^2 + \sin^2 \theta d\varphi^2)$$

$$0 \leq r$$

The '**Schwarzschild radius**' is, $r_s = \frac{2Gm}{c^2}$

Hence,

$$c = \sqrt{\frac{2Gm}{r_s}} \quad \text{Escape speed!}$$

Figure 50 - The Schwarzschild Radius defined; credit: S Crothers³⁹²

The Radius in Hilbert's Metric

$$R_p = \int \left(1 - \frac{\alpha}{r}\right)^{\frac{1}{2}} dr$$

$$= \sqrt{r(r-\alpha)} + \alpha \ln \left(\frac{\sqrt{r} + \sqrt{r-\alpha}}{\sqrt{\alpha}} \right)$$

$R_p = 0$ when $r = \alpha = 2Gm/c^2$.
There is no possibility for $0 \leq r$.

Hilbert's 'r' is,

- (1) The areal radius;
- (2) The coördinate radius;
- (3) The radius; (e.g. Gerardus 't Hooft, Nobel Laureate)
- (4) The distance; (e.g. Gerardus 't Hooft, Nobel Laureate)
- (5) The radial coördinate; (e.g. Gerardus 't Hooft, Nobel Laureate)
- (6) The radius of a 2-sphere;
- (7) The reduced circumference;
- (8) The radial space coördinate;
- (9) A gauge choice; it defines the coördinate r .
(Gerardus 't Hooft, Nobel Laureate)

Figures 51 and 52 - Hilbert's solution; credit: S Crothers

Schwarzschild's Solution

$$ds^2 = \left(1 - \frac{\alpha}{R}\right) dt^2 - \left(1 - \frac{\alpha}{R}\right)^{-1} dR^2 - R^2 (d\theta^2 + \sin^2 \theta d\varphi^2)$$

$$R = (r^3 + \alpha^3)^{\frac{1}{3}} \quad 0 \leq r$$

Note: here $c = 1$.

Hilbert's solution is **not equivalent** to Schwarzschild's.

Figure 53 - Schwarzschild's Solution; credit: S Crothers

³⁹² Ibid. All of the following diagrams are from the same presentation, "A Case in Numerology"

As one can see, especially after viewing the presentation, there are some especially unique problems with defining the radius. “Of course, no astronomer in his right mind would claim that ‘r’ stands for a spatial radius,” Gerardus ‘t Hooft

Ironically, of course, there is no other possible definition for a radius; and there is no particular other way to have a radius in space - *any space* but spatially. Everything else is absolute nonsense.

Setting Equivalent Solutions

Set $r_0 = 0, n = 3, r > r_0 \rightarrow$ Schwarzschild’s solution

Set $r_0 = \alpha, n = 1, r > r_0 \rightarrow$ Droste’s solution

Set $r_0 = 0, n = 1, r > r_0 \rightarrow$ Brillouin’s solution

Can Droste’s solution be extended to $0 \leq r$ to produce Hilbert’s solution (and hence a black hole)?

No, it can’t!

Figure 54 - Inconsistencies in Relativity Theory for ‘r’; credit: S Crothers

Gaussian Curvature

The intrinsic geometry of a surface is entirely independent of any embedding space. The surface in Hilbert’s metric is,

$$ds^2 = r^2 d\theta^2 + r^2 \sin^2 \theta d\varphi^2$$

Its Gaussian curvature K is calculated by,

$$K = \frac{R_{1212}}{g}$$

$$g = \begin{vmatrix} r^2 & 0 \\ 0 & r^2 \sin^2 \theta \end{vmatrix}$$

$$R^1_{.212} = \frac{\partial \Gamma^1_{22}}{\partial x^1} - \frac{\partial \Gamma^1_{21}}{\partial x^2} + \Gamma^k_{22} \Gamma^1_{k1} - \Gamma^k_{21} \Gamma^1_{k2}$$

$$R_{\mu\nu\rho\sigma} = g_{\mu\lambda} R^{\lambda}_{\nu\rho\sigma}$$

$$\Gamma^i_{ij} = \Gamma^i_{ji} = \frac{\partial \left(\frac{1}{2} \ln |g_{ii}| \right)}{\partial x^j}$$

$$\Gamma^i_{jj} = -\frac{1}{2g_{ii}} \frac{\partial g_{jj}}{\partial x^i} \quad (i \neq j)$$

So the Gaussian curvature is,

$$K = \frac{1}{r^2}$$

14

Figure 55 and 56 - The “curvature” of space; credit: S Crothers

Very clearly the radius may not be 0 in the least as one cannot divide by 0 at all.³⁹³ Such mathematical mistakes apparently did not stop Einstein.³⁹⁴

³⁹³ 1/0 is not infinity.

³⁹⁴ <https://arxiv.org/ftp/arxiv/papers/0805/0805.1400.pdf>

Charge Neutrality or Not?

Perhaps an even more difficult inconsistency within the solutions of Relativity, is the issue of whether or not proposed Black Holes are, after all, charged and able to rotate.

Generalisations

Schwarzschild 'black hole':- charge neutral, no rotation.

Reissner-Nordström 'black hole':- charged, no rotation.

Kerr 'black hole':- charge neutral and rotates.

Kerr-Newman 'black hole':- charged and rotates.

What is the overall ground-form?

Figure 57 - Summary of solutions; credit: S Crothers

The concept of different forms of black holes is not admitted publicly.³⁹⁵ All are treated as the same by the mainstream, and by the media. Yet, this also explains how the classic black hole³⁹⁶ is known as being an entire star in the size of a .³⁹⁷ while the media frequently cites black holes of all sorts of [non-spatial] "sizes"³⁹⁸ and in any number of them³⁹⁹.

The One Mass Problem

One of the less known truths about Relativity Theory, is that it literally relies upon the supposition of a single mass in all of the Universe.⁴⁰⁰

"The work that Roger Penrose and I did between 1965 and 1970 showed that, according to general relativity, there must be a singularity of infinite density, within the black hole," Stephen Hawking

" Note the invalid superposition of the two 'Schwarzschild' or 'Kerr' black holes, due to violation of their asymptotic flatness (each encounters infinite spacetime curvature i.e. infinite gravity, at the singularity of the other). The Kerr configuration subsumes the Schwarzschild configuration and so depends upon the existence of the latter. The Schwarzschild solution has no physical meaning because it is the solution to a set of physically meaningless equations (see §7 below). Furthermore, all black hole equations are obtained by violations of the rules of pure mathematics, as will now be proven.

Einstein's field equations 'in the absence of matter' are, $R_{\mu\nu} = 0$ "⁴⁰¹

³⁹⁵ https://www.nasa.gov/audience/foreducators/topnav/materials/listbytype/Black_Hole_Math.html

³⁹⁶ <http://iopscience.iop.org/article/10.1088/0264-9381/17/2/701/pdf>

³⁹⁷ <http://www.rebresearch.com/blog/simple-view-of-black-holes/>

³⁹⁸ http://hubblesite.org/reference_desk/faq/answer.php.id=62&cat=exotic

³⁹⁹ <https://physics.stackexchange.com/questions/175397/minimum-size-of-black-hole>

⁴⁰⁰ <https://www.youtube.com/watch?v=Q185InpONK4>

⁴⁰¹ Ibid.

The fact that this one mass is infinite, and yet contains no matter (and is unknown as to its charge and rotation), and thus is **called a Singularity** is both confusing and illogical, and is - strictly speaking - unscientific by definition. It must, therefore, be stricken from the running for any sort of consideration as a solution to the Unified Aether, and Unified Field solutions in general. The reliance of SUSY upon it, probably explains the former's failures in general. While Special Relativity is based upon electromagnetism and electrogravitics, SUSY is based upon pure mathematical fantasy, and reflects nothing in reality, at all. It is elegant precisely because it, like junk food, appeals to certain order-sensitive functions of the brain. It is abstract, like art. And like abstract art, it really has no use or basis in reflecting reality. See figures 58 and 59.



Figure 58 Abstract Art; credit: NaldzGraphics⁴⁰²

The energy-momentum of Einstein's matter alone is contained in his energy-momentum tensor $T_{\mu\nu}$. To account for the energy-momentum of his gravitational field alone Einstein introduced his pseudotensor t^α_σ , defined by (Einstein [40 §15]),

$$\kappa t^\alpha_\sigma = \frac{1}{2} \delta^\alpha_\sigma g^{\mu\nu} \Gamma_{\mu\beta}^\lambda \Gamma_{\nu\lambda}^\beta - g^{\mu\nu} \Gamma_{\mu\beta}^\alpha \Gamma_{\nu\sigma}^\beta \quad (8.1)$$

where κ is a constant and δ^α_σ is the Kronecker-delta.

"The quantities t^α_σ we call the 'energy components' of the gravitational field". Einstein [40 §15]

But t^α_σ is not a tensor. As such it is a coordinate dependent quantity, contrary to the basic coordinate independent tenet of General Relativity.

Figure 59 - Abstract Math; credit: S Crothers et al...⁴⁰³

Black Holes are Not Consistent with General Relativity

To make matters worse, Black Holes, which are an abstract solution for Special Relativity, are not even consistent within General Relativity.

Quoting Stephen Crother's...

*"Einstein says if $T_{uv}=0$, G_{uv} reduces to R_{uv} for 'empty space' so "outside a body"
 $Ric = R_{uv} = 0$*

⁴⁰² <https://naldzgraphics.net/abstract-art-painting/>

⁴⁰³ Ibid. Crothers calls this equation "Math Salad"

What then is the **SOURCE** of the gravitational field “outside a body”? Einstein says in relation to Hilbert’s solution for $Ric = 0$,

“... M denotes the sun’s mass centrally symmetrically placed about the origin of coordinates.”
(Einstein, A., *The Meaning of Relativity*, Science Paperbacks, Methuen & Co., 1967)

This is a subtle circular play on the words “outside a body” and is therefore **INVALID**. $Ric = 0$ contains **NO MATTER** by mathematical construction and hence **THERE IS NO BLACK HOLE!** [sic]

He goes on in the EU 2013 presentation to present multiple proofs that black holes are not real, and of course not consistent with General Relativity, which, as mentioned before is an electromagnetic solution to the 4-3 problem of Poincare’s Lorentzian transformations.

Einstein’s Fantastical Clocks

Finally, to complete the coup (although there are others, such as the aforementioned critical analysis of Gravity Waves), Crothers deals with the wildly inconsistent and extraordinarily convenient conditions used in Einstein’s paper on General Relativity: the “fantastical clocks”.

“It has recently been proven by Engelhardt [1] that Einstein’s method of synchronising clocks in his Special Theory of Relativity is inconsistent with the Lorentz Transformation. This inconsistency is in fact due to an inherent logical contradiction in Special Relativity, because Einstein incorrectly assumed that systems of clock-synchronised stationary observers are consistent with the Lorentz Transformation.

“Now, however, as we know how to judge whether two, or more, clocks show the same time simultaneously and run in the same way, we can very well imagine as many clocks as we like in a given CS. The clocks are all at rest relative to the CS. They are ‘good’ clocks and are synchronised, which means that they show the same time simultaneously.” [2 §3]

“We have so far defined only an ‘A time’ and a ‘B time.’ We have not defined a common ‘time’ for A and B, for the latter cannot be defined at all unless we establish by definition that the ‘time’ required by light to travel from A to B equals the ‘time’ it requires to travel from B to A. Let a ray of light start at the direction of A, and arrive again at A at the ‘A time’ t’A.”

“In accordance with definition the two clocks synchronize if $tB - tA = t'A - tB$.” [3, §3]” [emphasis added]⁴⁰⁴

Crothers goes on to say,

“In § 2 I mathematically construct a system of stationary observers and apply the Lorentz Transformation to prove that no observer can be clock-synchronised. In § 5 I mathematically construct a system of clock-synchronised observers and apply the Lorentz Transformation to prove that not all observers are stationary.

“That systems of clock-synchronised stationary observers are logically inconsistent with the Lorentz Transformation entirely subverts the Theory of Relativity...”⁴⁰⁵ [emphasis added]

“Physicists since Einstein have only ever invoked the case of observer $\sigma = 1$ in table 1; in other words they have only ever considered this one observer in the system K, on the incorrect assumption that any desired system of observers can be a system of clock-synchronised stationary observers consistent with the Lorentz Transformation. From this incorrect assumption they conclude that the conditions and effects are the same for all observers in the system K; hence a common time dilation and length contraction relative to any and all observers of a moving system....”

“By his clock synchronisation method Einstein attempted to ensure that time at all places within a given stationary system of observers is the same, despite subsequently invoking the Lorentz

⁴⁰⁴ Ibid.

⁴⁰⁵ Ibid.

Transformation. Yet clock-synchronised stationary systems of observers are inconsistent with the Lorentz Transformation. Special Relativity is thereby invalid due to an insurmountable logical contradiction. Systems of clock-synchronised stationary observers are Galilean.

“Einstein [3, §1] defined time by means of his clocks. However, time is no more defined by a clock than pressure is defined by a pressure gauge, speed by a speedometer, heat by a thermometer, or gravity by a spring. Measuring instruments are invented to measure something other than themselves.

“Einstein’s clocks measure only themselves. By defining ‘time’ by his clocks, Einstein detached time from physical reality. Nonetheless, all textbook writers on the subject reiterate Einstein’s false assumptions, for example [4-18]. They all suffer, necessarily, from the same logical inconsistency as Einstein’s 1905 paper.”⁴⁰⁶

Wal Thornhill & Edward Dowdye Destroy General Relativity

In closing up on the failures of Relativity Theory as a Unified Theory, Wal Thornhill and Edward Dowdye fill in some more aspects of the story which further illuminates the issue. Before covering that, the reader should be reminded that:

1. Relativity is not consistent with laboratory quantum mechanics and quantum electrodynamics.
2. It is a misunderstood, borrowed idea from Lorentzian transformations of Maxwell’s laws (which are not 100% accurate).
3. It is mathematically internally and externally inconsistent.
4. Gravity Waves, if they are found,⁴⁰⁷ are most likely to be proof of electrogravitics or quark gravitics.
5. It is not testable in lab⁴⁰⁸, so one must rely on space.

So, the remaining questions are these:

1. Do redshift and light-speed measurements uphold GR?
2. Is there *gravitational* microlensing? (see figure 60)

The answers, as it turns out are: yes, but Redshift is wrong and has been wrong for some time - now proven by Gaia; and no, there has never been final proof of *macrolensing*, only solar corona thermo-electric (plasma) *refraction* within the distance of $R=1$ ⁴⁰⁹.

Figure 60 - Proposed macro-lensing; credit: J. Richard, CRAL; and J.-P. Kneib, LAM

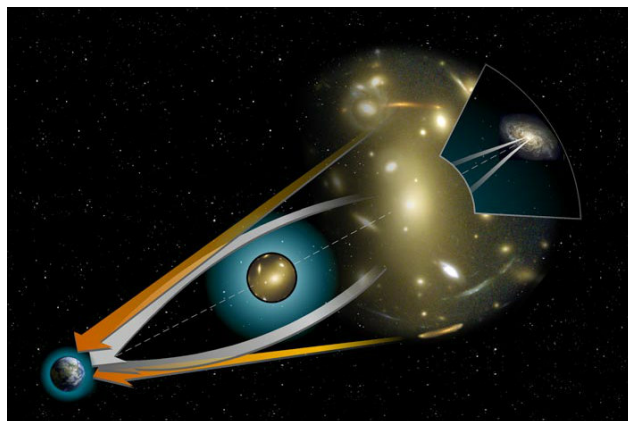

Wal Thornhill Sees Red

Halton Arp proposed his theory of “Intrinsic Redshift”⁴¹⁰ more than 40 years ago. Since then, a small group of outspoken astronomers⁴¹¹ and scientists and engineers have steadily pointed to the weakness of the

⁴⁰⁶ Ibid.

⁴⁰⁷ Most solutions to Gravity Waves are linearized, but GW are a non-linear field. Mathematically unsound! See Ibid.

⁴⁰⁸ Again, relativistic effects of particles in quantum electrodynamics only prove Poincare correct, not Einstein’s space-time.

⁴⁰⁹ https://www.theepochtimes.com/former-nasa-physicist-disputes-einsteins-relativity-theory_739183.html

⁴¹⁰ <https://www.youtube.com/watch?v=EckBfKPAGNM>

⁴¹¹ <https://www.youtube.com/watch?v=KmotCQCxQEI>

[sole] use of light's redshift values (as measured by spectroscopy) to determining both age *and* distance in astronomy. The reasons are threefold:

1. Light very well may lose power as it “ages” traveling through a dusty, magnetic-field filled, charged plasma medium in space, even if sparse.
2. Relying on a single measurement for two values is logically circular and lacks verification.
3. It relies on the assumption of constancy, which has proven generally very unreliable.⁴¹²

For a full understanding of Thornhill's position see his website holoscience.com or watch several of the Thunderbolts Projects EU conference videos⁴¹³.

Dowdye (of NASA) Doubts Macrolensing

Dowdye provides several layers for his deconstruction of macrolensing and GR theory in general:

1. Gravitational deflection of Light and Microwaves⁴¹⁴ (See Figure 61)
 - a. Minimum-Energy-Path of Light Rays in Solar Plasma Rim
 - b. Gauss's Law applied to Impact Parameter from Solar Rim out to Multiple Solar Radii
 - c. Shapiro Delay; a Frequency Dependent Transit Time Effect due to solar wind and plasma
 - d. Angular Deflection of All Electromagnetic Waves are observed only at the solar plasma limb
 - e. A Mösbauer-Pound Rebka Model for gravitational potential gradient found to be in consistency with an indirectly interacting gravitational-electromagnetism light deflection model

Distance h above plasma in units of solar radii R $R_{SUN} = 696,000 \text{ km}$ $r = R_{SUN} + h$	Acceleration g_{SUN} $1/r^2$ Effect	Acceleration m/s^2 $1/r^2$ Effect	Observed Lensing	Predicted by General Relativity $1/R$ Effect $R = R_{SUN} + h$
$h = 1.0, r = 2.0 R_{SUN}$	$0.25 g_{SUN}$	68.5 m/s^2	none	0.88 arcsec
$h = 0.5, r = 1.5 R_{SUN}$	$0.44 g_{SUN}$	121.8 m/s^2	none	1.17 arcsec
$h = 0.2, r = 1.2 R_{SUN}$	$0.69 g_{SUN}$	190.3 m/s^2	none	1.45 arcsec
$h = 0.1, r = 1.1 R_{SUN}$	$0.83 g_{SUN}$	226.4 m/s^2	negligible or none	1.59 arcsec
$h = 0, r = 0$	$1.00 g_{SUN}$	274.0 m/s^2	1.75 arcsec	1.75 arcsec



Figure 61 - No lensing Observed; credit: E Dowdye

⁴¹² A priori knowledge and the reliance on constancy are two of Science's main unscientific hiccups. Assumption is another one. Take for instance the belief that the sun has internal fusion. It follows then that the sun's mass is *increasing* via fusion. However, that assumption is later proven wrong by *actual* measurementation:

<https://gizmodo.com/test-of-einsteins-theory-shows-the-sun-is-losing-mass-182221120>

⁴¹³ <https://www.youtube.com/watch?v=nV7JX9BZDMs>

⁴¹⁴ <http://www.extinctionshift.com/SignificantFindings01.htm>

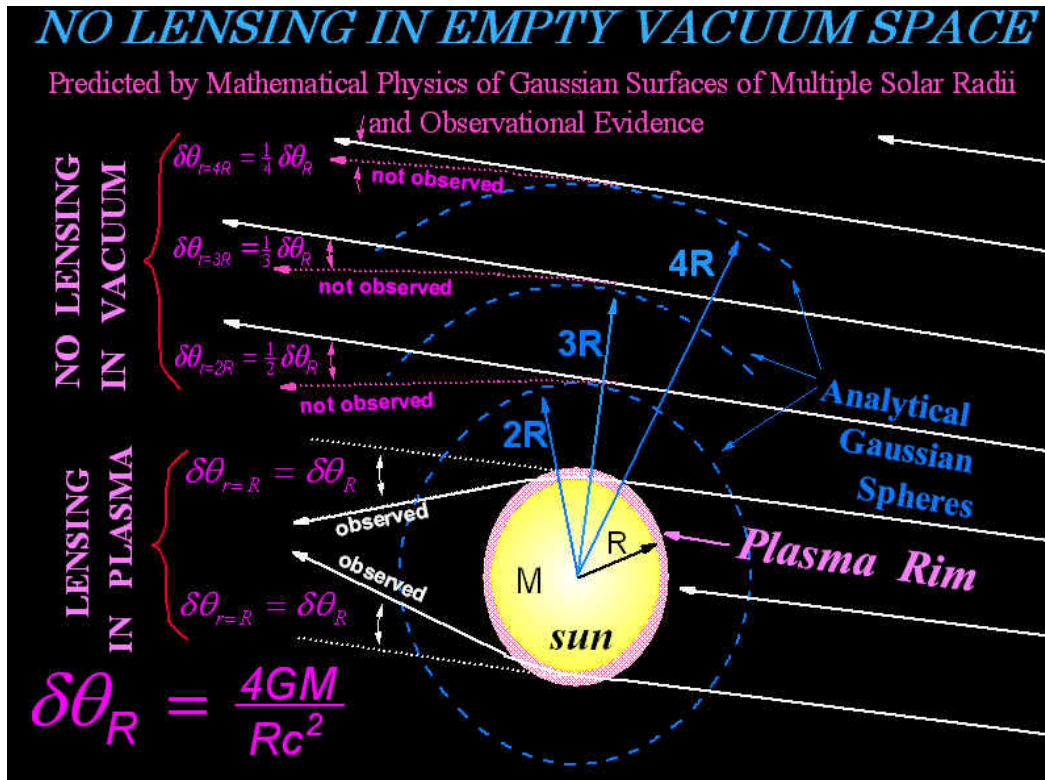

Figure 62 - Gaussian Spheres in Space; credit: E Dowdye

2. Gauss's Gravitational Law

- "If the light bending rule of General Relativity were actually valid, then the night sky should be filled with Einstein rings, since there are many instances where the observer, a star acting as a lens and another star that is acting as a source happen to lie on or close to a direct line-of-sight.
- Within current technical means, the light bending effect of the sun should be easily detectable well beyond the thin plasma rim of the sun, in the plasma-free vacuum space for distances of several solar radii.
- It is important to note that only microwaves resonate with the solar plasma and the dense electrons of solar winds.** The solar winds have virtually **no effects at all** on the path or the propagation velocity of electromagnetic waves in the **infrared, optical** or **ultraviolet** portion of the spectrum.
- The **electron density profile of the solar winds** have a measurable a frequency dependent and impact parameter dependent transit time effect on electromagnetic waves only in the microwave frequency spectrum (plasma resonance). (**Shapiro Effect**)
- The light emitted from the rapidly moving stars, moving along precise elliptical paths about Sagittarius A*, strictly according to Kepler's laws, shows absolutely no evidence of a gravitational light bending effect or distortions as revealed in the recorded images of this region to this date; a region intensely observed by the astrophysicists since 1992.
- The gravitational effect that would be noted at the surface of an analytical Gaussian sphere does not care at all about the size or radius of the mass that is enclosed within the Gaussian sphere. We can see from Gauss's Law that the enclosed mass spheres of different radii and equal masses will present equal gravitational effects at the surface of the analytical Gaussian surface of radius R.⁴¹⁵ [sic]

⁴¹⁵ <http://www.extinctionshift.com/SignificantFindings02.htm>

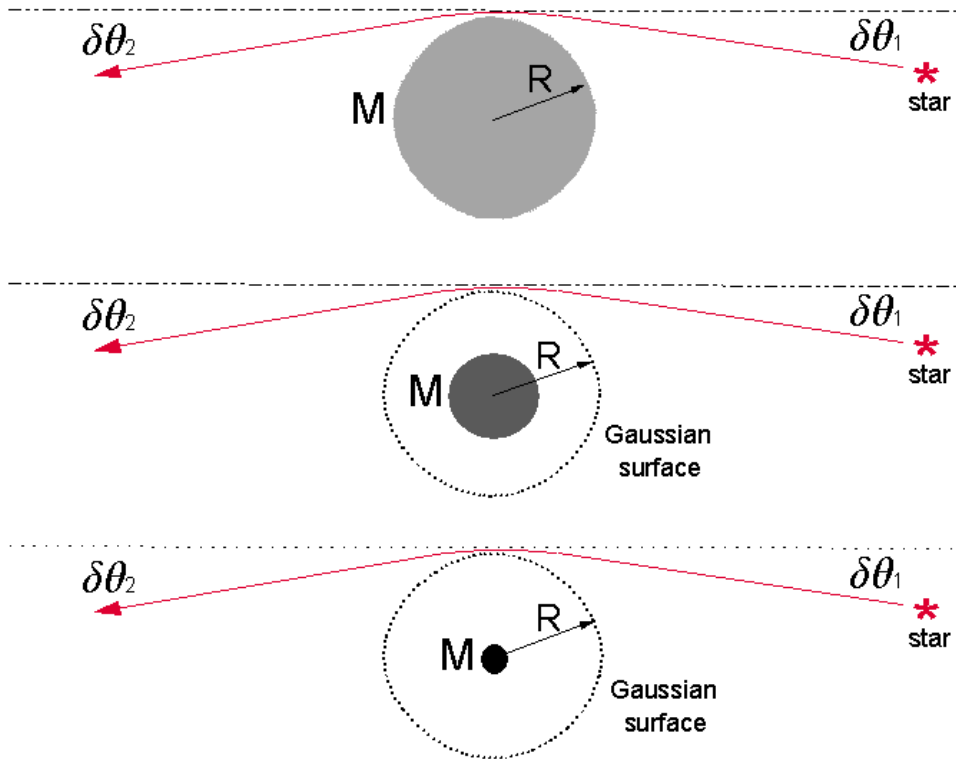

Figure 63 - Gauss's Surface Law applied to Equal Gravitating Masses Enclosed; credit: Dowdye

3. Einstein Ring Calculations and Principle of Reciprocity⁴¹⁶
4. Principle of Reciprocity and Gauss's Law of Gravity applied to Einstein Ring and Solar Light Bending⁴¹⁷
 - a. See Table 12
 - b. The main point is that *if* lensing were a matter of gravity bending EMF signals, it should happen everywhere which would greatly distort light coming from the stars. It would, in effect, be a huge collage of bent signals.
5. The Shapiro Delay⁴¹⁸
 - a. This has been used *inappropriately* to prop up macro-lensing, but its curve does not fit GR predictions (see Figure 64)
 - b. *"The Shapiro delay is merely a very good fit to the data dealing with the transit times of the microwave signals as function of the selected microwave frequencies of the transmitted link and as affected by the space properties of the solar wind that govern the propagation of microwaves signals in space. The Shapiro delay is the determination of the transit-time delay (usually expressed in microseconds) due to the influence of the expanding solar atmosphere (solar wind) of a measurable electron profile. The Shapiro delay has nothing at all to do with space-time or the gravitational solar light bending effect of General Relativity (usually expressed in radians or seconds of arc)."*⁴¹⁹

⁴¹⁶ <http://www.extinctionshift.com/SignificantFindings03.htm>

⁴¹⁷ <http://www.extinctionshift.com/SignificantFindings05.htm>

⁴¹⁸ <http://www.extinctionshift.com/SignificantFindings06B.htm>

⁴¹⁹ Ibid.

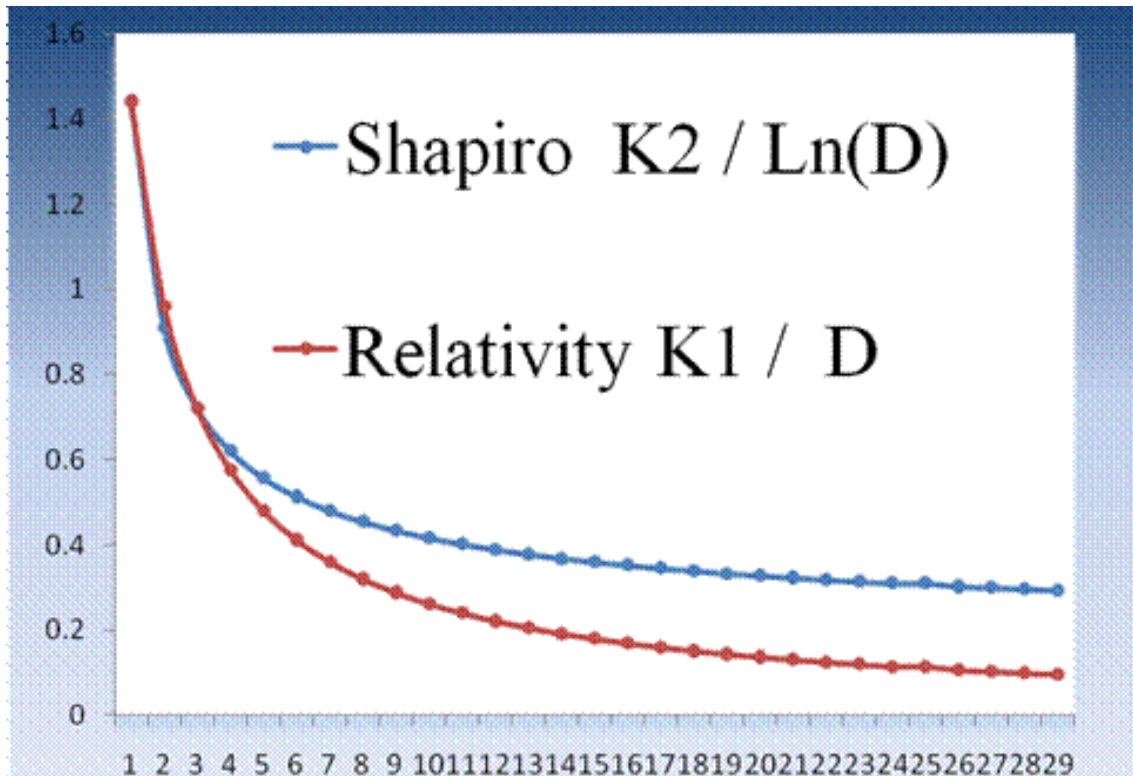

Figure 64 - Scaled Comparison of the logarithmic $1/\ln(D)$ Shapiro Delay; credit: E Dowdye

6. No Gravitational Light Bending at SGR A*⁴²⁰
7. False Alarms in galactic photographs, caused by wavelength errors.⁴²¹
 - a. *“Of all the alleged gravitational lensing galaxies, the one clear fact is that the images all have a wavelength dependency. This is consistent with the fact that there is a clear wavelength dependency on the scattering of the light from the interstellar and intergalactic dust and is a function of the grain size and the distribution of the grains of dust. Viewing these alleged gravitational lensing galaxies in other wavelengths, i.e., using wavelength filters to allow recording of the images in IR or in UV, then these features will all appear to be entirely different, not resembling their usual features. Recall that according to the light bending rule of General Relativity, the gravitational light bending effect should be totally independent of the frequency of the gravitationally bent light ray.” (Dowdye)*
8. The misappropriation of Earth’s Gravitational effects to quantum clock experiments as GR⁴²²
 - a. *“The gravitational forces acting on an atomic clock in orbit is cancelled by the centrifugal forces acting on it. However, there is always a gravitational potential gradient acting on the Cesium (¹³³Cs) atoms of an orbiting atomic clock that cannot be cancelled by any known technical means. Thus, the escape velocity squared is shown to be a gauge for the gravitational potential gradient that is acting on the clocks. The evidence shows there is always a gravitational potential gradient that acts on the ¹³³Cs atoms of an orbiting atomic clock in much of the same manner in which the gravitational potential gradient of the moon causes the tidal effects on Earth. The findings presented here convincingly show that the gravitation does not interact directly with broadcast information or the electromagnetic waves that are transmitted from the*

⁴²⁰ <http://www.extinctionshift.com/SignificantFindings08.htm>

⁴²¹ http://www.extinctionshift.com/SignificantFindings08_B.htm

⁴²² http://www.extinctionshift.com/SignificantFindings08_C.htm

satellites bearing the atomic clocks. Observational evidence consistently shows that the gravitational phenomenon that is actually causing the slowing of the atomic clocks is directly linked to the gradient of the gravitational potential, not the gravitational potential itself.”

b.
$$\left. \frac{\partial V_E}{\partial Z} \right|_{r=R_E} = 1.6633 \cdot 10^3 \times \left. \frac{\partial V_{SUN}}{\partial Z} \right|_{r=1AU}$$

Figure 65 - Gravity gradient of Earth (MOND); credit: Dowdye

c.
$$\left. \frac{\partial V_{MOON}}{\partial Z} \right|_{r=r_{Moon}} = 2.177 \times \left. \frac{\partial V_{SUN}}{\partial Z} \right|_{r=1AU}$$

Figure 66 - Gravity gradient of Moon; credit: Dowdye

d. “This clearly explains why the atomic clocks appear to be predominantly effected by the earth’s gravitational potential gradient for distances well beyond the moon. This is well understood due to the fact that in proximity to the earth the gravitational potential of the earth gives rise to gradient lines of force that all point towards the center of the mass of Earth while those of the much more distant mass of the sun will be more parallel, less converging and consequently cause weaker or non-measurable tidal effects on the ¹³³Cs atoms of the clocks. It should be interesting to note that the tidal effect of the Moon acting on Earth is a factor of 2.177 times the tidal effect of the Sun acting on Earth. Also, note that the gravitational force of the Sun on Earth is a factor of 178.74 times the gravitational force of the Moon on Earth.

This means that, from the above calculation, the Moon has a greater tidal effect on the near Earth orbiting atomic clocks by a factor of 2.177 times that of the tidal effect of the more distant Sun.”

e. “The gravitational potential gradient introduces a deformation of the ¹³³Cs atoms, a tidal effect causing the electron configuration of the ¹³³Cs atoms to be slightly altered. The gravitational potential gradient of the Earth acting on the ¹³³Cs atoms is effectively a lengthening of the pendulum of the atomic clocks by means of a radial displacement from the unperturbed configuration of the ¹³³Cs atoms. It is this effect alone that is largely responsible for the gravitational slowing of the atomic clocks that are operating above the surface of the Earth and in near Earth orbit. The gravitational tidal effects of the Sun are at least 3 orders of magnitude less than those of the Earth.

The findings show this has nothing at all to do with Relativity.”⁴²³ (Dowdye)

Table 12 - Lensing Data Surrounding the Sun

Impact Parameter (solar radii R)	Observational History (arsec)	General Relativity (arcsec)
R	1.75	1.75
2R	< 0.875 to negligible	½ of 1.75
3R	negligible	⅓ of 1.75
nR	Not observed	1/n of 1.75

(in units of the solar radius R)⁴²⁴; credit: E Dowdye

⁴²³ Ibid.

⁴²⁴ Ibid.

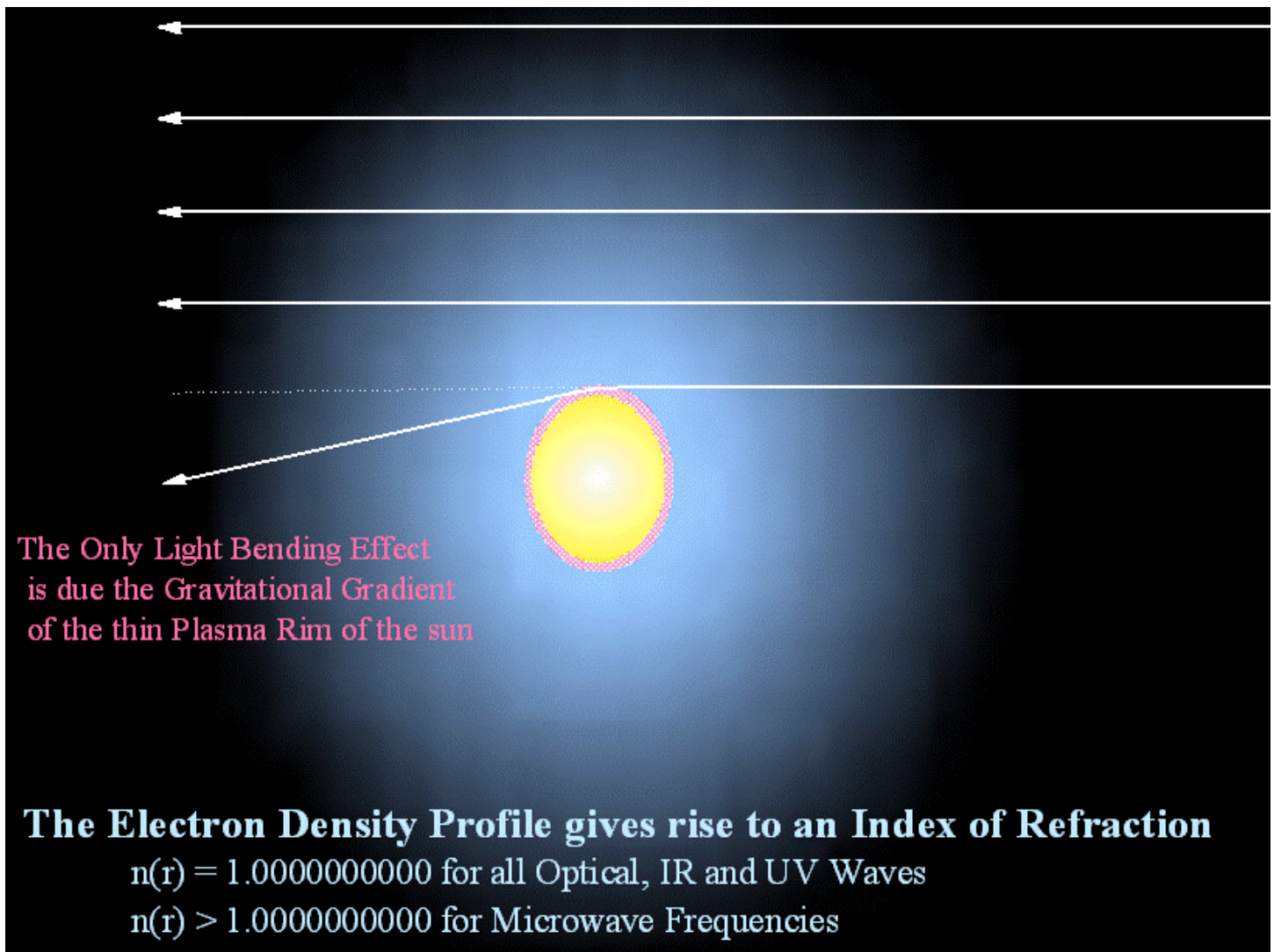

Figure 69 - Electron Density Profile predicts Refraction⁴²⁵

⁴²⁵ "Summary

The electron density profile of solar wind is found to behave very nearly as an inverse square of r , namely as r^{-2} , with electron density profile models ranging from $r^{-2.05}$ to $r^{-2.08}$, and with effects that engulf the outermost planets of the solar system. The bulk of all the Shapiro delay measurements were done using microwave frequencies from 500 MHz to 8.8GHz (with wavelengths from 80cm to 3.5cm). Significant findings of this research reveal that, for all microwave signals propagating in the solar wind atmosphere of the solar system, the waves are subjected to a frequency dependent plasma index of refraction $n(r)$ that exceeds unity, i.e., $n > 1.0000000000$. For optical, IR and UV wavelengths, the plasma index of refraction is practically $n = 1.0000000000$ and these wavelengths are virtually unaffected by the widespread atmosphere of the expanding solar wind described by the electron density profile. As a consequence, the Shapiro delay is only a very good measurement of a frequency dependent transit-time effect and can not be or have anything to do with a space-time effect of General Relativity which is independent of frequency." ~ Dowdye, Ibid.

The Ominous Rise of Dark Physics

There is a distinct difference between the search for black body planets and plasma in dark mode versus the search for [Cold] Dark Matter, Dark Energy, and black holes.

The former can be detected with known techniques here, on Earth, in lab, in space.... Everywhere. The latter cannot be detected anywhere, even using the most significant and rigorously engineered tests.⁴²⁶ It is, essentially, without any basis of evidence. As covered above, the supposed prime example of a supermassive black hole SGR A* does not behave as it should, because it neither bends light nor consumes gases that come near to it. It also, like other AGN, emits massive amounts of radioactive material, including various forms of light^{427 428}, but also ions and gases.⁴²⁹ This clearly violates the very definition of a Singularity⁴³⁰ (see last part) and a black hole in general⁴³¹. That is the end of the discussion right there.⁴³² Those single fallacies preclude those theories from having any merit and essentially send science back to the drawing board.

As mentioned, science has already uncovered its Unified Aether Field (UAF) in plasma-electromagnetism. However, for one reason or another, scientists as a whole refuse to change perspective^{433 434} (i.e., they plan to take their career intact to grave, or perhaps just need to age and their points of view forgotten). It does appear, though, that they will be turning Cold Dark Matter into Charged (Electric) Dark Matter, in their search for some semblance of reality.^{435 436}

However, CDM is a poor substitute for Birkeland Currents in a plasma-electromagnetic Universe. Chances are remote,⁴³⁷ and shrinking with every new constraint,⁴³⁸ that they will be able to find CDM that does not violate known physics,⁴³⁹ or indeed find any at all.⁴⁴⁰

As for Dark Energy, the search for it may be preemptively ended, as the rates of expansion have been called into question^{441 442} and redshift distances far overestimated.⁴⁴³

However, while CDM and Dark Energy will struggle to create conformity with measurement,⁴⁴⁴ laboratory based plasma physics has already shown galactic motion that matches observations.^{445 446 447}

The Rise of MOND

Despite the obvious viability and even natural dictum that comes with plasma and high energy physics, to find the remaining secrets of electromagnetism out and fulfill the UAF mandate, instead a strange *reversion*

⁴²⁶ <https://arxiv.org/pdf/1806.04762.pdf>

⁴²⁷ <https://arxiv.org/abs/0706.1782>

⁴²⁸ <https://arxiv.org/abs/astro-ph/0102186>

⁴²⁹ <https://www.scientificamerican.com/article/milky-way-black-hole-jet/>

⁴³⁰ Not to mention the laws of Thermodynamics <http://meetings.aps.org/Meeting/NES18/Session/D01.3>

⁴³¹ "Black" because gravity is so strong not even light can escape.

⁴³² https://www.researchgate.net/post/Hawkings_legacy_What_is_it

⁴³³ <https://arxiv.org/pdf/1804.05750.pdf>

⁴³⁴ <https://arxiv.org/pdf/1804.04132.pdf>

⁴³⁵ <https://arxiv.org/pdf/1804.01092.pdf>

⁴³⁶ <https://youtu.be/FlgmsQOKnmk>

⁴³⁷ <https://arxiv.org/pdf/1804.00088.pdf>

⁴³⁸ <https://academic.oup.com/mnras/article/476/3/3124/4875952>

⁴³⁹ <https://arxiv.org/pdf/1804.04484.pdf>

⁴⁴⁰ <https://arxiv.org/pdf/1805.11172.pdf>

⁴⁴¹ <https://futurism.com/universe-is-not-expanding-as-fast-as-it-was-previously-thought/>

⁴⁴² <https://www.sciencealert.com/no-the-universe-is-not-expanding-at-an-accelerated-rate-say-physicists>

⁴⁴³ <https://arxiv.org/pdf/1805.00908.pdf>

⁴⁴⁴ <https://sites.google.com/site/electricuniversegateway/recent-news/theuniverseearlyuniverseproblems-drmelia>

⁴⁴⁵ <https://arxiv.org/pdf/1805.04079.pdf>

⁴⁴⁶ <https://arxiv.org/pdf/1802.00081.pdf>

⁴⁴⁷ https://youtu.be/KUqV_2sj92U

has been taking place. Starting in the 1980s in response to a need for real physics to explain Universal motion, men such as Dwyer and Milgrom⁴⁴⁸ spurred along the creation of MOND - Modified Newtonian Dynamics.⁴⁴⁹ As a *current* of motion from past to present, this seems inordinately ... backwards, and stretching. In an electric age to continue to rely on Newtonian gravity, despite the progresses of relativistic and quantum mechanical worldviews, seems a bit over the top. A bit like “throwing the baby out with the bathwater.”⁴⁵⁰

Fortunately, there are actually many physicists that have doubt MOND as easily as they express doubt for CDM.^{451 452 453 454 455}

The Unfortunate Fallout of “Dark” Physics

The rise of not only MOND, SUSY, New Earth Creationism, and even “Flat Earth” (Ptolemaic) ideas among the populace is the fault of this “in the Dark physics”, which is naturally a result of the growing separation from reality caused by General Relativity and black hole “physics.” As it has become more and more acceptable to use hypothesis as actual scientific rigor, CGI artwork, pre-determined computer modeling, and simulation rather than laboratory experimentation, it is becoming clearer that Science has lost its way.

In many ways MOND is a response to this madness to try and go backwards to “set the record straight.” However, one does not have to go that far back in physics in order to find where things went sideways. In the next part, we shall visit the Quantum World, and a reality that was too weird for Newtonian mechanics (and stoggy English physicists such as Lord Kelvin). So weird in fact, it caused people to doubt the cosmological explanations of electromagnetism, rather than further invest in them⁴⁵⁶. Why should scientists at the time (circa 1910-1920) think that they understood everything about electromagnetism? It is probably the combination of several factors and fallacies:

1. The stunning revelations of [electric]-gravitic Relativity.
2. The death of Poincare - without his help to explain electrogravitics.
3. The power-threatening paradigm-shifting technologies offered by Tesla and Steinmetz.
 - a. The fall and doubt of the very sanity of Nikola Tesla, who openly expressed doubts in Relativity and Quantum weirdness.
4. The beginnings of subatomic theory and nuclear physics.
5. The sudden realization that the Universe is much bigger than not only the Solar System^{457 458}, but also the Milky Way galaxy.^{459 460 461}
6. Etc...

⁴⁴⁸ <https://youtu.be/g3xyDbPGk1M>

⁴⁴⁹ https://en.wikipedia.org/wiki/Modified_Newtonian_dynamics

⁴⁵⁰ <http://astroweb.case.edu/ssm/mond/otherlinks.html>

⁴⁵¹ <https://arxiv.org/pdf/1801.09304.pdf>

⁴⁵² <http://www.sciencemag.org/news/2017/01/can-dark-matter-vanquish-rival-theory>

⁴⁵³ <http://www.sciencemag.org/news/2011/02/more-evidence-against-dark-matter>

⁴⁵⁴ <https://www.wired.com/2017/01/case-dark-matter/>

⁴⁵⁵ <https://www.youtube.com/watch?v=CnvOybT2WwU>

⁴⁵⁶ This despite the fact that atoms and subatomic particles are completely electromagnetic in form, behavior, and charge.

⁴⁵⁷ <https://arxiv.org/pdf/1110.2445.pdf>

⁴⁵⁸ <https://cosmology.carnegiescience.edu/timeline/1920>

⁴⁵⁹ It was not that long ago, believe it or not, that professional scientists had no clue about the scale of size of the Universe. It was in fact, difficult for Edwin Hubble to make his point even in the 20th century. He had opponents in powerful positions at Harvard’s department of astronomy. Such relatively recent difficulties in paradigm shifting (taking decades) is not often discussed in early science classes at Universities, which tend still to focus on classical science history.

⁴⁶⁰ https://www.spacetelescope.org/about/history/the_man_behind_the_name/

⁴⁶¹ <https://arxiv.org/pdf/1110.2445.pdf>

III - It's a Quantum World After All

*"We are suspended in language in such a way that we cannot say what is up and what is down. The word "reality" is also a word, a word which we must learn to use correctly."*⁴⁶² ~Niels Bohr

*"We are all agreed that your theory is crazy. The question that divides us is whether it is crazy enough to have a chance of being correct."*⁴⁶³ ~Niels Bohr

Quantum Physics/Mechanics (QM) began its march towards supremacy by postulating a most disagreeable and unintuitive idea - one that defied Newtonian mechanics⁴⁶⁴: that the world was transferred via discrete values of energy (quanta), which had a fundamental, incredibly small value calculated at the Planck length to be 6.626×10^{-34} J x s.

The order is the most surprising aspect. At the time, this was a very ridiculous assertion, and not accepted at all. Famously Einstein said of QM, "God does not play dice with the Universe." In other words he, and other Relativity physicists looked at QM from 1900-1930 at around the same way that QM and other physicists looked at SUSY. The key difference being this:

Quantum Mechanics came from laboratory observation and made successful laboratory predictions.

- ❖ "Thomas Young's double-slit experiment demonstrating the wave nature of light. (c. 1805)
- ❖ Henri Becquerel discovers radioactivity. (1896)
- ❖ J. J. Thomson's cathode ray tube experiments (discovers the electron and its negative charge). (1897)
- ❖ The study of black-body radiation between 1850 and 1900, which could not be explained without quantum concepts.
- ❖ The photoelectric effect: Einstein explained this in 1905 (and later received a Nobel prize for it) using the concept of photons, particles of light with quantized energy.
- ❖ Robert Millikan's oil-drop experiment, which showed that electric charge occurs as *quanta*. (whole units) (1909)
- ❖ Ernest Rutherford's gold foil experiment disproved the plum pudding model of the atom which suggested that the mass and positive charge of the atom are almost uniformly distributed. This led to the planetary model of the atom. (1911)
- ❖ James Franck and Gustav Hertz's electron collision experiment shows that energy absorption by mercury atoms is quantized. (1914)
- ❖ Otto Stern and Walther Gerlach conduct the Stern–Gerlach experiment, which demonstrates the quantized nature of particle spin. (1920)
- ❖ Clinton Davisson and Lester Germer demonstrate the wave nature of the electron^[10] in the Electron diffraction experiment. (1927)
- ❖ Clyde L. Cowan and Frederick Reines confirm the existence of the neutrino in the neutrino experiment. (1955)
- ❖ Clauss Jönsson's double-slit experiment with electrons. (1961)" [sic]^{465 466}

⁴⁶² "Philosophy of Science Vol. 37 (1934), p. 157, and in *The Truth of Science : Physical Theories and Reality* (1997) by Roger Gerhard Newton, p. 176"

⁴⁶³ Said to Wolfgang Pauli after his presentation of Heisenberg's and Pauli's nonlinear field theory of elementary particles, at Columbia University (1958), as reported by F. J. Dyson in his paper "Innovation in Physics" (*Scientific American*, 199, No. 3, September 1958, pp. 74-82; reprinted in "JingShin Theoretical Physics Symposium in Honor of Professor Ta-You Wu," edited by Jong-Ping Hsu & Leonardo Hsu, Singapore; River Edge, NJ: World Scientific, 1998, pp. 73-90, here: p. 84). https://en.wikiquote.org/wiki/Niels_Bohr

⁴⁶⁴ Newtonian is analog, while QM is digital.

⁴⁶⁵ https://en.wikipedia.org/wiki/History_of_quantum_mechanics

⁴⁶⁶ [10] refers to <http://hyperphysics.phy-astr.gsu.edu/hbase/quantum/DavGer2.html>

$$\frac{1}{\lambda} = \frac{n}{2d \sin \theta} = \frac{p}{h} = \frac{\sqrt{2mE}}{h} = \frac{\sqrt{2meV}}{h}$$

Electron wavelength *Bragg law* *deBroglie relationship* *Acceleration through voltage V*

Figure 70 - Electron wavelength in terms of voltage and Planck's constant; credit: Hyper-Physics

Unfortunately, the weirdness of QM (from a Newtonian perspective) probably fooled the common person and new student into thinking physics was *supposed to be weird*. Certainly that was the position Niels Bohr took. He felt, as others did, that we so radically did not understand the Universe that **everything** was under question. "Anyone who is not shocked by quantum theory has not understood it."⁴⁶⁷

In point of fact this may have been the excitement of a temporary period of readjustment⁴⁶⁸. After all, not everything was wrong, it only needed further and further clarification. Quantum Electrodynamics was one such further clarification. It did, in fact, briefly unite Relativity and QM into the specific study of electromagnetism. However, it did not cover plasma, nuclear forces, Birkeland Currents, and was not able to do what was needed in astronomy, hence the creation of magnetohydrodynamics.

It wasn't that the Quantum world was truly weird or broke scientific laws and the principle of the scientific method. It was that we didn't understand some of the implicit implications within our Universe⁴⁶⁹ - the subtext, fine print, and inverses that go hand-in-hand with a truly rounded study of electromagnetism.

Although MOND maintains that the Universe holds a certain "Scale invariance," it is clear that electromagnetic behavior radically changes under these conditions:

- Voltage pressure or "tension"
- Current or flux density and intensity
- Current frequency or velocity (momentum)
- Resistivity vs Conductivity
- Permeability and Permittivity
- Charge/density (interference)⁴⁷⁰
- Field Presence or atmosphere⁴⁷¹
- Age or some time component⁴⁷²
- Scale Relativity or what the author terms as "Zoom"⁴⁷³
- Non-linearity and geometric conditions⁴⁷⁴
- Boundary conditions⁴⁷⁵
- Special cases⁴⁷⁶ or relationships

⁴⁶⁷ *Meeting the Universe Halfway* (2007) by Karen Michelle Barad, p. 254, with a footnote citing *The Philosophical Writings of Niels Bohr* (1998)

⁴⁶⁸ An early stage found in most situations with something new. Ultimately this was only the 2nd full century into the Scientific Period, and only half a century since the start of the "Age of Enlightenment." (A clear double entendre for electrically lit buildings).

⁴⁶⁹ <http://www.theomparticle.com/UnitsOfPlanck/On-Plancks-Constant-Revisited%203.pdf>

⁴⁷⁰ Water Surface Tension for example <http://article.sciencepublishinggroup.com/pdf/10.11648.j.wjap.20180301.12.pdf>

⁴⁷¹ <http://www.jpier.org/PIERM/pierm52/03.16042707.pdf>

⁴⁷² <http://bourabai.kz/articles/snt.pdf>

⁴⁷³ See Table 7 for example of Zoom as it relates to the functionary behavior of EMF at various sizes and distance scales.

⁴⁷⁴ The Fractal behavior of electromagnetic systems, such as weather vortices (tornadoes), is only starting to be understood. <https://arxiv.org/pdf/1806.04505.pdf>

⁴⁷⁵ Such as those on the ionospheric boundary as MMS found.

<https://www.nasa.gov/feature/goddard/2018/nasa-spacecraft-discovers-new-magnetic-process-in-turbulent-space>

⁴⁷⁶ Such as Van Der Waals forces in Gecko feet, or the behavior of "water bridges"

<https://www.youtube.com/watch?v=iC8KDYcdiUI>

Wave-Particle Duality

Although Lori Gardi believes that many of QM's strange predictions or weirdness may be explained by unit expansion and conversion (telling the whole story)⁴⁷⁷, the author takes the stance that the issue isn't related to math at all, but a matter of philosophy or incorrect perspective⁴⁷⁸. The questions asked before and after the Double Slit experiment seem to be the same, "Is light/electromagnetism a wave?" Yes. And "Is it a particle?" Yes. The answer to both queries being yes tells us it is, in fact, neither⁴⁷⁹.

Postulate: EMF is neither a wave nor a particle, it is a field, through which moves waves and particles.

Take the analogy of the wind⁴⁸⁰. You do not see it with your eyes (microscopes and telescopes), and yet you see the evidence of its presence, such as fluttering leaves, or bending grass. You feel it on your skin and in your hair. When powerful enough you can hear it. It can even be violent or deadly. But in reality, these are all evidences of the wind, not the wind itself. In this case, the wind represents the field *effects* of plasma-electromagnetism.

The question must be asked, "What *is* a field?" It is a relationship. One could say "of poles" or "of opposites," but the Chinese said it best when they called it yin and yang: the relationship of polar complete, opposing forces. Electricity AND Magnetism⁴⁸¹. Not one or the other, but both one and the same. The fact of the Force (Tao), creates the mutual compliments, perceived a separate by the distinguishing or discriminating consciousness. But in actuality they are one and the same Force.

Similarly, the behavior of *objects*, no matter how large or small will consequently be perceived through the lens of one "pole" or the other, depending upon the perspective. At our scale, for instance, the planets behave as giant billiard balls. But from a God-level perspective (or vast distances away) they are more like particles, and certainly the way they connect with "jets" (current), and have eddies of magnetism, they will actually move like waves (a fact the author predicts but has not come to fruition in the literature as of yet).

The deeper meaning of the Double-Slit Experiment is that we have been asking the wrong two questions all along: before and even after. To continue to ask the same question is quite the definition of insanity. The Field merely **is**. It is not one or the other of anything⁴⁸², and that is how it is whatever is needed⁴⁸³.

⁴⁷⁷ Ibid.

⁴⁷⁸ Ie - unnatural perspective

⁴⁷⁹ It is a strange logical fallacy that physics mainstream has found itself in. 0 can never be 1 and 1 can never be 0. If something is 1 and 0, they are clearly either at different times (perhaps a variable circuit), or the answer is obviously it is neither 1 nor 0.

⁴⁸⁰ The Chinese soft science of feng-shui is based upon the movement of wind and water; as it happens in Chinese medicine (zhongyi) wind is used to describe extra charge within the nerves and muscles. For more information on feng-shui see the author's work "What's My Problem?"

https://docs.google.com/document/d/1F33i6iSAws7GrCv-8kPMKqj_0en8Hh1AVdlnR5OHtI0/edit?usp=sharing

⁴⁸¹ In a strange twist of fate, now that heat is understood to be infrared radiation, which is electromagnetic, it is strange to see even still many papers which reference temperature without discussing electricity; or discuss magnetism without discussing electricity. This illustrates the fact that people still do not understand electricity, or the UAF.

⁴⁸² "The Tao that can be told is not the eternal Tao;

The name that can be named is not the eternal name.

The nameless is the beginning of heaven and earth." Tao Te Ching verse 1

⁴⁸³ "Thirty spokes are joined in the wheel's hub.

The hole in the middle makes it useful.

Mold clay into a bowl.

The empty space makes it useful.

Cut out doors and windows for the house.

The holes make it useful.

The finding of “Bose-Einstein Condensates” and “Higgs-Bosons” etc... is merely a function of perturbing the UAF (strumming on the cosmic web) and getting back the response one seeks, within the parameters which Nature allows.

Nowhere is this more evident than within Astronomy. 20 years ago, no one could find planets and there were calculations of how rare and unique the Earth is⁴⁸⁴, and nearly impossible to find life, which was extremely unlikely⁴⁸⁵. Now, they find them nearly daily, and announce the presence of organic compounds on solar system bodies such as Ceres and Mars.⁴⁸⁶

The double slit did not prove the photon - it annihilated it - and the majority of atomic physics. The mainstream just hasn't realized it yet. There are only three things, ultimately (in the mundane):

1. The Force (Tao/PEM)
2. The Field (UAF/EMF)
3. The Laws (and principles) which bind all material to all immaterial and causality⁴⁸⁷.

The interplay of these with Yin and Yang (negative and positive, respectively), combines to form the five phases of material existence within the three dimensional domain:

1. Plasma (and its five basic modes)
 - a. Dark mode
 - b. Glow Mode
 - c. High energy mode
 - d. Arc Mode
 - e. Structured Modes
 - i. Birkeland Currents
 - ii. Sheets
 - iii. Co-axials
 - iv. Dendritic/Lichtenburg
 - v. Condensates
2. Gas (and its three variations)
 - a. Ideal
 - b. Charged
 - c. Fluid/highly viscous
3. Liquids
4. Solids (crystallization and latticing)
5. Electromagnetism (and its five parts of Force division):
 - a. Electricity/radiation
 - b. Magnetism
 - c. Electrogravity
 - d. Electroweak
 - e. Nuclear (Strong)

Note that all of these have an antithetical “antimatter” state as well, naturally. Also light is not material; light is the rate of induction⁴⁸⁸ through the [Aether] medium, PEM.

*Therefore, the value comes from what is there,
But the use comes from what is not there.*” Tao Te Ching verse 11

⁴⁸⁴ http://www.astrodigital.org/astronomy/drake_equation.html

⁴⁸⁵ <https://news.harvard.edu/gazette/story/2009/05/life-in-the-universe-almost-certainly-intelligence-maybe-not/>

⁴⁸⁶ Indicating more than likely that arc discharge has been occurring, enabling the Laws of Energy and Life (Appendix B) to promote evolutionary progress.

⁴⁸⁷ Causality (karma) is almost certainly non-linear, as Quantum weirdness demonstrates.

⁴⁸⁸ K Wheeler, Ibid.

Quanta & Photoelectric Effect

The concept of the quanta was born out of experiments in the late 1800's⁴⁸⁹, when it was discovered that energy moved in discrete packets. The word is derived from quantity. In this case, the quanta was found to be incredibly much smaller than the atom and even the miniscule electron (see Table 10). What's more important, however, is that this gave people the [mistaken] perception that the quantum and nuclear worlds required something *different* than electromagnetism. Well, if you define electromagnetism as **only** relating to the movement of electrons and ions, as it was at the time, then of course it follows that this is a different matter altogether. However if you define the Force by its phenomenal characteristics, its mysterious cohesiveness, and its energetic and radiative effects, then naturally, the Quantum world becomes a mere extension of the same principle that pervades the smallest levels and the most supra galactic.

One of these mysterious effects is the famous "photoelectric effect,"⁴⁹⁰ for which Einstein received his fame in his derivations.^{491 492}

"The photoelectric effect is the emission of electrons or other free carriers when light shines on a material. According to classical electromagnetic theory, this effect can be attributed to the transfer of energy from the light to an electron. From this perspective, an alteration in the intensity of light would induce changes in the kinetic energy of the electrons emitted from the metal. Furthermore, according to this theory, a sufficiently dim light would be expected to show a time lag between the initial shining of its light and the subsequent emission of an electron. However, the experimental results did not correlate with either of the two predictions made by classical theory.

"Instead, electrons are dislodged only by the impingement of photons when those photons reach or exceed a threshold frequency (energy). Below that threshold, no electrons are emitted from the material regardless of the light intensity or the length of time of exposure to the light. (Rarely, an electron will escape by absorbing two or more quanta. However, this is extremely rare because by the time it absorbs enough quanta to escape, the electron will probably have emitted the rest of the quanta.) To make sense of the fact that light can eject electrons even if its intensity is low, Albert Einstein proposed that a beam of light is not a wave propagating through space, but rather a collection of discrete wave packets (photons), each with energy $h\nu$. This shed light on Max Planck's previous discovery of the Planck relation ($E = h\nu$) linking energy (E) and frequency (ν) as arising from quantization of energy. The factor h is known as the Planck constant."⁴⁹³

There is no issue with this explanation, technically, however it is incredibly misleading to suggest (in the light of the double-slit experiment) that the wave model is necessarily incorrect. In fact this seems quite a large leap based on the information we now know.

"According to Maxwell's theory, energy is to be considered as a continuous spatial function for all purely electromagnetic phenomena, hence also for light, while according to the current conceptions of physicists the energy of a ponderable body is to be described as a sum extending over the atoms and electrons. The energy of a ponderable body cannot be broken up into arbitrarily many, arbitrarily

⁴⁸⁹ "Much of the physics establishment did not share his belief in the reality of atoms and molecules — a belief shared, however, by Maxwell in Scotland and Gibbs in the United States; and by most chemists since the discoveries of John Dalton in 1808. He had a long-running dispute with the editor of the preeminent German physics journal of his day, who refused to let Boltzmann refer to atoms and molecules as anything other than convenient theoretical constructs." https://en.wikipedia.org/wiki/Ludwig_Boltzmann#Physics

⁴⁹⁰ https://en.wikipedia.org/wiki/Photoelectric_effect

⁴⁹¹ <https://einsteinpapers.press.princeton.edu/vol2-trans/100>

⁴⁹² <https://arxiv.org/pdf/physics/0701240.pdf>

⁴⁹³ Ibid.

small parts, while according to Maxwell's theory (or, more generally, according to any wave theory) the energy of a light ray emitted from a point source of light spreads continuously over a steadily increasing volume.

The wave theory of light, which operates with continuous spatial functions, has proved itself splendidly in describing purely optical phenomena and will probably never be replaced by another theory. One should keep in mind, however, that optical observations apply to time averages and not to momentary values, and it is conceivable that despite the complete confirmation of the theories of diffraction, reflection, refraction, dispersion, etc., by experiment, the theory of light, which operates with continuous spatial functions, may lead to contradictions with experience when it is applied to the phenomena of production and transformation of light.”⁴⁹⁴ ~Einstein

This is a reasonable statement, but is itself, a contradiction of experience. If the wave theory of light is very successful, to disregard it in preference of another, ie the packet (essentially a particle) without finding a way to augment or understand the currently successful paradigm is a bit premature. It is all too curious why this was allowed to stand, for even on face value, it seems a bit of a leap.

However, the fact remains that these discrete energy packets which rely upon Planck's constant and the wavelength of light is an incredibly useful and accurate model. Realistically though, it is quite another thing to propose that light is - seriously - a particle of 0 mass. This is about as realistic as creating infinite masses of 0 radius!⁴⁹⁵

Rather the author would like to propose a thought experiment to essentially debunk the particle theory. If a small, spherical particle light source is provided in a small room, one will naturally expect bright, and even luminescence upon its walls. However, if one were to enlarge the room, though the brightness density may decrease, it will remain even, and not splotched. It will not “splash” or gather in concentrations, it will remain (if there are no obstructions) evenly distributed.

This demonstrates a wavelike behavior, and only a wave. In particular, it demonstrates a ubiquitous field that is being disturbed in a ubiquitous manner.

This also appears to be supported by the black body radiation⁴⁹⁶ experiments of Robitaille which demonstrate the patent falseness of Kirchhoff's Law⁴⁹⁷ (itself an extension of the thermo-photovoltaic effect⁴⁹⁸). All of these mysteries are, of course, actually interrelated phenomena. Later, in the section on Structured Atoms, the author will propose a hypothetical reason why carbon (and water at times) performs as a black body. For now, it will be merely proposed that the UAF=EMF=PEM, and in fact the photon or quantum packet, whatever it is represents is a “bit” of communication, and is not a particle in the same sense. It is not a composition of quarks, but rather is an inductive⁴⁹⁹ message of energy. Its function is not billiard/mechanical in behavior, but in communication.

That requires us to ask, “Why then does EMF behave as a particle, especially in plasma form?”⁵⁰⁰ ⁵⁰¹ Perhaps it carries the information induced into the particles of delivery? After all, there is no way for us to observe the behavior without observing particles or atoms, and without observing them *with* particles and atoms, and understanding them *through* our own particles and atoms. So much for eliminating observational bias.

⁴⁹⁴ Ibid.

⁴⁹⁵ See previous section on Crothers

⁴⁹⁶ https://en.wikipedia.org/wiki/Black-body_radiation

⁴⁹⁷ See previous section on Robitaille

⁴⁹⁸ https://en.wikipedia.org/wiki/Photovoltaic_effect

⁴⁹⁹ Induction implies storage of current, and hysteresis.

⁵⁰⁰ https://www.plasma-universe.com/Electric_currents_in_space_plasmas

⁵⁰¹ <https://journals.aps.org/prl/abstract/10.1103/PhysRevLett.95.045002>

Proof via Laser Application and Quantum Tunneling Circuitry

One of the best proofs of a theory is via practical application. One of the best proofs of the quanta/photon model in use is lasers⁵⁰². In order to produce laser⁵⁰³ light, electrons are first stimulated to raise to a calculable high energy state, at which time when they then release the energy (as light), it will have specific planck length frequency, all uniform⁵⁰⁴. See Figure 71

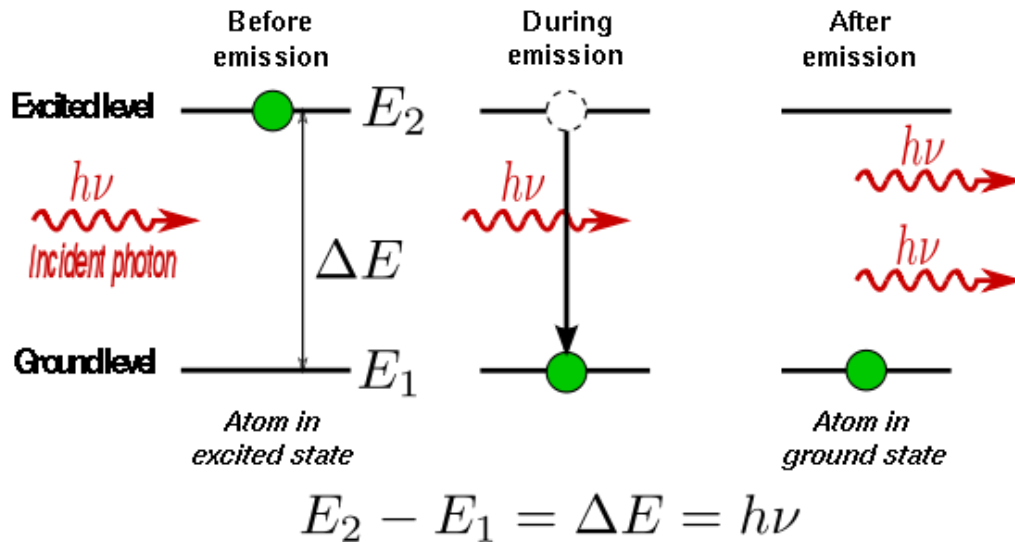

Figure 71 - Laser release (series of steps left to right); credit: Wikipedia

Notice, however, three things. The first is the use of the photovoltaic effect. Secondly, that there is a pre-defined EMF (radiative) reaction to the electron, which of course is electromagnetic. Thirdly, that the process is repeatable *ad infinitum*, and that the system is not drained by this behavior. This proves, in essence, that EM is the aether; it is self-sustained. It does not degrade, and the orbital levels are totally predictable. They rely upon a *solid behavior*, which is an inherent property of the material, and of atoms, and electrons and light.

All of these are mutually intrinsic properties of a similar structure that is self-organized in a coherent and repeatedly predictable system. This type of internal consistency reveals an underlying matrix field, which is the UAF in mathematical form.

It very well may be that classical electromagnetism will not describe this behavior at all. However, the reason that quarks and subatomic particles are measured in electron volts is precisely one fact: mass is determined via **charge**. And charge (Q) density is related, therefore, to inertia. Why? Because the denser the charge (weight), the stronger the resistance to movement in the PEM which is the Unified Aether Field. The Field is inherent in the system.

An analogy would be the IP addresses in the internet⁵⁰⁵. Without IP and other protocol addresses, there would be no internet. The internet IS the interrelationship of these addresses. More importantly, the IP addresses are inherently related to the physical and virtual addresses in the natural surface of the Earth. Without a physical location, there is no IP, and therefore no internet. To add one more layer, the World Wide Web is the relationship of these things (and the servers they rely upon), and without them there is no WWW.

⁵⁰²

https://www.springer.com/cda/content/document/cda_downloaddocument/9783319051277-c1.pdf?SGWID=0-0-45-1448603-p176584453

⁵⁰³ Light Application by Stimulated Emission of Radiation

⁵⁰⁴ http://www.iop.org/cs/page_43644.html

⁵⁰⁵ Internet Protocol https://en.wikipedia.org/wiki/Internet_Protocol

It is unclear to the author why Science and mainstream physics feels a need to continuously disconnect the various parts of atomic physics from each other⁵⁰⁶, however, such an act makes as much sense as breaking apart the words of the sentence asking, “Where are the letters and what is the sentence, and what does it mean?” It’s a recursive problem, and has no reductive or deductive solution. The only way to analyze the question is to include the whole of the sentence to invoke it to answer the question itself. Such is the issue of studying Quantum Mechanics.

A second proof of QM in practical use is in steady state memory and semiconductors⁵⁰⁷ in general. Without being too complicated, the concept of quantum tunneling⁵⁰⁸ is invoked to determine how much voltage will induce not only a current in a dielectric material⁵⁰⁹, but at some certain point induce a semi-permanent state change of the atomic structure to maintain the desired “bit” status (1 or 0) even without being under power.⁵¹⁰

Quantum Weirdness

“Spooky Action at a Distance,” aka Quantum Entanglement, was the subject of much adversity and conflict between GR physicists and QM physicists, for over 80 years⁵¹¹. Even today, despite being proven conclusively in 2017⁵¹², GR theorists attempt to co-opt the discussion⁵¹³. They describe how spin information which travels much faster than the speed of light⁵¹⁴, somehow does not violate the cosmic speed limit: *c*. Of course, the simple answer is that the supposed speed limit *will only apply* to charge dense material (3-dimensional), and not to any 4th dimension, such as time (if it be a dimension at all), or quality, inherence, inheritance, principle, property (isness), meaning, true thought, etc... Another is that there is no speed limit or that *c* is not constant. The author makes no claims in the latter, but agrees with the former.

A full discussion of Quantum Weirdness is beyond the scope of this paper. Whether or not it is truly weird, or common sense application of the concept of Polar Completeness⁵¹⁵, which is one of the 4th dimensional properties of the UAF (EMF and PEM), is up for debate. But the fact remains that QM was even successful at this.

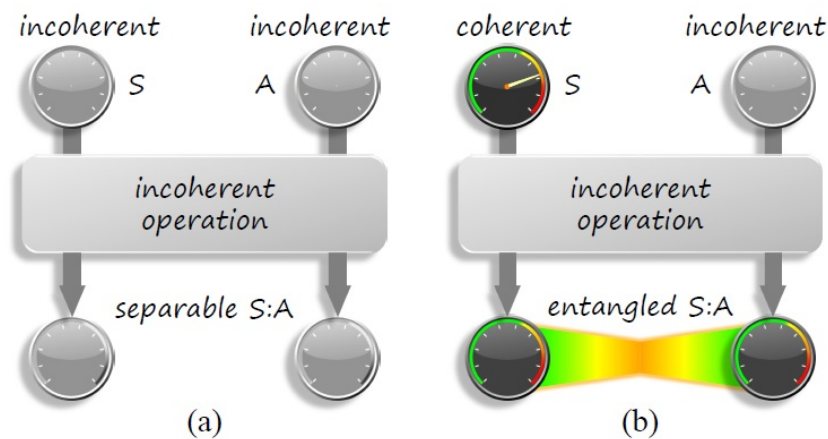

Figure 72 - Quantum Entanglement; credit: phys.org⁵¹⁶

⁵⁰⁶ Thereby missing the Forest for the trees. Note that forest is almost a homophone for force.

⁵⁰⁷ <https://en.wikipedia.org/wiki/Semiconductor>

⁵⁰⁸ https://en.wikipedia.org/wiki/Quantum_tunnelling

⁵⁰⁹ <https://en.wikipedia.org/wiki/Dielectric>

⁵¹⁰ Such is why steady state hard drives can help computers boot much faster than typical magnetic Hard Disk Drives.

⁵¹¹ <https://arstechnica.com/science/2012/01/experiment-shows-speed-limit-for-interactions-in-quantum-systems/>

⁵¹² <https://futurism.com/this-discovery-could-transform-our-understanding-of-the-cosmos/>

⁵¹³ <https://www.sciencenews.org/blog/context/entanglement-spooky-not-action-distance>

⁵¹⁴ Ie - instantly; <https://newatlas.com/quantum-entanglement-speed-10000-faster-light/26587/>

⁵¹⁵ “Stone Monkey; An Alternative, Chinese-Scientific, Reality” by Bruce Holbrook

⁵¹⁶ <https://phys.org/news/2015-06-physicists-quantum-coherence-entanglement-sides.html>

Quantum Electrodynamics

Quantum Electrodynamics, by contrast to the above topic, was an attempt to provide relativistic quantum mechanics towards small scale electrodynamics (versus electrostatics). It was the genius of Feynman, whose lectures are still available on YouTube and on the internet.

QED has been successful in describing 3-dimensional magnetic behavior with 1 dimensional electrical movement, of various surface shapes, in multiple dimensional spaces. This has been useful in the creation of the field of signals communications (telecommunications), describing (to a degree) superconductivity, field perturbations, magnetic moments, Hydrogen behaviors, etc...

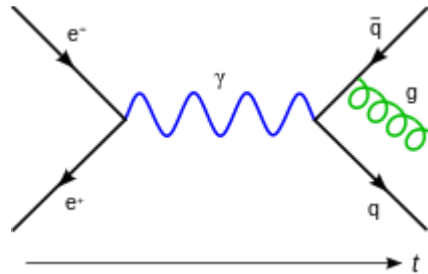

Figure 73 - Feynman Diagram; credit: Wikipedia

“Near the end of his life, Richard P. Feynman gave a series of lectures on QED intended for the lay public. These lectures were transcribed and published as Feynman (1985), QED: The strange theory of light and matter, a classic non-mathematical exposition of QED from the point of view articulated below.

The key components of Feynman's presentation of QED are three basic actions.

- 1. A photon goes from one place and time to another place and time.*
- 2. An electron goes from one place and time to another place and time.*
- 3. An electron emits or absorbs a photon at a certain place and time...*

These actions are represented in the form of visual shorthand by the three basic elements of Feynman diagrams: a wavy line for the photon, a straight line for the electron and a junction of two straight lines and a wavy one for a vertex representing emission or absorption of a photon by an electron. These can all be seen in the adjacent diagram.

*It is important not to over-interpret these diagrams. **Nothing is implied about how a particle gets from one point to another.** The diagrams do not imply that the particles are moving in straight or curved lines. They do not imply that the particles are moving with constant speeds. The fact that the photon is often represented, by convention, by a wavy line and not a straight one does not imply that it is thought that it is more wavelike than is an electron. The images are just symbols to represent the actions above: photons and electrons do, somehow, move from point to point and electrons, somehow, emit and absorb photons. The theory does not explain how these things happen, but it does tell us the probabilities of these things happening in various situations.*

As well as the visual shorthand for the actions Feynman introduces another kind of shorthand for the numerical quantities called probability amplitudes⁵¹⁷. The probability is the square of the absolute value of total probability amplitude, $P=|f(A)|^2$. The quantity that tells us about the probability amplitude for the emission or absorption of a photon he calls j . This is related to, but not the same as, the measured electron charge e .⁵¹⁸ [emphasis added]

⁵¹⁷ https://en.wikipedia.org/wiki/Quantum_electrodynamics#Probability_amplitudes

⁵¹⁸ https://en.wikipedia.org/wiki/Quantum_electrodynamics

The author would like to point out that the model is very accurate because it is ambiguous - because it is describing **field** behavior, of waves in the luminous “aether” of electromagnetism, and **not** particle mechanics.

IV - The Magnetic Universe

Our Magnetic Universe is not really in dispute. In the following sections the author will discuss first standard magnetics that have surpassed classical magnetism, and then talk about more (in addition to Distinti's New Magnetism) alternative theories, particularly as they relate to gravitics. Following that, in the last part will be an Electric Rebuttal. Criticisms by the author will conclude each section. Bear in mind, that the premise thus far has been in support of a Unified Aether Field (or Unified Field) based around Plasma Electromagnetism as a singular mechanism. However, in this part, a case is made by several practicable men for everything being actually simply Magnetism. Something which Distinti also has said, may be a possibility (that electricity is really magnetism or magnetism's shadow).⁵¹⁹

Quantum Magnetism

Nobody actually knows what is happening inside the atom. Though the standard atomic model (AM) has evolved (see Figure 74) the reality is that we have never seen beneath the outer surface of atoms and molecules. See Figure 75.

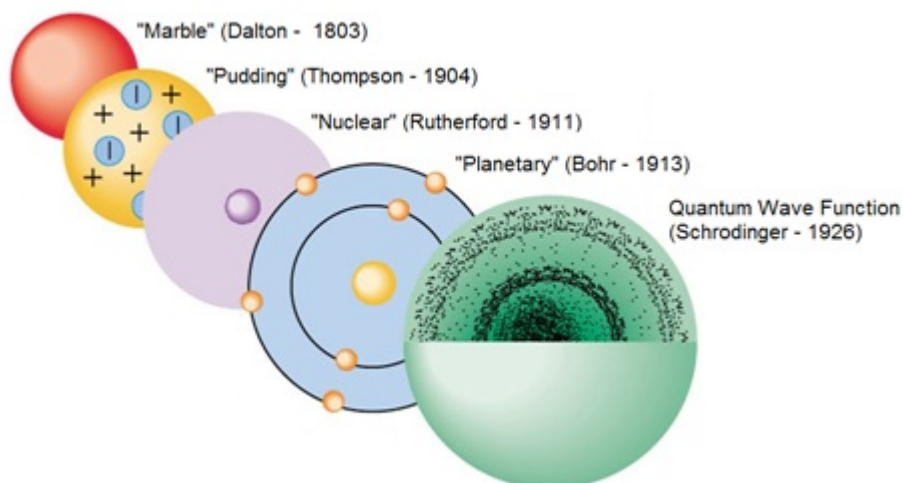

Figure 74 - Evolving Atomic Model; note it hasn't continued to evolve

There are strong reasons to suspect that neutrons are actually just microorbiting (hence Strong Force, see Table 13) protons and electrons. A molecule within the nucleus; which also makes sense from a self-organizational approach. This would explain, for example, why it is very difficult to keep two neutrons inside of a Hydrogen atom (creating Tritium), whereas it is not at all difficult to keep one (Deuterium). There are simply: too many protons.

The ramifications of this concept cannot be overstated. First of all our current Periodic Table (Figure 76), with its bizarre 2 dimensional framework, would become obsolete. In fact, the entire thing could be said to be misleading or at best: only part of the story of elemental “families” or “groups”... since the relationship between isotopic behaviors of disparate elements and families is not entirely understood. In fact, the more one looks into isotopes, the more it becomes clear that the same “element” having two isotopes (one useful, one

⁵¹⁹ Ibid.

toxic, for example) is really more like two separate elements that happen to overlap in *some* respects⁵²⁰. See Figure 77.

Table 13 - Comparison of Force Scales

Attractive Force	Scale Relative to Strong ⁵²¹	Relative to EMF	Fundamental “particle”
Gravity	10^{-41}	10^{-36}	graviton
Electromagnetism	10^{-3}	1	photon
Electroweak	10^{-16}	10^{-7}	electron, bosons W & Z
Strong	1	102x	gluon

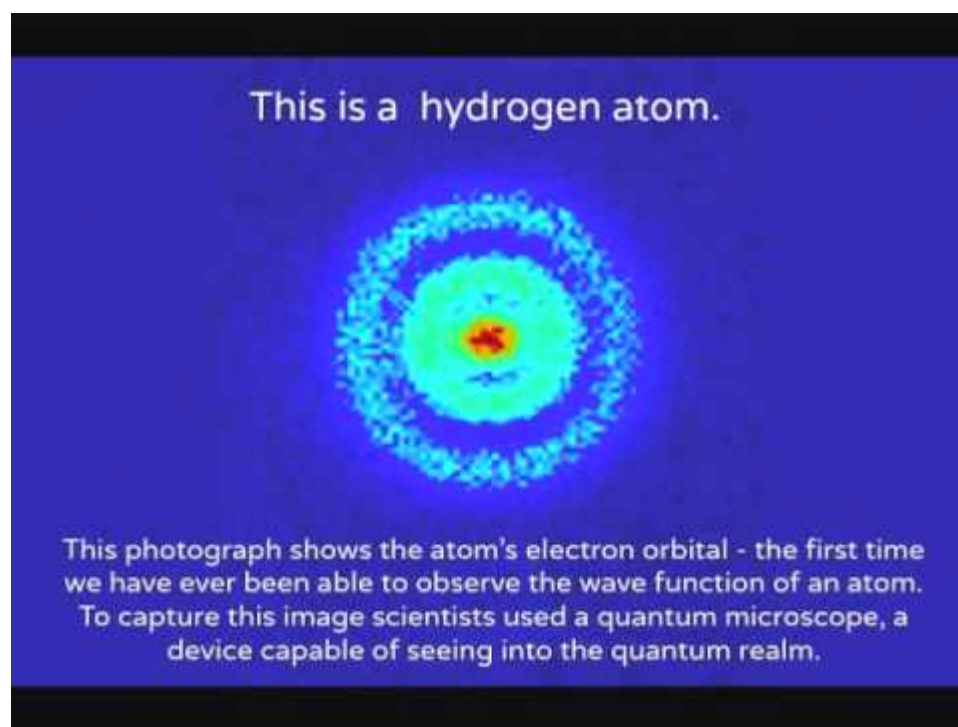

Figure 75 - Inside Hydrogen atom is more than expected; credit: Gizmodo⁵²²

Then there is the difference in behavior created by ions (different numbers of electrons than the neutral version)⁵²³. Then there are cases of molecules with highly varying molecular geometries which drastically alter

⁵²⁰ Same chemical properties, but sometimes radically different physical properties.

⁵²¹ <https://socratic.org/questions/how-do-different-isotopes-of-the-same-element-compare>

⁵²² <https://sureshemre.wordpress.com/2013/12/14/why-is-gravity-so-different-from-other-forces/>

⁵²³ <https://io9.gizmodo.com/the-first-image-ever-of-a-hydrogen-atoms-orbital-struct-509684901>

⁵²³ To say nothing of isomers, allotropes, and isobars!

functionality. The entire concept of orbital shells or “spins” - especially in quarks - is incredibly questionable⁵²⁴, although it is quite useful in predictive materials engineering (but not entirely so⁵²⁵).

Periodic Table of Elements

1	2	3	4	5	6	7	8	9	10	11	12	13	14	15	16	17	18
1 H Hydrogen 1.00784	2 He Helium 4.002602																
3 Li Lithium 6.941	4 Be Beryllium 9.012182																
11 Na Sodium 22.98976928	12 Mg Magnesium 24.3050																
19 K Potassium 39.0983	20 Ca Calcium 40.078	21 Sc Scandium 44.955912	22 Ti Titanium 47.867	23 V Vanadium 50.9415	24 Cr Chromium 51.9961	25 Mn Manganese 54.938045	26 Fe Iron 55.845	27 Co Cobalt 58.933195	28 Ni Nickel 58.6934	29 Cu Copper 63.546	30 Zn Zinc 65.38	31 Ga Gallium 69.723	32 Ge Germanium 72.64	33 As Arsenic 74.92160	34 Se Selenium 78.96	35 Br Bromine 79.904	36 Kr Krypton 83.798
37 Rb Rubidium 85.4678	38 Sr Strontium 87.62	39 Y Yttrium 88.90585	40 Zr Zirconium 91.224	41 Nb Niobium 92.90638	42 Mo Molybdenum 95.96	43 Tc Technetium (97.9072)	44 Ru Ruthenium 101.07	45 Rh Rhodium 102.90550	46 Pd Palladium 106.42	47 Ag Silver 107.8682	48 Cd Cadmium 112.411	49 In Indium 114.818	50 Sn Tin 118.710	51 Sb Antimony 121.760	52 Te Tellurium 127.60	53 I Iodine 126.90447	54 Xe Xenon 131.293
55 Cs Caesium 132.9054519	56 Ba Barium 137.327	57-71 Lanthanoids	72 Hf Hafnium 178.49	73 Ta Tantalum 180.94788	74 W Tungsten 183.84	75 Re Rhenium 186.207	76 Os Osmium 190.23	77 Ir Iridium 192.217	78 Pt Platinum 195.084	79 Au Gold 196.966569	80 Hg Mercury 200.59	81 Tl Thallium 204.3833	82 Pb Lead 207.2	83 Bi Bismuth 208.98040	84 Po Polonium (208.9824)	85 At Astatine (209.9871)	86 Rn Radon (222.0176)
87 Fr Francium (223)	88 Ra Radium (226)	89-103 Actinoids	104 Rf Rutherfordium (261)	105 Db Dubnium (262)	106 Sg Seaborgium (266)	107 Bh Bohrium (264)	108 Hs Hassium (277)	109 Mt Meitnerium (268)	110 Ds Darmstadtium (271)	111 Rg Roentgenium (272)	112 Uub Ununbium (285)	113 Uut Ununtrium (284)	114 Uuq Ununquadium (289)	115 Uup Ununpentium (288)	116 Uuh Ununhexium (292)	117 Uus Ununseptium	118 Uuo Ununoctium (294)

For elements with no stable isotopes, the mass number of the isotope with the longest half-life is in parentheses.

Design and Interface Copyright © 1997 Michael Dayah (michael@dayah.com). <http://www.ptable.com/>

57 La Lanthanum 138.9047	58 Ce Cerium 140.116	59 Pr Praseodymium 140.90765	60 Nd Neodymium 144.242	61 Pm Promethium (145)	62 Sm Samarium 150.36	63 Eu Europium 151.964	64 Gd Gadolinium 157.25	65 Tb Terbium 158.92535	66 Dy Dysprosium 162.500	67 Ho Holmium 164.93032	68 Er Erbium 167.259	69 Tm Thulium 168.93421	70 Yb Ytterbium 173.054	71 Lu Lutetium 174.9668
89 Ac Actinium (227)	90 Th Thorium 232.03806	91 Pa Protactinium 231.03688	92 U Uranium 238.02891	93 Np Neptunium (237)	94 Pu Plutonium (244)	95 Am Americium (243)	96 Cm Curium (247)	97 Bk Berkelium (247)	98 Cf Californium (251)	99 Es Einsteinium (252)	100 Fm Fermium (257)	101 Md Mendelevium (258)	102 No Nobelium (259)	103 Lr Lawrencium (262)

Figure 76 - Standard Periodic Table of Elements (SPTE); credit: P-table⁵²⁶

⁵²⁴ In terms of angular momentum, preservation of energy, supplying an external force to explain behavior, etc...

⁵²⁵ Although chemistry does make a few predictive claims, frequently the full effects of a new chemical are not known until synthesized and analyzed.

⁵²⁶ <https://www.ptable.com/>

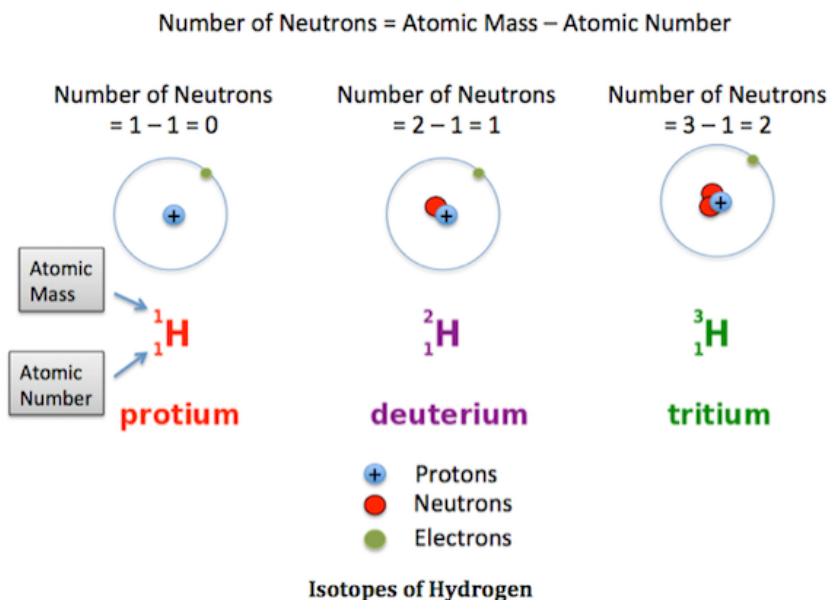

Figure 77 - Hydrogen isotopes⁵²⁷; credit: Study.com

The quantum behavior of subatomic particles has been the subject of intense scrutiny and exploration for the last 80 years, since the beginning of the nuclear age⁵²⁸. Particle accelerators are used to smash and collapse atoms and particles in magnetic force field chambers⁵²⁹, and then the explosive and strange behaviors are recorded and analyzed for “spin” characteristics⁵³⁰. Quark behavior is still evolving.⁵³¹

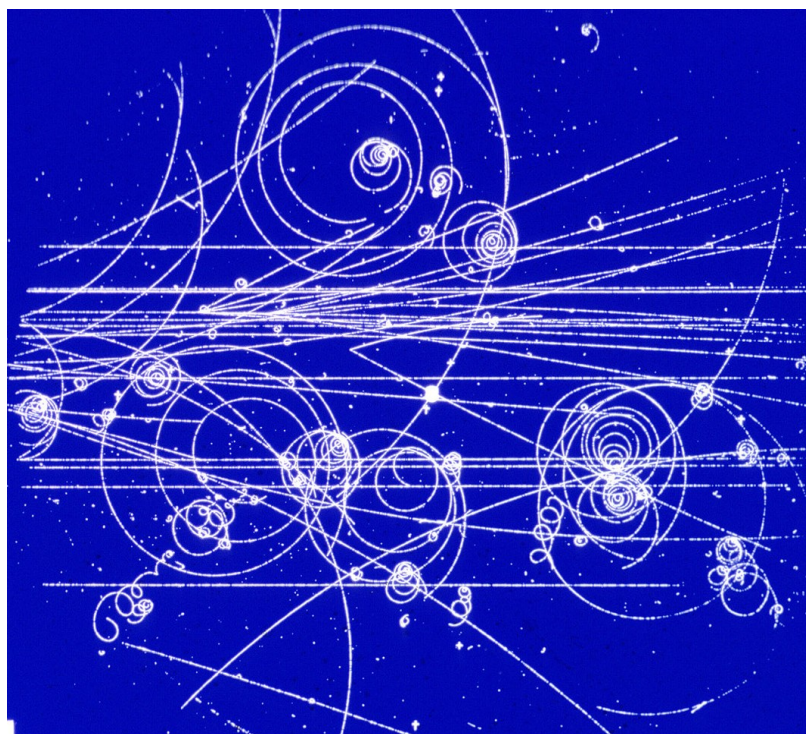

Figure 78 - An old school Atom Smashing

⁵²⁷ In the SAM section of the paper, we will revisit these isotopes using the neutron model discussed above

⁵²⁸ <http://www.atomicconfluence.com/?cat=21>

⁵²⁹ https://www.lhc-closer.es/taking_a_closer_look_at_lhc/0.magnetic_dipoles

⁵³⁰ <https://science.howstuffworks.com/how-track-particles-lhc.htm>

⁵³¹ <https://www.newscientist.com/article/dn3687-new-sub-atomic-particle-confounds-theory/>

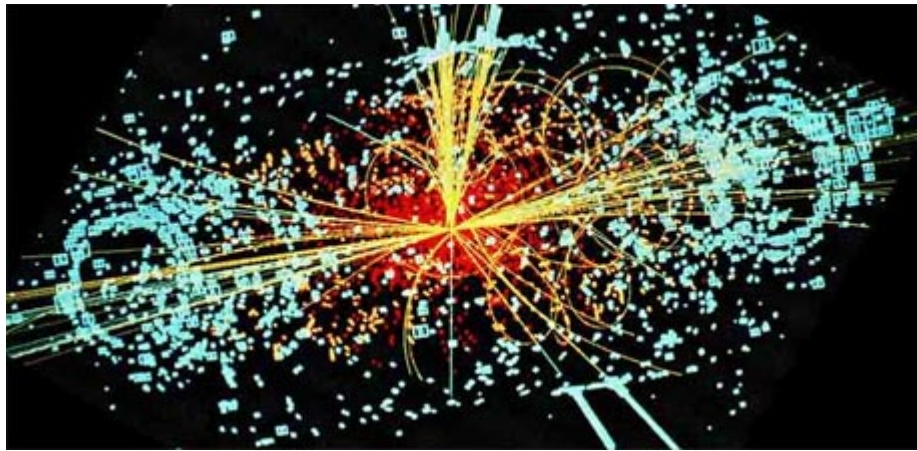

Figure 79 - Higgs-Boson search at LHC; credit: CERN

But in all that time, though we have found an entire zoo of new particles (and one man has predicted there to be 256 based on slices through a torus⁵³²) and anti-particles⁵³³: In the end we create these events with electromagnetics, view them with electromagnetics, and measure them with electromagnetics, and create “weights” in electronVolts⁵³⁴.

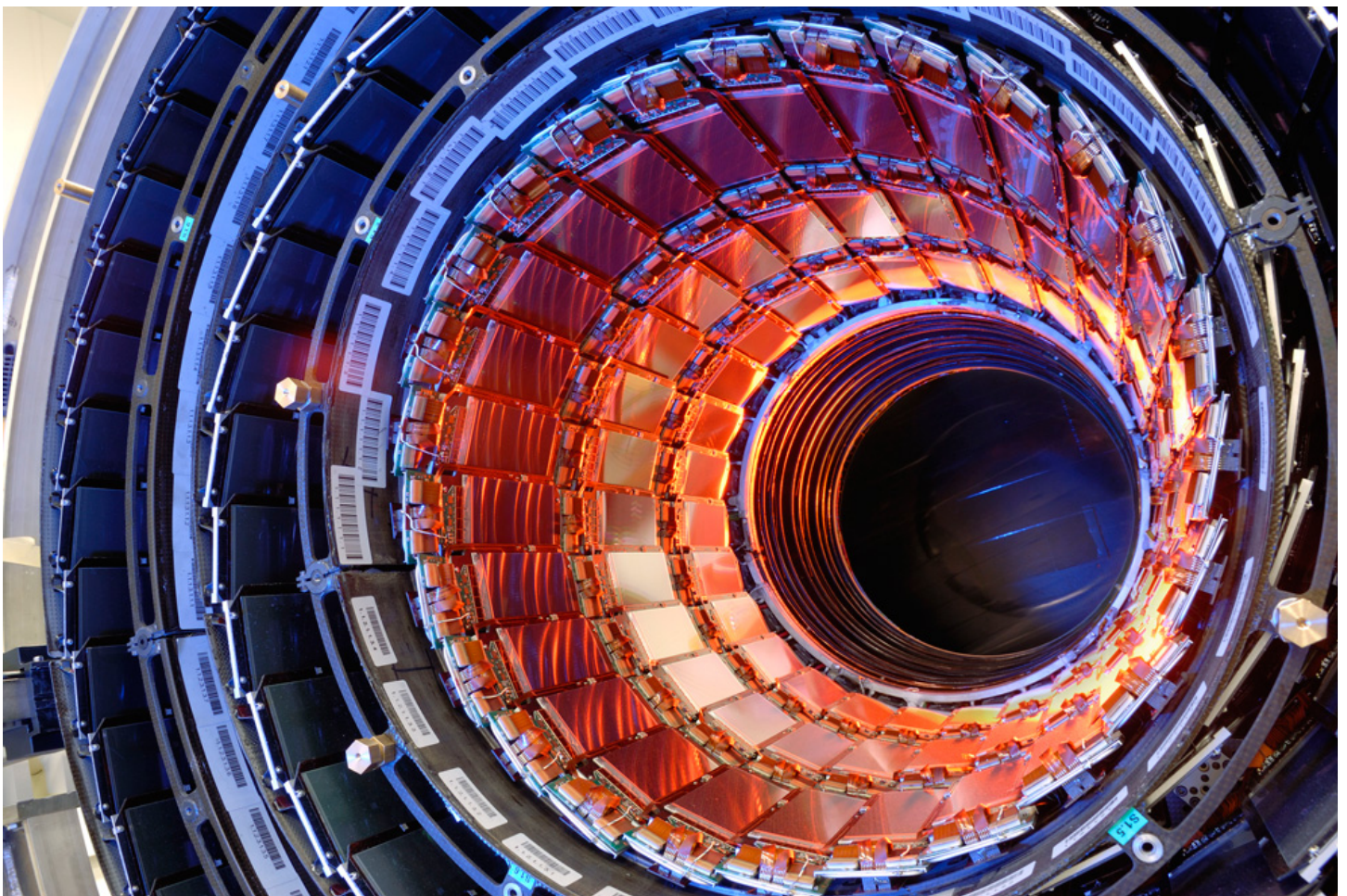

Figure 80 - Large Hadron Collider core; credit: Wired

⁵³² <http://phoenix.ps.uci.edu/zlin/bib/holod08.pdf>

⁵³³ <https://www.popularmechanics.com/science/a27049/in-1928-one-physicist-accidentally-predicted-antimatter/>

⁵³⁴ <http://science.sciencemag.org/content/256/5061/1287?ck=nck>

Alfven's Magnetohydrodynamics

This is, perhaps, a good point to interject one of the most iconic leaps in magnetic theory, post Feynman, and right around the same time as the quark revolution (if quarks exist, which strong evidence shows they do).

The story of Hannes Alfven's creation of MHD, and subsequent lamblasting of it in his 1970 Nobel Prize speech, is recounted in the PEM paper⁵³⁵. Here we need to discuss the actual physical understanding of MHD, sans electricity.

"The fundamental concept behind MHD is that magnetic fields can induce currents in a moving conductive fluid, which in turn polarizes the fluid and reciprocally changes the magnetic field itself. The set of equations that describe MHD are a combination of the Navier–Stokes equations of fluid dynamics and Maxwell's equations of electromagnetism. These differential equations must be solved simultaneously, either analytically or numerically."⁵³⁶

In other words, various forms of curl and flux equations.

The value of MHD has been to help model and explain various astronomical and microdynamical behaviors of polarized particles (including plasmas). It has led to fascinating magnetic flux rope models in our solar system, galaxy, and beyond into the Universe. Indeed, it has helped to till the Void, so to speak, as to interactive behaviors of the Magnetic Universe. It has, in effect, single handedly kept the gravity-hawks from claiming the ultimate supremacy of the weakest attractive force we know of, and has continuously reminded astrophysicists of the interconnectedness, and twisting/coiling/non-linear behavior of magnetism in space (and therefore of the solar and stellar winds.)

Where MHD has succeeded, it has open new avenues of discourse surrounding (what are termed at this time, incorrectly as) black holes, Active Galactic Nuclei, quasars, pulsars, and many other features. Again, the author would refer the reader to the PEM paper for magnificent models and figures showing some of these behaviors. Or see Figures 28 and 30 previously.

Recently, in May of 2018, it was announced that MMS had mapped MHD "eddy" current structures just outside the plasmasphere of the Earth, which has further reinforced the model.

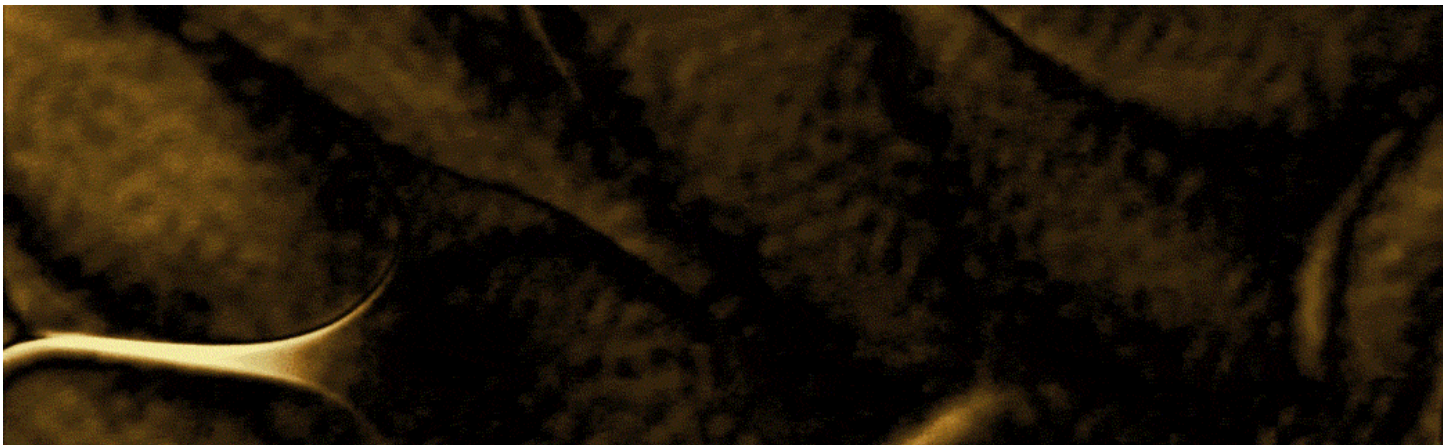

Figure 81 - MMS currents in space (open in web view for movement); credit: NASA⁵³⁷
The failings of the model are, however, three-fold.

⁵³⁵ [4]

⁵³⁶ <https://en.wikipedia.org/wiki/Magnetohydrodynamics>

⁵³⁷ <https://www.nasa.gov/feature/goddard/2018/nasa-spacecraft-discovers-new-magnetic-process-in-turbulent-space>

- The author has demonstrated with a simple experiment⁵³⁸ that there is no such thing as “magnetic reconnection”⁵³⁹; See Donald Scott.⁵⁴⁰
- There are no “frozen in fields”⁵⁴¹ in magnetism, it is always roiling and coiling; Alfven agreed.⁵⁴²
- You cannot have magnetism without either electric current, or an electric field.^{543 544}
 - ◆ If you wish to make electricity into shadow-magnetism, it still must be modelled.

The difficulties posed by incorporating QED⁵⁴⁵ with MHD are not to be taken lightly⁵⁴⁶, and considering that QED is electrical in one direction, it poses an even stiffer challenge to model plasmas and current sheets⁵⁴⁷ in situ. Even starting one of the most difficult aspects is deciding on and creating a matrix cross product, which produces a field of vectors⁵⁴⁸ in the orthogonal direction⁵⁴⁹. Then there is the issue posed by Distinti’s Vortrix Algebra: is there a 4th dimensional “volume” component Axyz?

“The volume dimension would be defined as dimension xyz and the vector would be written arithmetically as $A=A_x+A_y+A_z+A_{xyz}$ ”⁵⁵⁰ ~Distinti

	3	x	3	GOOD	3	x	3
A	1	2	3	B	8	7	6
	4	5	6		5	4	3
	7	8	1		2	1	9
	C (from above)				E (dot/cross/div products)		
	-11x+22y+-11z	-10x+20y+-10z	9x+9y+-9z		-11x+22y+-11z+1xyz	-10x+20y+-10z+2xyz	9x+9y+-9z+3xyz
	-20x+40y+-20z	-19x+38y+-19z	27x+0y+-18z		-20x+40y+-20z+4xyz	-19x+38y+-19z+5xyz	27x+0y+-18z+6xyz
	11x+-6y+-29z	4x+0y+-28z	69x+-57y+-27z		11x+-6y+-29z+7xyz	4x+0y+-28z+8xyz	69x+-57y+-27z+1xyz

Figure 82 - AxB: 3D array of vectors and with 4th dimensional Volume component; credit: author

Nevertheless, the discovery of Alfven waves and the Alfven length⁵⁵¹ requires a squaring up of Birkeland currents and Alfven’s magnetohydrodynamics in plasma physics⁵⁵². The author offers no concrete solutions, but would reiterate that it will likely be necessary to utilize New Electromagnetism in order to eliminate the errors in Maxwell-Heaviside, first, and then proceed from there.

⁵³⁸ <https://www.youtube.com/watch?v=ZPYEsigZUgU>

⁵³⁹ <https://arxiv.org/pdf/1711.11284.pdf>

⁵⁴⁰ www.youtube.com/watch?v=ILUmJmDi6uM

⁵⁴¹ <http://adsabs.harvard.edu/full/1978Ap%26SS..56....3S>

⁵⁴² https://www.nobelprize.org/nobel_prizes/physics/laureates/1970/alfven-lecture.pdf

⁵⁴³ Definition of magnetism, see Appendix A and B.IV

⁵⁴⁴ *“Alfvén was the first to predict (in 1963) the large-scale filamentary structure of the universe, a discovery that confounded astrophysicists in 1991 and added to the woes of Big Bang cosmology. Hannes Alfvén has played a central role in the development of several modern fields of physics, including plasma physics, the physics of charged particle beams, and interplanetary and magnetospheric physics.*

Twenty years before the discovery of the Van Allen radiation belt, Alfvén developed the basic tools we use today to describe it. He proposed a mechanism explaining the acceleration of cosmic rays that is now known as the Fermi Mechanism. Alfvén did it before Fermi. And he fought for years to make astronomers aware of the existence and importance of electric fields and currents in space.” ~Electric Sky, by Donald Scott

⁵⁴⁵ <http://fy.chalmers.se/~f3ail/Publications/Jakobsberg.pdf>

⁵⁴⁶ <https://www.sciencedirect.com/science/article/pii/S0370269301009868>

⁵⁴⁷ <https://arxiv.org/abs/1610.01873>

⁵⁴⁸ The author has created a free, cloud matrix multiplier tool that provides a realistic matrix cross product AND the 4th dimensional term.

<https://docs.google.com/spreadsheets/d/1dwu9AgiNKdtpH5V44W9CHbbRUvLcL2fsyRThfgG4T14/edit?usp=sharing>

⁵⁴⁹ Each entry in the 3-d array is a result of vector cross products. See figure 82

⁵⁵⁰ Ibid. “Vortrix Algebra,” pg 16

⁵⁵¹ <https://arxiv.org/pdf/1711.04876.pdf>

⁵⁵² <https://arxiv.org/pdf/1707.04182.pdf>

But what if Alfvén and Scott were wrong? What if electric current are merely a special form of magnetic dipole moment *in motion*? In the next sections, some very unorthodox and strange ideas will be presented by two very practicable *mystics* of the physics world: Leedskalnin and Tesla.

Edward Leedskalnin

Leedskalnin is easily most known for being a wild hermit that lived alone and built Coral Castle⁵⁵³ - a site in Florida made of coral carved megaliths. Not only did he build it alone, but he moved it once, all by himself⁵⁵⁴. However, he is also known for stating that he knew the levitation secrets of the Ancients⁵⁵⁵, such as Egyptians and Romans. The claim of magneto-gravitic levitation has come under serious fire^{556 557}, and footage has emerged of Leedskalnin using tripod hoists and very powerful winches⁵⁵⁸.

But like Tesla, Leedskalnin made some very unique and mysterious claims⁵⁵⁹, and numerological predictions⁵⁶⁰, which contain enough math⁵⁶¹ and science to entice the student of physics with the possibilities of finding true “zero-point” energy⁵⁶² control⁵⁶³. In each subsection, we will examine his words and works, and see what can be learned about our Magnetic Universe from the dipole moment model.

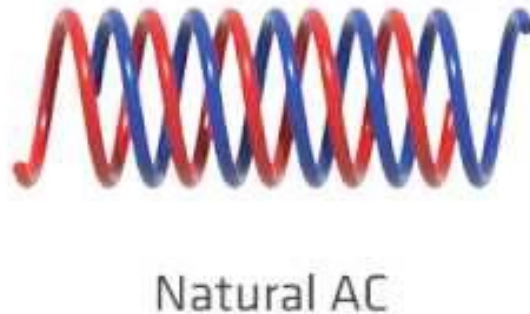

Figure 83 - Double Helix model of natural EMF; credit: Leedskalnin

⁵⁵³ https://en.wikipedia.org/wiki/Coral_Castle

⁵⁵⁴ <https://gizmodo.com/how-one-man-created-a-1-000-ton-coral-castle-in-1923-1443356836>

⁵⁵⁵ <https://grahamhancock.com/carrd4/>

⁵⁵⁶ <https://www.livescience.com/41075-coral-castle.html>

⁵⁵⁷ <https://www.youtube.com/watch?v=nOoCuDnmtYM>

⁵⁵⁸ <https://youtu.be/bH2N0bUss1s>

⁵⁵⁹ <http://www.coralcastlecode.com/>

⁵⁶⁰ <http://www.code144.com/tech/the-numbers-7129-6105195>

⁵⁶¹ <http://www.greatdreams.com/gem12.htm>

⁵⁶² https://en.wikipedia.org/wiki/Zero-point_energy

⁵⁶³ Which reminds the author of the continual belief by rabid fans of Tesla that he created a “free energy” device, which obviously violates the Laws of Thermodynamics; see Appendix B.II

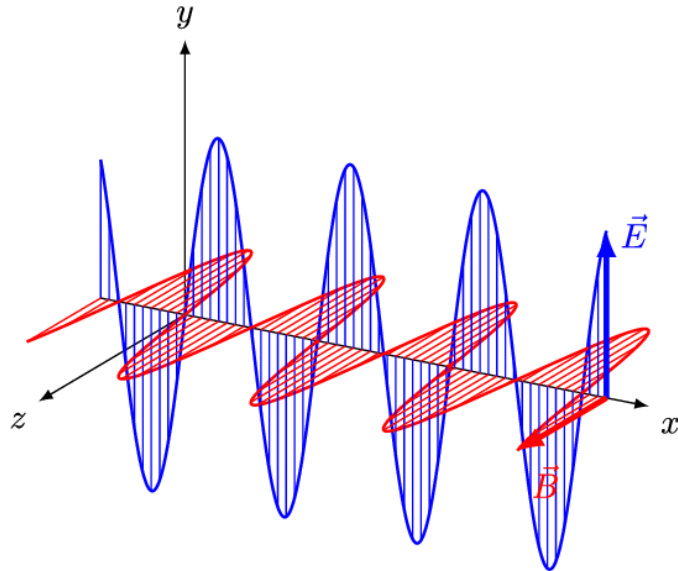

Figure 84 - Heaviside's EMF wave; credit: Wikicommons

The Magnetic Double Helix (Dipole) Model

Compare figure 83 with figure 15.6: they aren't all that different. So there is some immediate viability given. That should arrest the defenses of the reader just long enough to mention that DNA is also in this double helix shape⁵⁶⁴, and is known to be electrical in nature⁵⁶⁵. Furthermore, it should prove all the more valuable to the reader to understand that the 90 degree out of phase shape of this "Magnetic current"⁵⁶⁶ is, in fact, the electrical portion. They have measured these electric currents in the Van Allen belts and in AGN (see Table 7) to be pointed in the same direction as the magnetic flux, but 90 degrees out of phase⁵⁶⁷.

While the author does not make the claim that the Maxwellian wave is *wrong*, the author would like to remind the readership that it is possible, based on Distinti's Vortrix © work, that Heaviside himself was wrong, in assigning orthogonality to the vector cross product, rather than dimensionality.

>>After all, if one multiplies a length by width, one does not get height or depth, but an area.<<

So where are we left? Do we believe figure 83 or 84? The main attraction to figure 83 is that it better represents astronomical data (a form of laboratory), while we cannot truly see inside a photon (whatever one may be); and it reflects natural design, and it has *structure*, as opposed to be hollow or empty and violating angular momentum⁵⁶⁸. It also has *some* (but only a little) experimental evidence.⁵⁶⁹

As regards the electron and photon models, the follow quotes are what Leedskalnin had to say on the matter.

"Magnetic current is the same as electric current is a wrong expression. Really it is not one current they are two currents, one current is composed of North Pole individual magnets in concentrated streams, and the other is composed of South Pole magnets in concentrated streams, and they are running one stream against the other stream in whirling, screw like fashion, and with high speed. One current alone if it

⁵⁶⁴ [https://en.wikipedia.org/wiki/Double_helix_\(disambiguation\)](https://en.wikipedia.org/wiki/Double_helix_(disambiguation))

⁵⁶⁵ <https://www.sciencedaily.com/releases/2018/06/180618113017.htm>

⁵⁶⁶ http://www.pateo.nl/HTML/PD/TP/Magnetic_Current_by_Edward_Leedskalnin.pdf

⁵⁶⁷ Ibid. "The jets of AGN as giant co-axial cables", Gabuzda et al...

⁵⁶⁸ The helix oscillation results in conserved angular momentum (no net change). <https://youtu.be/Uurpts6ZFmo>

⁵⁶⁹ <https://youtu.be/SO3dXCsyBC4>

be North Pole magnet current or South Pole magnet current it cannot run alone. To run one current will have to run against the other.

"This is the way the North and South Pole individual magnets are running out of the coil's wire lengthwise. The reason the North and South pole individual magnets do not run across through the coils' wire as fast as they run in while in the coil is between the U shape magnet, the coil's wire is insulated, there is an air space around every wire and as it is known that the dry air is the best obstruction for the magnets to go through and as you know the coil is well insulated so the damp air does not get in. It is well known that it is many times easier for the magnets to run in metal than in air, now you see when the magnets run in the wire they hesitate to run out of the wire across the same way as they came in, so more of the new magnets are coming in the crosswise, then they can get out crosswise, so they get pushed out through the wire lengthwise. Now you know how the alternating magnetic currents are made.

"The real magnet is the substance that is circulating in the metal. Each particle in the substance is an individual magnet by itself, and both North and South Pole individual magnets.

"Millions of people all over the world are being fooled by the non-existing electrons. Here is how the electrons came into existence. Thomson invented an imaginary baby and called it an electron. Rutherford adopted it and now the men with the long hair are nursing it. The electron has a brother and its name is proton, but it is heavy and lazy. It remains stationary in the middle, but the electron has to run around it. To the electrical engineers the positive electricity is everything, the negative electricity is nothing, but to the physicists the negative electricity is everything, and the positive electricity is nothing. Looking from a neutral standpoint they cancel each other, so we have no electricity, but we have something. If we do not know how to handle the thing that comes through a wire from a generator or a battery, we will get badly shocked. Read the booklet "Magnetic Current" then you will know what the thing is, and the way it runs through a wire.

"The invention of an electron came by a tricky method in using electricity in a vacuum tube. Normally whether it be a generator or a battery, the positive terminal will have to be connected to the negative terminal, but in the vacuum tube two batteries with different strength were used, the smaller battery was connected normally, but the larger battery's negative terminal was connected to the smaller battery's negative terminal, and the positive terminal was left alone. That connection gave the negative terminal a double dose of strength, and so it became hotter and could push more. It was called cathode and the positive terminal anode, and the electricity that passed from the cathode to the anode was called electrons.

"In case the inventor had used normally direct methods to find out what the electricity was he would have found out that the positive and negative electricity is in equal strength, and are running positive electricity against the negative electricity. That can be seen by connecting each of two pieces of soft iron wire with each terminal of a car battery and then by putting together and pulling away each loose end of the soft iron wire. More sparks can be seen coming out of the positive terminal than from the negative terminal. This direct method is more reliable than the tricky method in the vacuum tube. The trouble with the physicists is they use indirect and ultra-indirect methods to come to their conclusions.

"If the inventor of electrons had a vacuum tube in which his electrons could run close to the top of the vacuum tube from the west side of the cathode to the east side of the anode and then would hang a vertically hanging magnet that is made from three-inch long hard steel fishing wire, and then hang one magnet pole at one time right on top in the middle of his stream of electrons, then he would have seen the north pole magnet swinging north, and the south pole magnet swinging south. The same thing will happen if the magnets are held above any wire where the electricity is running through. Those two vertically hanging magnets prove that the electricity is composed of two different and equal forces. Another way to prove this is to connect a flexible wire loop east end of the wire with positive battery's terminal, west end with negative terminal, raise the loop one inch above the floor. Put U shape magnet one inch from loop, north pole south side of the loop. The north pole magnet will pull in the loop. Put the south pole magnet in the same place. It will push the loop away. Put the south pole magnet north side of the loop, this time it will pull the loop in. Put the north pole magnet in the same place, it will push the loop away. This indicates that electricity the same

as a magnet bar is composed of two equal forces, and each force is running one against the other in whirling right hand twist, but those forces in the wire have higher speed, and both forces are coming out across from the same wire. One of the forces is north pole magnets and the other is south pole magnets. They are the cosmic forces. Your electric motor is turned around on its axis by north and south pole magnets. Even you could not start your car without the north and south pole magnets.

“If electricity is made with north and south pole magnets and the electric motor is turned around on its axis by the north and south pole magnets as is the fact, then this will bring up a question, where then are those Thomson electrons. They are not around the electric motor. The plain answer is they are non-existing.”⁵⁷⁰

The meaning here is unambiguous: Leedskalnin maintains the electron is not only unnecessary but a falsity. That the polarity is unipolar: singular. One Tao, essentially.

This concept⁵⁷¹ has been revisited by Professor Tombe, and awaits greater scientific community evaluation.⁵⁷²

Spheroidal Magnetism

The reader will recall that Robert Distinti made an assertion about spheroidal magnetism. Leedskalnin has something to say on this as well,

“Now about the sphere magnet. If you have a strong magnet you can change the poles in the sphere in any side you want or take the poles out so the sphere will not be a magnet any more. From this you can see that the magnet can be shifted and concentrated and also you can see that the metal is not the real magnet. The real magnet is the substance that is circulating in the metal. Each particle in the substance is an individual magnet by itself, and both North and South Pole individual magnets. They are so small that they can pass through anything.. In fact they can pass through metal easier than through the air. They are in constant motion, they are running one kind of magnets against the other kind, and if guided in the right channels they possess perpetual power. The North and South Pole magnets they are cosmic force, they hold together this earth and everything on it. Each North and South Pole magnet is equal in strength, but the strength of each individual magnet doesn't amount to anything. To be of practical use they will have to be in great numbers.

In permanent magnets they are circulating in the metal in great numbers, and they circulate in the following way: Each kind of the magnets are coming out of their own end of the pole and are running around, and are running in the other end of the pole and back to its own end, and then over and over again. All the individual magnets do not run around. Some run away and never come back, but new ones take their place.

The earth itself is a great big magnet. In general these North and South Pole individual magnets are circulating in the same way as in the permanent magnet metal. The North Pole individual”⁵⁷³ [sic]

So, according to Leedskalnin, the magnetic field is unambiguously toroidal, even in a spherical shape. Perhaps Distinti is totally wrong, or perhaps the difference is as Hawkins has said: Electricity is radiative, whereas Magnetism is rotational. However, Leedskalnin was unambiguous in the previous section: he does

⁵⁷⁰ <http://www.leedskalnin.com/>

⁵⁷¹ <https://youtu.be/a4sOR66VlPk>

⁵⁷² http://www.leedskalnin.com/the_double_helix_theory_of_the_magnetic_field.pdf

⁵⁷³ <http://www.leedskalnin.com/Leedskalnins-Writings-MAGNETIC-CURRENT.html>

not feel electricity is due to “electrons” (let alone muons or quarks). The author leaves it to the reader to decide whom to believe.

Magneto-gravitics

As regards magnetic-gravity, Leedskalnin has this to say,

“Gravitation must be caused by the matter in the middle of the earth⁵⁷⁴, and more concentrated than Uranium.⁵⁷⁵ When Uranium atoms burst they release the North and South pole individual magnets that held the atom together, then the magnets scatter all around, they can only pass from the middle to the outside. When the North and South pole magnets are running alongside each other and in the same direction, they have no attraction for the other kind. They only attract if they are running one kind against the other kind. When the magnets are running out of the middle of the earth, as soon as they meet an object they attract it, on account of the fact that in any object there is both kinds of magnets in it. It can be seen by rubbing hard rubber or glass until they get hot., then they will attract sand, iron filings, salt, and other things. To see how it functions, move a salt crystal a little, if it happens to get on a different magnet pole, then it will jump away. Another way is to rub hard rubber until it gets hot, then it will be a temporary magnet. The difference between the rubber magnet and the steel magnet is both North and South poles are in the same side of the rubber and the magnet poles are small and there are many of them close together, but the surplus magnets in the circulating magnet that was put in it. Attract the iron filings with the rubber magnet, then approach with the steel magnet, Change the poles, then you will see some of the filings jump away. This means the steel magnet changed the magnet poles in the iron filings, and so they jumped away.”

“Here is additional information for those who read my advertisement in The Miami Daily News, February 3rd, 1946. The North and South pole individual magnets are the cosmic force. They are the building blocks of nature's perpetual transformation of matter, and they are so small that they can pass through everything,. They pass through the earth from pole to pole, and around the earth. If the North and South pole individual magnets could not pass through a vacuum tube the same as the Thomson's electrons cannot, then they could not be the building blocks. The Thomson electrons are very small parts of matter which come out of the cathode while the cathode is burned up or consumed in the vacuum tube. Without the general circulation of the building blocks there would be no change. Everything would remain the same way as it is now. The building blocks from a matter that go to pieces could not get in the general circulation for the new construction.

I think the Radium and Uranium were built up inside the earth with high pressure, and heat, while the North and South pole individual magnets were circulating through the earth. During the time the Radium and Uranium were inside the earth they absorbed more of the individual North and South pole magnets than they normally could hold, and so now while they are on top of the earth they let the magnets go so they can become normal again.⁵⁷⁶ [sic]

The author would like to stress that although Leedskalnin has a model in his mind, no obvious model has been made clear to him, which would suggest Leedskalnin had improved gravitics, which is definitely different than both Tesla and the Structured Atomic Model which have specific proposals (see below). Once again, that doesn't mean that Leedskalnin was necessarily wrong. However, in the evolution of models, both structure (with accompanying lab evidence) and mathematics to describe are what it takes to replace a previous gravity model.

⁵⁷⁴ The author would refer to the PEMS paper discussion of heavy water reactor core aspect of HEGEME theory, [4].

⁵⁷⁵ <https://www.sciencedaily.com/releases/2011/12/111219112216.htm>

⁵⁷⁶ Ibid.

The graviton and photon models are almost assuredly wrong. They have no logical basis. They are both the results of advanced mathematics which might be faulty in the first place. Both models work best when they make no claim towards knowing the **suchness** of the concept they model. But what we are interested in, in the Plasma-electromagnetic Universe and EPEMC in general, and its viable alternatives.

Megalithic Levitation

Regarding Ed's practicability in using magnetic gravitics, it appears to be more a matter of applied mechanics and supplied power via electricity and magnetism, than any sort of *magic*. The author proposes it very may well be possible to, say, use a laser to entangle two bodies of matter, and then cause the behavior of one to alter via the other. or control the relationship of the electromagnetic field. However, video evidence and rational thought (as well as the fact that no one else has figured out how to do it, barring acoustic levitation⁵⁷⁷) dictate we must assume the simplest evidence:

1. Electric Battery
2. Magnetic commutator
3. Electric motor
4. Winch and pulley system
5. Tripods (the size of telephone poles)
6. Hefty ropes^{578 579}
7. 28 years of time and applied, earnest, testing.

In all honesty the most amazing thing, aside from the carving, is that he never crushed himself.

Magnetic Current

Continuing his lecture,

"Magnetic currents, or if you want to call it electric current, make no light. We only get light if we put obstructions in the light bulbs. In the light bulbs the wire is so small that all magnets cannot pass through easily, so they heat the wire up and burn and make light. If the wire in the light bulb had been as large inside as it is outside then there would be no light. Then those individual magnets which are in the coil would dissipate in air.

"You made magnetic currents in three different ways, but in principle they all were made exactly in the same way. Magnetic currents are made by concentrating. then dividing and then shifting the existing North and South Pole individual magnets from one place to another. Now I will illustrate how my best machine is doing it. I will use only one coil, and one U shape permanent magnet without using the winding that the machine uses to increase the permanent magnet strength. If you had a permanent magnet that the coil you use in the electric magnet [sic] would go in between the prongs of it, then that would be good to demonstrate, but if you have not, then use the same one you have. Get an iron core the same dimensions as in the three-inch coil, but long enough to go between the permanent magnet prongs. Wind the same number of turns and connect with the light bulb. Fasten the U shape permanent magnet very good, bend up, prongs down, North Pole North. South Pole South. Now push the coil

⁵⁷⁷ Although reports of Tibetans and Hindus using horns to levitate megaliths are available, and acoustic levitation is documented, there is no evidence Ed used any such devices here. Reports of lights were seen, but not long high pitched or deeply intoned sounds. The only major sound ever reported was the slamming down of the obelisk onto the loading truck. Strangely enough no cranes were reported by the truck driver. Some speculated about a strange tuning fork apparatus, but no such fork has ever been found. See next section.

⁵⁷⁸ In a separate project involving moving standard 2.5 ton Giza stone blocks, the author researched on ropes and found that substantially thick ropes can hold many tons of weight more than the public is generally aware of.

<http://www.lanex.cz/en/marine-ropes-technical-parameters>

⁵⁷⁹ <https://www.ropeinc.com/ropetensilestrength.html>

through the prongs from West to East. Do it fast, then there will be light in the bulb, now push the coil and stop in middle, and then push again, this time you will have two lights while the coil went through the magnet prongs only once. You had two lights the first time also, but you did not notice they came in quick succession, When you pushed the coil's middle up to field magnet's middle the currents ran in one direction, and when you pushed the coil away from the field magnet's middle, then the currents reversed, then ran in the other direction. That is why you got two light flashes while the coil passed through the field magnet only one time.

*“The reason I call the results of North and South Pole magnet's functions magnetic currents and **not electric currents or electricity is the electricity is connected too much with those non-existing electrons.** If it had been called magneticity then I would accept it. Magneticity would indicate that it has a magnetic base and so it would be all right.*

“As I said in the beginning, the North and South Pole magnets they are the cosmic force. They hold together this earth and everything on it, and they hold together the moon, too. The moon's North end holds South Pole magnets the same as the earth's North end. The moon's South end holds North Pole magnets the same as the earth's South end. Those people who have been wondering why the moon does not come down all they have to do is to give the moon one- half of a turn so that the North end would be in South side, and South end in the North side, and then the moon would come down. At present the earth and the moon have like magnet poles in the same sides so their own magnet poles keep themselves apart, but when the poles are reversed, then they will pull together. Here is a good tip to the rocket people. Make the rocket's head strong North Pole magnet, and the tail end strong South Pole magnet, and then shut to on the moon's North end, then you will have better success.

“North and South Pole magnets are not only holding together the earth and moon, but they are turning the earth around on its axis. Those magnets which are coming down from the sun they are hitting their own kind of magnets which are circulating around the earth and they hit more on the East side than on the West side, and that is what makes the earth turn around.

North and South Pole magnets make the lightning, in earth's North hemisphere the South Pole magnets are going up and the North pole magnets are coming down in the same flash. In the earth's South hemisphere the North Pole magnets are going up and the South Pole magnets are coming down in the same flash. The North lights are caused by the North and South Pole magnets passing in concentrated streams, but the streams are not as much concentrated as they are in the lightning. The radio waves are made by the North and South Pole magnets.

Now about the magnet size. You know sunlight can go through glass, paper and leaves, but it cannot go through wood, rock and iron, but the magnets can go through everything. This shows that each magnet is smaller than each particle of light.”⁵⁸⁰ [sic]

So in essence, it's a semantics issue. He **is** talking about the same thing we are all talking about, and he is expressing the belief - the pragmatic as well as theoretical belief that EMF is the Unified Field, which would indeed make PEM the UAF.

The Life of Phi

Returning to the mystique of Mr. Leedskalnin's "levitation" [tuning fork], some have speculated it had to do with his knowledge of the Golden Ratio, also known as Phi.

$$\Phi = \frac{\sqrt{5} + 1}{2}$$

Figure 85 - Phi

Of course the ratio he left behind was *not* expressed in this way. Rather it was left as a pair of numbers (and no indication as to some form of tabulation, or mental meditation, etc...):

⁵⁸⁰ Ibid.

- ❖ 7129
- ❖ 6105195

The division of which yields: 0.0011676940703778

The above equation in figure 85 yields 1.618033988749895

Naturally, one of the speculations was that his ratio was a shifted version ($10^{-3} + .001$ off) of the real value of the Golden Ratio. However, strong evidence suggests that it was merely coincidental as the same numbers were found on his naturalization certificate.⁵⁸¹ The author concurs that there appears to be nothing substantial to the idea that one can create a tuning fork using those values and achieve “anti-gravitation”.

Tesla Revisited - Magnetic Gravity

If the reader thought that Leedskalnin was - rather straightforward - then what the immortal Nikola Tesla had to say may astound the reader,

“I have worked out a dynamic theory of gravity in all details and hope to give this to the world very soon. It explains the causes of this force and the motions of heavenly bodies under its influence so satisfactorily that it will put an end to idle speculations and false conceptions, as that of curved space. According to the relativists, space has a tendency to curvature owing to an inherent property or presence of celestial bodies.

“Granting a semblance of reality to this fantastic idea, it is still very self-contradictory. Every action is accompanied by an equivalent reaction and the effects of the latter are directly opposite to those of the former. Supposing that the bodies act upon the surrounding space causing curvature of the same, it appears to my simple mind that the curved spaces must react on the bodies and, producing the opposite effects, straighten out the curves.

“Since action and reaction are coexistent, it follows that the supposed curvature of space is entirely impossible -However, even if it existed it would not explain the motions of the bodies as observed. Only the existence of a field of force can account for them and its assumption dispenses with space curvature. All literature on this subject is futile and destined to oblivion.”⁵⁸²

It may be fair to say that Tesla was not a fan of Einstein’s General Relativity.

“Supposing that the bodies act upon the surrounding space causing curving of the same, it appears to my simple mind that the curved spaces must react on the bodies, and producing the opposite effects, straightening out the curves. Since action and reaction are coexistent, it follows that the supposed curvature of space is entirely impossible – But even if it existed it would not explain the motions of the bodies as observed. Only the existence of a field of force can account for the motions of the bodies as observed, and its assumption dispenses with space curvature. All literature on this subject is futile and destined to oblivion. So are all attempts to explain the workings of the universe without recognizing the existence of the ether and the indispensable function it plays in the phenomena.”⁵⁸³

“I hold that space cannot be curved, for the simple reason that it can have no properties. It might as well be said that God has properties. He has not, but only attributes and these are of our own making. Of properties we can only speak when dealing with matter filling the space. To say that in the presence of large bodies space becomes curved is equivalent to stating that something can act upon nothing. I, for one, refuse to subscribe to such a view.”⁵⁸⁴

⁵⁸¹ http://www.code144.com/image_database/44/442734_e49b1437c5_the-numbers---7129-6105195.jpg

⁵⁸² <https://teslaresearch.jimdo.com/dynamic-theory-of-gravity/>

⁵⁸³ 81st birthday in July 10, 1937

⁵⁸⁴ New York Herald Tribune in 11 September, 1932

Despite their disagreements regarding curved space, Einstein and Tesla had a few things to say about the Aether (Ether),

*"The ether of the general theory of relativity is a medium which is itself devoid of all mechanical and kinematical qualities, but helps to determine mechanical (and electromagnetic) events."*⁵⁸⁵

*"To deny ether is ultimately to assume that empty space has no physical quality whatever. The fundamental facts of **quantum mechanics do not harmonize with this view.**"*⁵⁸⁶ ~Einstein

*"According to an adopted theory, every ponderable atom is differentiated from a tenuous (fragile, vague) fluid, filling all space merely by spinning motion, as a whirl of water in a calm lake. By being set in movement this fluid, the ether, becomes gross matter. Its movement arrested (halted), the primary substance reverts to its normal state. It appears, then, possible for man through harnessed energy of the medium and suitable agencies for starting and stopping ether whirls to cause matter to form and disappear. At his command, almost without effort on his part, old worlds would vanish and new ones would spring into being. He could alter the size of this planet, control its seasons, adjust its distance from the sun, guide it on its eternal journey along any path he might choose, through the depths of the universe. He could make planets collide and produce his suns and stars, his heat and light; he could originate life in all its infinite forms. To cause at will the birth and death of matter would be man's grandest deed, which would give him the mastery of physical creation, make him fulfill his ultimate destiny."*⁵⁸⁷ (Tesla)

Continuing the discussion though, of their differences of opinions,

"We read a great deal about matter being changed into force and force being changed into matter by the cosmic rays. This is absurd. It is the same as saying that the body can be changed into the mind, and the mind into the body. We know that the mind is a functioning of the body, and in the same manner force is a function of matter. Without the body there can be no mind, without matter there can be no force.

Einstein has for years developed formulas explaining the mechanism of the cosmos. In doing this he overlooked an important factor, namely the fact that some of the heavenly bodies are increasing in distance from the sun. This is the same as writing a business letter and forgetting the subject you wish to write about. In order to explain this phenomenon Einstein has invented the quantity "lambda".

*My theory of gravitation explains this phenomenon perfectly"*⁵⁸⁸

However, Tesla could be, and often times was, wrong as regards atomic theory,

"The idea of atomic energy is illusionary but it has taken so powerful a hold on the minds, that although I have preached against it for twenty-five years, there are still some who believe it to be realizable.

"I have disintegrated atoms in my experiments with a high potential vacuum tube I brought out in 1896, which I consider one of my best inventions. I have operated it with pressures ranging from 4,000,000 to 18,000,000 volts. More recently I have designed an apparatus for 50,000,000 volts which should produce many results of great scientific importance.

⁵⁸⁵ Albert Einstein - University of Leiden - 5 May 1920

⁵⁸⁶ 1920; <https://youtu.be/yCm6eLP9zRw>

⁵⁸⁷ New York Times - April 21, 1908

⁵⁸⁸ April 15, 1932

*"But as to atomic energy, my experimental observations have shown that the process of disintegration is not accompanied by a liberation of such energy as might be expected from the present theories."*⁵⁸⁹

*"There is no more energy in matter than that received from the environment"*⁵⁹⁰

Yet, in other ways he was well ahead of his time, making many predictions in his autobiography's last pages that came true in the 20th Century. Furthermore, he described plasma/cosmic ray harvesting that will, the author believes, finally be the "Aether" or "Free Energy" harvesting that mankind so desperately needs.

"The attractive features of the Cosmic rays is their constancy. They shower down on us throughout the whole 24 hours, and if a plant is developed to use their power it will not require devices for storing energy as would be necessary with devices using wind, tide or sunlight."

"All of my investigations seem to point to the conclusion that they are small particles, each carrying so small a charge that we are justified in calling them neutrons. They move with great velocity, exceeding that of light."

*"More than 25 years ago I began my efforts to harness the cosmic rays and I can now state that I have succeeded in operating a motive device by means of them."*⁵⁹¹



Figure 86 - The electron (early model) collapsing into the Aether; credit: TeslaResearch⁵⁹²

The author does not propose that Tesla had any better defined version of gravity than Einstein or Poincare. This is merely to point out that one of the most pragmatic men of the history of Physics, who was wrong about cosmic ray velocity and quantum/nuclear energy, did in fact also speak out against Relativity and instead for a form of electromagnetic current networking the Universe.

David LaPoint

LaPoint is not of the same eminence as Tesla or Leedskalnin, however he is a practicable man with some laboratory experimentation⁵⁹³ with basic magnetism, and some patents⁵⁹⁴. Below in Figure 87 is the basic

⁵⁸⁹ New York Times - July 5th, 1931

⁵⁹⁰ October 13, 1932; of course he could not know there were two forces yet to be discovered holding the atom together.

⁵⁹¹ Tesla Cosmic Ray Motor May Transmit Power 'Round Earth - Brooklyn Eagle - July 10, 1932, by John J. A. O'Neill

⁵⁹² Ibid.

⁵⁹³ <https://www.youtube.com/watch?v=9EPlyiW-xGI>

⁵⁹⁴ <https://www.youtube.com/watch?v=2NogyJ0k8Kw>

LaPointian “Double bell” magnetic shape⁵⁹⁵. Compare with Figure 88 and 89. LaPoint is also known for having creating a sort of “monopole”⁵⁹⁶, that is to say, a custom made magnet which favors one side of the poles versus the other.

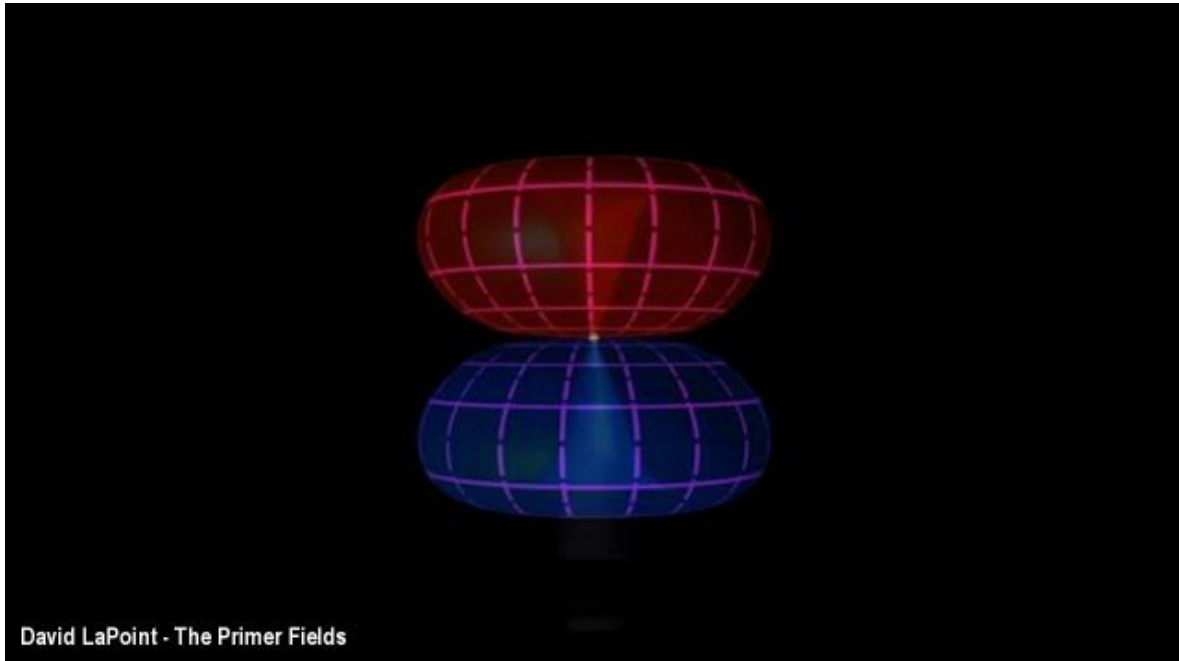

Figure 87 - LaPointian Double Bell model

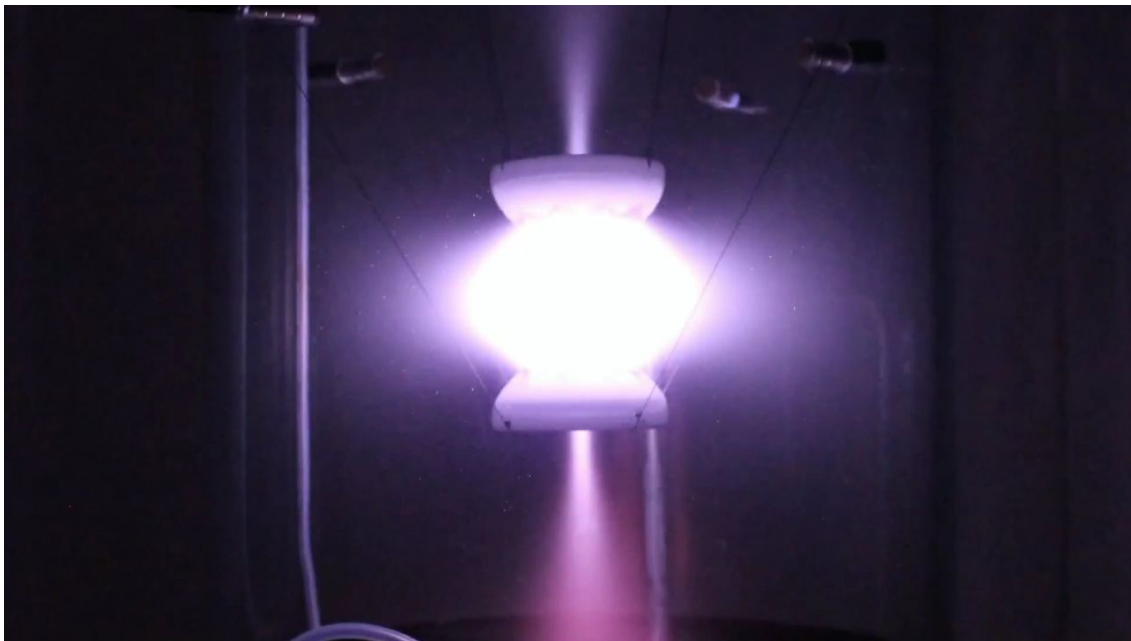

Figure 88 - LaPoint plasma/B field experiments; credit: D LaPoint

⁵⁹⁵ <https://www.youtube.com/watch?v=lpI6ikj1G-s>

⁵⁹⁶ <https://www.youtube.com/watch?v=HSDolf5FY2s>

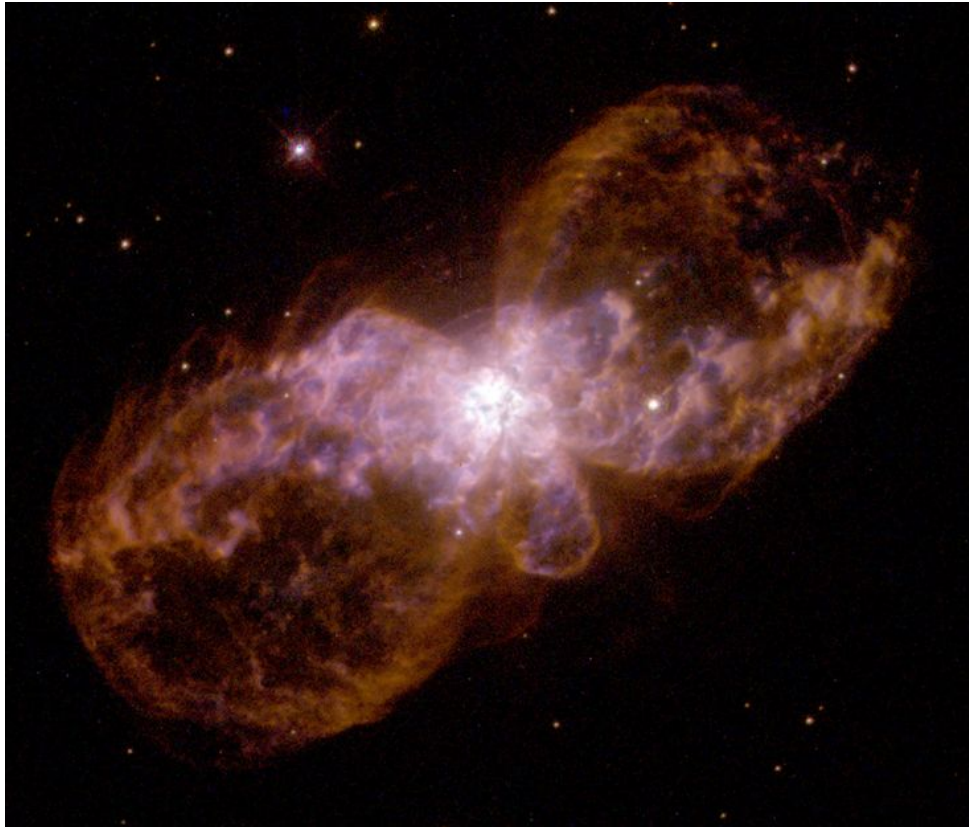

Figure 89 - Nebulae displaying double bell shape (aka “Bulbs”); credit: NASA

Criticisms

All of these alternative views of magnetism and gravity are fascinating, and posed by practical men (as opposed to theoreticians and academics). However, what they lack is development. For now, they must remain quite alternative.

However, we must take seriously the idea that a “Magnetic Current” is only a semantic mirror of our UAF, that is what we have insisted is the Plasma-EMF. Then the development sought is found in previous discussions: high energy plasma physics, quantum mechanics, QED, MHD, and classical electromagnetism as well as New Electromagnetism. What is missing will be discussed in part V below.

However, another criticism needs to be discussed, first and foremost it is that many of these alternative theories do not quite dispatch of Relativity theory⁵⁹⁷ and a false understanding of gravity waves, let alone Big Bang, black holes, and the Dark Universe^{598 599}. Rather, like MOND, it smacks of stubborn opposition to scientific evolution, which is doomed to fail⁶⁰⁰.

However, the criticisms of the electron⁶⁰¹, and the photon especially, are quite merited⁶⁰². In some cases, they may be spot on. But in other cases, such as Tesla’s incorrectness about nuclear energy and radiation, it is not of much use anymore. In establishing our EPEMC, we must only deal squarely with a UAF that satisfies all the observed facts, without holding to one’s favorite scientist(s) or camp of thought.

⁵⁹⁷ <http://www.eso.org/public/news/eso1819/>

⁵⁹⁸ <https://www.nature.com/articles/s41586-018-0204-1>

⁵⁹⁹ http://www.esa.int/Our_Activities/Space_Science/XMM-Newton_finds_missing_intergalactic_material

⁶⁰⁰ <https://arxiv.org/pdf/1804.00664.pdf>

⁶⁰¹ <https://physicsworld.com/a/electrons-magnetic-interactions-isolated-at-long-last/>

⁶⁰² <https://physics.stackexchange.com/questions/127212/has-the-photon-both-gravitational-and-inertial-mass>

V - Plasma-Electromagnetism (PEM)

It could be termed PEM, or PEMF (force), or even PEWF (electroweak). If one is inclined, it could be termed PEMWGF (electromagnetic-weak-gravity⁶⁰³). However, nobody has yet reconciled the Strong Force. Or have they not? In the following section the author will introduce the readership to a new, exciting, logical atomic model which eliminates the need for neutrons altogether, and returns the Universe (and cosmology of EPEMC) the world of philosophically sound polarity (not duality!).

1. Protons = elements = yin⁶⁰⁴ = slow and stable = the world of material
2. Electrons = EMF = UAF = yang = fast and active (Charged) = the immaterial (hence undetectable⁶⁰⁵ except via effects)⁶⁰⁶

Bear in mind that the Strong Force only refers to the keeping of neutrons in proximity to each other, as they are that which holds protons together. Therefore if internal to a neutron is merely a proton and an electron in close orbit, then the difference in relative strength of the EM and Strong forces (102-1000x)⁶⁰⁷ would be explainable by the shortened distance allowed between them.

Please also remember, that isotopes behaving differently is now explained simply as *more elements than previously thought*. More on that in the next to last section.

The Structured Atom © Hypothesis

The Structure Atomic Model (SAM)⁶⁰⁸ is a new type of nuclear model based upon Platonic Solids⁶⁰⁹. Not only is this highly logical, it may provide insight into chemical and physical behaviors by helping us to predict certain nuclear shapes and groups which, in fact, repeat. Imagine being able to identify every chemical that is bad for human health and the environment, by being able to identify a certain nucleus group which always behaves in a certain way? This is what may be possible when we start to consider the platonic groupings which define SAM.

SAM, of course, comes with its own new atomic shapes⁶¹⁰ and even a new Periodic Table will be made. At this time, the best we can do is to view the dynamic models as they are being built⁶¹¹.

The most intriguing aspect of SAM, as noted above and in the cited video, is the aspect of eliminating the neutron as an intermediary particle; see Figure 90. The one obstacle however, has to do with mass (see Table 14). It is not made up with by mere subtraction. However, Wal Thornhill (see Part II above) has hypothesized that the issue of mass is not an issue of *matter* but of **Charge**, as mass is better measured, in Quantum mechanics/QED, in MeV. Again, refer to Table 14.

If this is correct, then also will the mass of stars necessarily change (as well as Earth's G), with relative voltage (to the interstellar and stellar mediums/wind, respectively) around the body. This makes logical and intuitive sense.

⁶⁰³ Double entendre

⁶⁰⁴ As it turns out, engineers have it right: protons are actually negative. The convention created by Franklin is backwards!

⁶⁰⁵ Literally changing positions: see Schrödinger's Equations https://en.wikipedia.org/wiki/Schr%C3%B6dinger_equation

⁶⁰⁶ In actuality, the Immaterial, the Force, is creating the world of material through its manifestation as electricity and magnetism. One could call this Force Electricity only, or Magnetism only, and it is true, either way. Both are known effects to us now. Both have been seen. What we struggle with is accepting they are the *same* effect, with different manifestations. It is the same origin point, but different vectors, and that is all. All the forces and field effects are all related to this same Origin.

⁶⁰⁷ See Table 13

⁶⁰⁸ <https://etherealmatters.org/sam>

⁶⁰⁹ https://en.wikipedia.org/wiki/Platonic_solid

⁶¹⁰ <https://www.youtube.com/watch?v=sJKW9VNo2BU>

⁶¹¹ <https://etherealmatters.org/atomizer/atom-viewer>

Table 14 - Comparison of mass of particles

Proton	$1.6726219 \times 10^{-27}$ kg	938.27203 MeV/c ²
Electron	$9.10938356 \times 10^{-31}$ kg	510.9989 keV/c ²
Neutron	1.674929×10^{-27} kg	939.56536 MeV/c ²
Neutron - Proton	2.306×10^{-30} kg ⁶¹²	1.293 MeV/c ²
Proton + Electron	$1.674929\dots9 \times 10^{-27}$ kg	938.783 MeV/c ²
Proton / Electron ⁶¹³	1836.153	
Neutron - (Proton + Electron)	1.395×10^{-30} kg	782.3 keV/c ²
Neutron / Proton	1.001378	
Neutron / Electron ⁶¹⁴	1838.684	

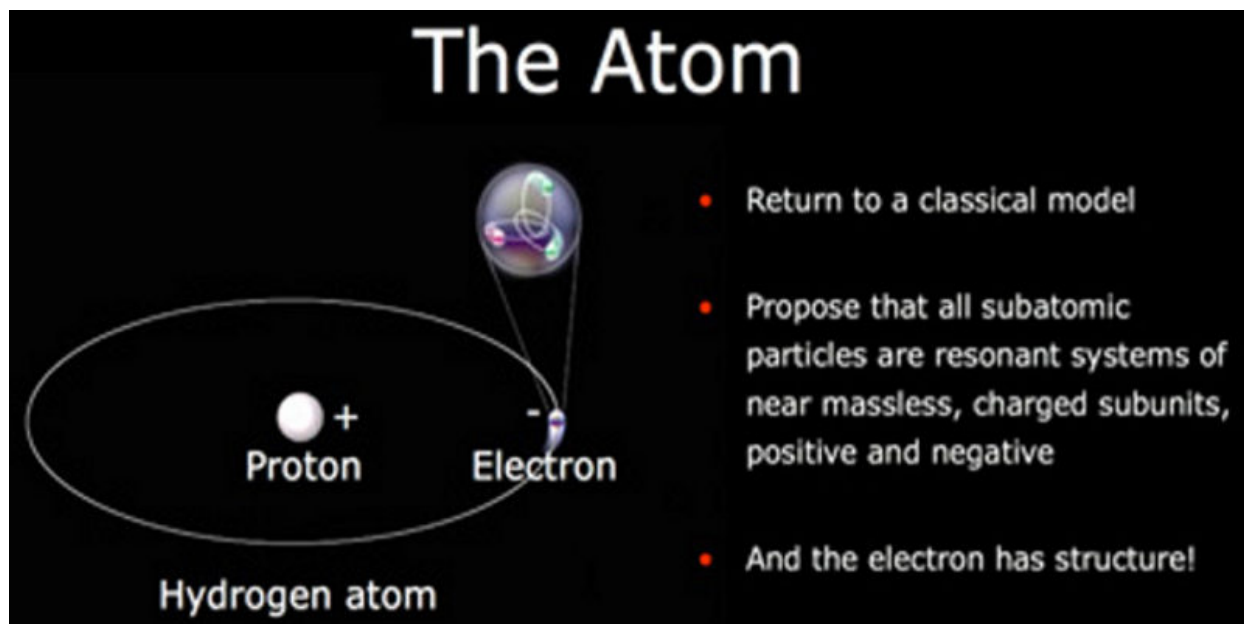

Figure 90 - Structured Hydrogen; credit: everythingselectric.com⁶¹⁵

⁶¹² Wolfram Alpha for mass comparisons

⁶¹³ A human ovum / sperm size ratio is 3-65:1 ; so this ratio is 10² more significant (as a yin:yang ratio); the EMF:EWF is 10⁷ or 10,000x more significant a ratio than Proton/Electron size

⁶¹⁴ Only 1 significant figure more than the Strong Force/EMF ratio!

⁶¹⁵ <https://www.everythingselectric.com/elements-electric-universe/>

Helium 3

🔄
📄
✂
▶
⊗
📺
?

Atom Properties

Stability: Stable
 Isotope: -1
 # Protons: 3
 # Inner electrons: 1
 # Outer electrons: 2
 Nuclear Spin: 1/2

Atom Description

Helium 3 is an incomplete tetrahedron (Helium 4). It consists of 3 protons in a triangular shape with 1 inner electron. The other 2 electrons are in the outer orbital (complete S-orbital).

He3 is stable and is formed as a result of Tritium decay. Natural abundance is considered very low.

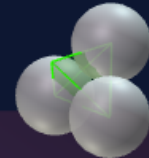
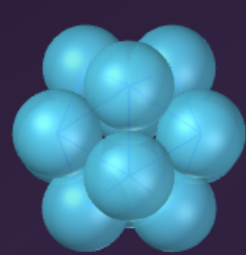

Figure 91 - He^{3,616} credit: Ethereal Matters⁶¹⁷

Carbon 12



Carbon 14

Stable Core

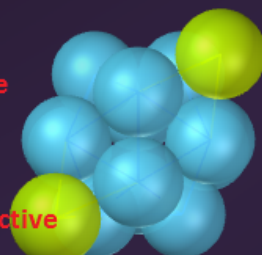

Radioactive

Nitrogen 14

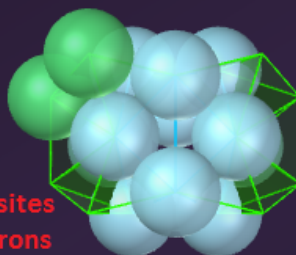

"receptor" sites
= free electrons

Oxygen 18

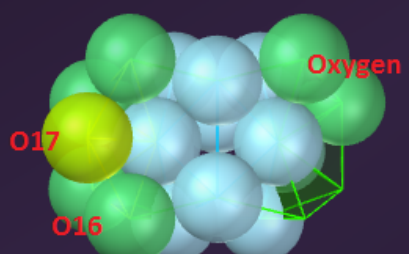

O17

O16

Final Stable (inert) form

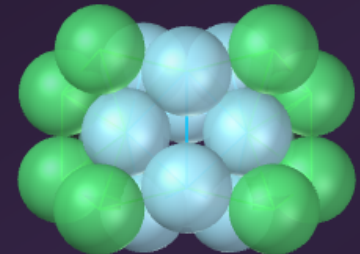

Neon 20

🔄
📄
✂
▶
⊗
📺
?

Atom Properties

Stability: Stable
 # Protons: 20
 # Inner electrons: 10
 # Outer electrons: 10
 Nuclear Spin: 0

Atom Description

Neon has 3 stable isotopes, Ne20, Ne21 and Ne22

Figure 92 - the Making of Ne²⁰ from C¹²; credit: Ethereal Matters

⁶¹⁶ Wants to be more stable tetrahedron (and inert) but remains open

⁶¹⁷ Note that H² (Deuterium) is the model for new neutron: two protons with an inner electron (causing an outer electron)

Copper 63

ⓘ ✎ ▶ ✕ 📺 ?

Atom Properties

Stability: Stable
 # Protons: 63
 # Inner electrons: 34
 # Outer electrons: 29
 Valence: 1, 2
 Nuclear Spin: 3/2-

Atom Description

30 outer electrons in stead of 29 electrons in the PTE.

When considering that there is one missing noble gas before Copper, the number of 30 outer electron is likely correct.

The nucliet ending is essentially the same as Oxygen. Further research is needed to make proper correlations.

Note: It seems that the more outer electrons are 'bound' to the inner part of the nucleus (the so called extra neutrons in relation to the number of protons), the more positive the elements become meaning a

Select Atom

10	Neon 21
10	Neon 22
11	Sodium - Natrium 23
12	Magnesium 24
13	Aluminum 27
14	Silicon 28
15	Phosphorous 31
16	Sulpher 32
17	Chlorine 35
17	Chlorine 36
18	Argon 36
18	Argon 38
19	Potassium 39
20	Calcium 40
21	Scandium 45
22	Titanium 46
23	Vanadium 51
24	chromium 52
25	Manganese 55
26	Iron 56
27	Cobalt 57
28	Nickel 58
29	copper 58 try-out
29	Copper 63

Figure 93 - Cu⁶³; credit: Ethereal Matters⁶¹⁸

Electrogravity

But what about Gravity? In PEMC (uses: EMWGF), the gravitational effect is the result of charge distribution to opposing surfaces (much as membranes in cells do,) to create charge differentials between insides and outside of cells, (for active osmosis) aligning in a way to make the capacitive shells/orbits we see in the atoms and celestial bodies (Figure 94)... everything. It has been argued that this would create too much attraction between normal sized bodies. But this is not true, because all of us live at relative 0 (to Earth), in the Universe, and therefore our charge differences are only large enough to create small static discharges, which are basically nothing compared to the differentials of celestial bodies.

⁶¹⁸ Normally is said to have 29 protons. The geometry shows the stable structure but highly electrically active geometry at a "receptor" site

Electric Gravity

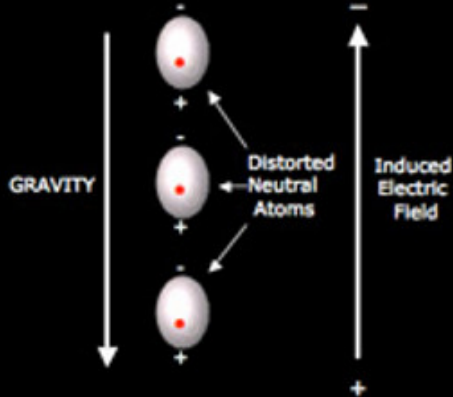

- Every particle within each atom is made of orbiting ~ 0 mass charges
- Every subatomic particle is distorted by the presence of others to form a tiny electric dipole
- Like magnets that are free to rotate, all the electric dipoles in protons, neutrons & electrons line up to produce - GRAVITY
- Neutral atoms distorted by gravity induce an electric field inside a body

Figure 94 - Electric Gravity; credit: everythingselectric.com⁶¹⁹

Charged Planets

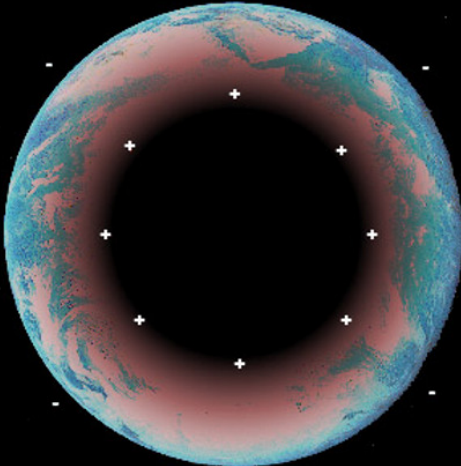

- Gravitationally induced dipoles tend to separate charge - planet acts like an 'electret'
- Free electrons tend to drift toward the surface
- Like a particle accelerator — the electrical stress modifies the apparent mass of the planet
- Removing electrons from the surface through lightning etc. reduces the mass of a planet

Figure 95 - Charged Planets' Shells; credit: everythingselectric.com

The author would make a wattage comparison, but measurement of voltage between poles of other planets is not reliable enough to compare with Earth. The power of a typical static discharge is: 800W-4.5 MW⁶²⁰.

⁶¹⁹ <https://www.everythingselectric.com/electric-gravity/>

⁶²⁰ <http://amasci.com/elect/elefaq1.html#aq>

Electrokinetics

The obscure work of TT Brown, Woodward, Nordtvedt, Zinsser, Biefeld, Jefimenko, et al... would be best discussed in relation to the pursuit of electrogravitics. In the words of T Valone,

“A short review of the history of electrogravitics has recently been published by Professor Theodore Loder. A working definition, based on the T. Townsend Brown’s 1928 British patent #300,311 and The Gravitics Situation report is “electricity used to create a force that depends upon an object’s mass, similar to gravity”. This is the answer that perhaps should still be used to identify true electrogravitics, which also involves the object’s mass in the force, often with a dielectric. This is also what the “Biefeld-Brown effect” of describes. However, we have seen T. Townsend Brown and his patents evolve over time which Tom Bahder emphasizes. Later on, Brown refers to “electrokinetics” (that partly overlaps the field of electrogravitics), that requires asymmetric capacitors to amplify the force. Therefore, Bahder’s article discusses the lightweight effects of “lifters” and the ion mobility theory found to explain them. Note: electrogravitics (EG) and electrokinetics (EK) are related but different phenomena that are presently the subject of this paper.

To put things in perspective, the article “How I Control Gravitation”, published in 1929 by Brown, presents an electrogravitics-validating discovery about very heavy metal objects (44 lbs. each) separated by a dielectric insulator, charged up to high voltages. T. T. Brown also expresses an experimental formula in words which tell us what he found was directly contributing to the unidirectional force (UDF) which he discovered, moving the system of masses toward the positive charge. He describes the equation for his electrogravitic force to be $F \approx Vm^1m^2/r^2$. However, electrokinetics and electrogravitics also seem to be governed by another Equation (1) when higher order pulsed voltages are utilized. The important fact from Brown’s recorded experiments and lab notes is that the DC power supply was raised substantially up to 250 kV, with a substantial force being displayed starting around 150 kV. Here we get an idea of the range of voltage necessary for successful electrogravitics that even recent military contractors mysteriously disregard. An example is R. L. Talley’s report commissioned by the Air Force and concerned “with exploring the Biefeld-Brown effect which allegedly converts electrostatic energy directly into a propulsive force in a vacuum environment”. It was entitled, “Twenty First Century Propulsion Concept” (#PL-TR-91-3009), but only tested Brown saucer designs in the relatively low range of 19 kV and predictably failed to produce any significant results.”⁶²¹ [sic]

Here we find an interesting hypothesis (or several):

“Classified antigravity technologies have been kept from the public realm for over six decades while secretly developed by military-corporate entities. It was revealed in 1992, for example, that the B-2 Bomber used electrostatic charges on its leading wings and exhaust. According to aerospace experts, this was confirmation that the B-2 used electrogravitic principles based on the “Biefeld-Brown Effect””⁶²²

To make a long story short, the Jefimenko work on Electrokinetics gives the direction of the force vectors, which are possibly essential to electrogravitics. See Figures 96 and 97.

The ultimate factor appears to be the dielectric medium between the plates (or the plate and the ground?) However, that presents some very interesting applications.

⁶²¹ https://www.researchgate.net/publication/275336156_Review_of_Electrogravitics_Electrokinetics_Propulsion

⁶²² Ibid.

3.4. Jefimenko's Electrokinetics

Known for his extensive work with atmospheric electricity, electrostatic motors and electrets, Dr. Oleg Jefimenko deserves significant credit for presenting a valuable theory of the electrokinetic field, as he calls it [20]. A West Virginia University professor and physics purist at heart, he describes this field as the *dragging force* that electrons exert *on neighboring electric charges*. He identifies the electrokinetic field by the vector E_k where

$$E_k = -\frac{1}{4\pi\epsilon_0 c^2} \int \frac{1}{r} \left[\frac{\partial J}{\partial t} \right] dV' \quad (1)$$

It is one of three terms for the electric field in terms of current and charge density. Equations like $F = qE$ also apply for calculating force.

The significance of E_k , as seen in Equation (1), is that the electrokinetic field simply the third term of the classical equation for the electric field:

$$E = \frac{1}{4\pi\epsilon_0} \int \left\{ \frac{\rho}{r^2} + \frac{1}{rc} \frac{\partial \rho}{\partial t} \right\} r dV' + E_k \quad (2)$$

This three-term Equation (2) is a “causal” equation, according to Jefimenko, because it links the electric field E back the electric charge and its motion (current) which induces it. This is the essence of electromagnetic induction, *as James Maxwell intended*, which is measured by, not caused by, a changing magnetic field. The second electric field term, designated as the electrokinetic field, is directed along the current direction or parallel to it. It also exists only as long as the current is changing in time. Lenz' Law is also built into the minus sign. Parallel conductors will produce the strongest induced current.

By examining the vector potential A equation which depends upon the current density J , he finds that E_k can be expressed as the time derivative of A , which leads to

$$A = -\int E_k dt + \text{const} \quad (3)$$

Figure 96 - Jefimenko's Electrokinetics; credit: T Valone, Jefimenko⁶²³

While the issue of Electrokinetics does not **prove** electrogravitics, it does take a major leap forward into defining it mathematically.. Furthermore, this “conspiracy” (which is quite realistic, as the US has been known to hoard patents of technologically sensitive subjects - such as the FBI taking over Tesla's work after his death - see above) would explain the slowdown in commercial application of the technique. (see Figure 98)

It is beyond the scope of this paper to prove or disprove the claims of any fringe study of electromagnetism (let alone electrokinetics), however the author invites the readership to approach the papers with some openness bearing in mind that it is a lab-based legitimate study since at least 1929. Laboratory based study is the key to scientific progress. On top of that, at the time such work began, QM was new, WEM hadn't even been invented, nor had the branch of nuclear physics begun in earnest. That means that TT Brown and similar men were more open - fully open - to possibilities and willing to do experiments, not worried that they could violate the laws of physics⁶²⁴.

⁶²³ Ibid.

⁶²⁴ After all they really can't, so why not try anything to see what happens?

We note that the current is presumed to be the same in each plate but in opposite directions because it is alternating. Using Equation (3), Jefimenko calculates the electrokinetic field, for the AC parallel plate capacitor with current going in opposite directions, as

$$E_k = -\mu_o \frac{\partial I}{\partial t} \frac{x}{w} j \quad (4)$$

Of course, in vector calculus, i , j , and k are the unit vectors for the x , y , z axis directions seen in Figure 3, respectively. It is clearly seen that the y -axis points upward in Figure 3 and so with the minus sign of Equation (3),

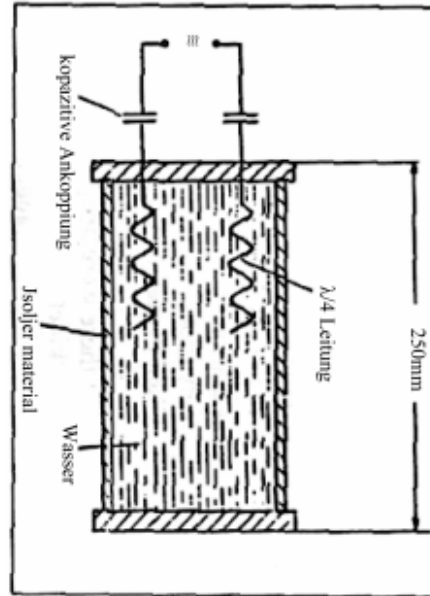

Figure 2. Sample capacitor probe used by Zinsser. Notice the quarter $\lambda/4$ wavelength electrodes which indicate a resonant circuit design.

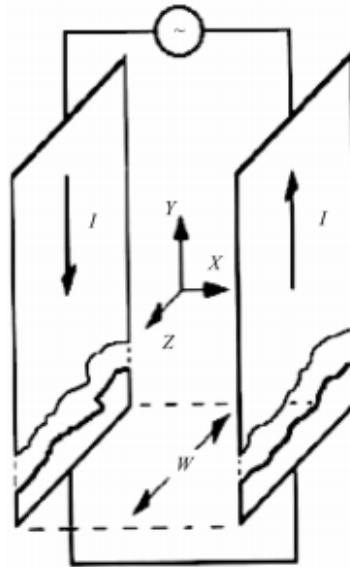

Figure 3. Calculation of Jefimenko's electrokinetic force in the space between two current-carrying plates. X is the space between the plates. W is the width of the plates.

the electrokinetic force for the AC parallel plate capacitor will point downward. Since Zinsser had his torsion balance on display in Toronto in 1981, I was privileged to verify the direction of the force that is created with his quarter-wave plates oriented as they are in Figure 2. The torsion balance is built so that the capacitor probe can only be deflected downward from the horizontal. The electrokinetic force is in the same direction.

Figure 97 - Force Direction in Electrokinetics; credit: T Valone, Jefimenko⁶²⁵

⁶²⁵ Ibid.

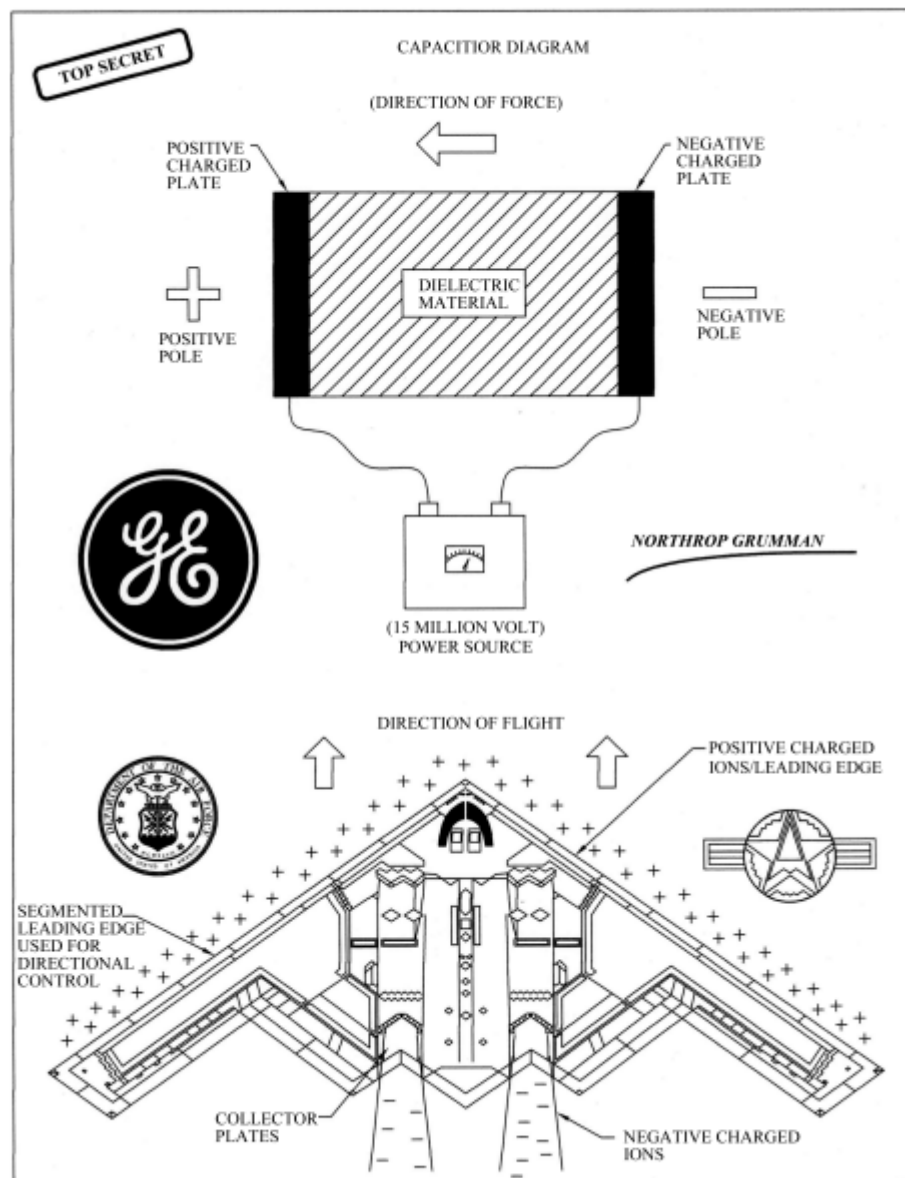

Figure 10. Diagram of Dr. Paul LaViolette's discovery regarding the B-2 auxiliary propulsion system using electrogravitics.

Figure 98 - Stealth Bomber use of Electrokinetics; credit: T Valone, P LaViolette⁶²⁶

Electroweak Force

Strangely enough, one of the more accepted⁶²⁷ improvements to EMF, via QED⁶²⁸, is the eradication of the Weak Force as a separate force for an obviously distance-specific subcategory of the EMF⁶²⁹. Hence the combination into EMF called Electroweak Force⁶³⁰. This simplification is exciting because it is one more step towards a UF!

However, EWF cannot *be* the UAF because it is not comprehensive enough as a concept. Rather, the EWF is folded *into* PEMF, resulting in a proposed UAF=PEM(WG)F. However, this UAF cannot be fully verified

⁶²⁶ Ibid.

⁶²⁷ verily, nearly mainstream!

⁶²⁸ <https://www.britannica.com/science/electroweak-theory>

⁶²⁹ <http://cerncourier.com/cws/article/cern/41013>

⁶³⁰ http://www.sns.ias.edu/~pjl/talks/EWT_3.pdf

until the Strong Force⁶³¹ and the specifics of Electrogravity are worked out in detail⁶³², lab, and astrophysics. Research is ongoing, as EGF has been proposed all the way since the 1800's⁶³³, due to the analogs of the two forces (see Figure 99).

	Electric Field	Gravitational Field
Force (N)	$F = \frac{1}{4\pi\epsilon_0} \frac{Q_1 Q_2}{r^2}$	$F = G \frac{M_1 M_2}{r^2}$
Field strength	$E = \frac{F}{Q} \quad E = \frac{1}{4\pi\epsilon_0} \frac{Q}{r^2}$	$g = \frac{F}{m} \quad g = G \frac{M}{r^2}$
Potential	$V = \frac{1}{4\pi\epsilon_0} \frac{Q}{r}$	$V = -G \frac{M}{r}$
Potential difference	$\Delta V = \frac{\Delta W}{Q}$	$\Delta V = \frac{\Delta W}{M}$
Potential energy or Work done (J)	$W = \frac{1}{4\pi\epsilon_0} \frac{Qq}{r}$	$W = -G \frac{Mm}{r}$

Figure 99 - Electric vs Gravitational Fields; credit: Physbot⁶³⁴

However, the Strong Force may need more work⁶³⁵. As noted above, it is only 1 significant figure smaller in ratio to EMF than the neutron/electron ratio. Quark analysis may reveal a Feynman diagram relationship that, through differential trigonometry solves this ratio discrepancy. Or, perhaps, due to the inverse square rule, the charge ratio (mass) reflects a distance variable that is 10x the relative force strength for another logical reason. It is beyond the scope of this paper to resolve, and the author hopes someone takes the matter up! For now, the forces are seen in the Mainstream as distinct, separate, and tied to proposed Big Bang Cosmological "Expansion" (which is based on inappropriate redshift analysis lacking *intrinsic* redshift.)

⁶³¹ "Grand unification refers to unifying the strong interaction with the unified electroweak interaction. The basic problem of "restoring the broken symmetry" between the strong and electroweak forces is that the strong force works only on colored particles and the leptons don't have color. You have to be able to convert quarks to leptons and vice versa. But this violates the conservation of baryon number, which is a strong experimental nuclear physics principle. Baryon number minus lepton number (B-L) would still be conserved as a quark is changed to an anti-lepton. The required mass of the exchange boson is 10¹⁵ eV, which is more like the mass of a visible dust particle than that of a nuclear entity. This particle is called the X-boson.

One prediction of the grand unified theories is that the proton is unstable at some level.

In the 1970's, Sheldon Glashow and Howard Georgi proposed the grand unification of the strong, weak, and electromagnetic forces at energies above 10¹⁴ GeV. If the ordinary concept of thermal energy applied at such times, it would require a temperature of 10²⁷ K for the average particle energy to be 10¹⁴ GeV."

<http://hyperphysics.phy-astr.gsu.edu/hbase/Forces/unify.html>

⁶³² <http://hyperphysics.phy-astr.gsu.edu/hbase/Forces/einun.html#c1>

⁶³³ O. Heaviside (1893). "A gravitational and electromagnetic analogy". *The Electrician*. **31**: 81–82 <http://sergf.ru/Heavisid.htm>

⁶³⁴ <http://www.physbot.co.uk/electric-fields-and-potentials.html>

⁶³⁵ "The unification of the strong force is well beyond our reach at the present time, and the unification of gravity with the other three is out of reach for earthbound experiments. This has led to greater cooperation between high-energy particle physicists and astrophysicists as each group realizes that some of their answers can only come from the other." Ibid.

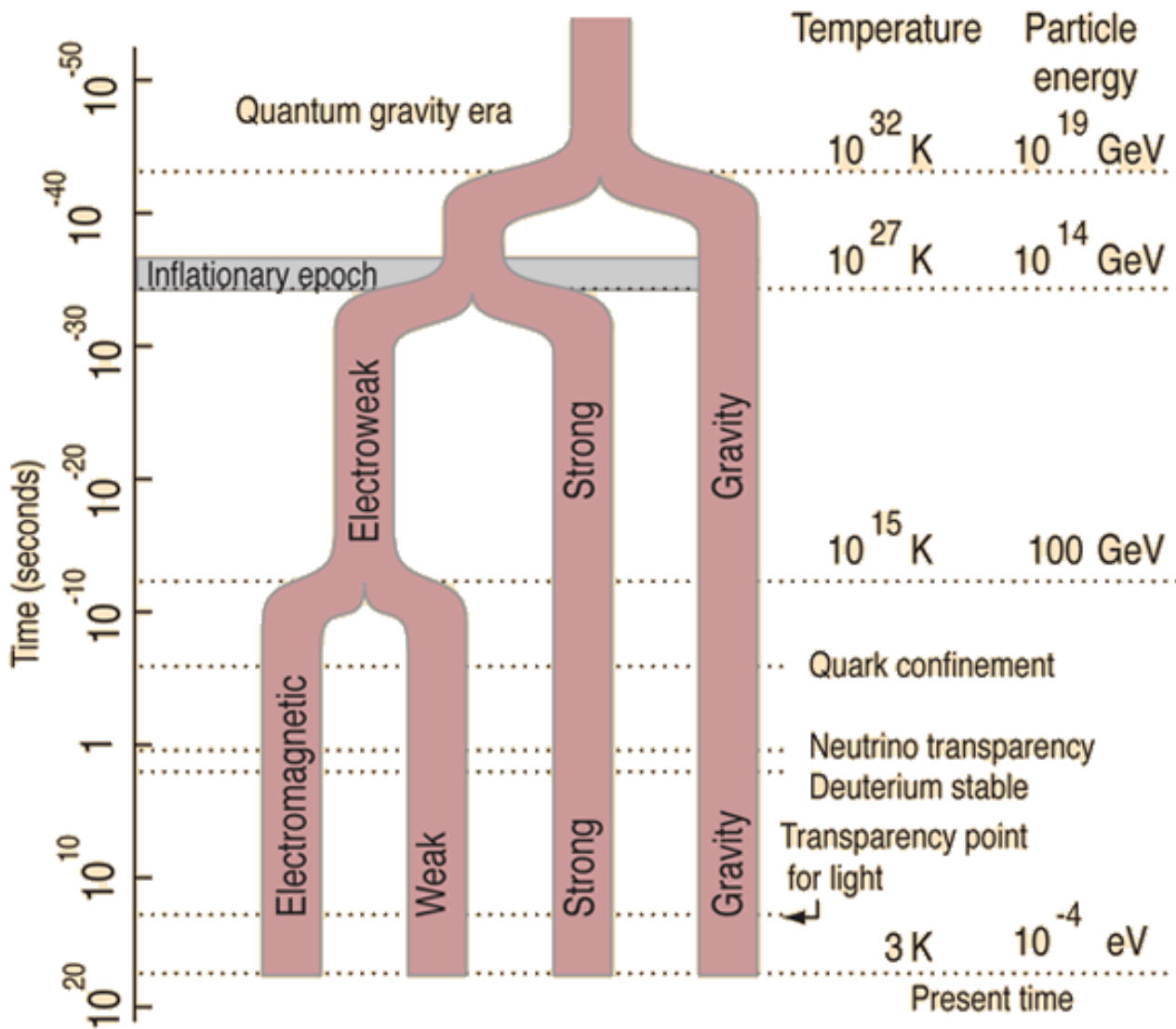

Figure 100 - Force Evolution in Big Bang Cosmology; credit: HyperPhysics⁶³⁶

PEM Force (PEMF)

As has been driven home, and not to berate a point, the author proposes that indeed the Aether is the Electromagnetic Force - the one Force - which includes the other 3 forces, as a matter of scale and differentiation. The Unified Field then is made of an already established Aether Field: (1) classical EMF, (2) NEM, (2) QED, (3) MHD, and (4) plasma physics. The atomic model is not yet complete, but must evolve to reduce, and remain philosophically *sound* (empirical, logical, rational, and intuitively simple).

The point need not be overstated again. Rather, the author would like to point to a solution to the world's energy problems⁶³⁷, and the general search for "free energy"⁶³⁸ which has thus far (excepting perhaps

⁶³⁶ <http://hyperphysics.phy-astr.gsu.edu/hbase/Astro/unify.html#c1>

⁶³⁷ It is clear that mankind's electronics and technology dependence is not going to end, and population still has several billions of people to go.

<https://www.ukessays.com/essays/environmental-sciences/the-future-world-energy-crisis-environmental-sciences-essay.php>

⁶³⁸ Typically mankind has tried to achieve Free Energy via two thermodynamically impossible means: Perpetual Motion (even Leedskalnin fell into this trap), and Cold Fusion (which is inherently endothermic).

https://en.wikipedia.org/wiki/Free_energy

Tesla⁶³⁹ and a few others) remained out of human reach, leaving us to a desolate behavior of burning⁶⁴⁰ our third most precious commodity: fossil fuels⁶⁴¹.

In terms of alternative energy solutions, there are several that the author can imagine, both widely known and not widely known:

1. Solar (photovoltaic and steam)
2. Wind (turbines and kites)
3. Hydroelectric dams and waterfall downspouts
4. Thorium nuclear (far safer than Uranium)
5. Tidal (oceans, great lakes) and River current turbines
6. Standard Geothermal and Geochemical Voltaic Cells
7. Spare wind (such as parking lots, towers, and sides of the highways)
8. Solar Wind (transfer to a moon station, beamed as microwaves back to Earth)
9. Stellar signal collection⁶⁴²
10. Planetoid/Asteroid Charge and fuel harvesting
11. Hurricane/Vortex/Supercell harvest
12. Land faults and volcanoes (certain, very active spots)
13. Piezoelectric farms and Giza-like Earth Resonant + plasma power plants
14. Lightning and Sprite Collection
15. Charge "thermals" (hotspots)

⁶³⁹ <http://www.tfcbooks.com/tesla/1932-07-10.htm>

⁶⁴⁰ "A similar inestimable advantage in the saving of energy available to man would be secured by obviating the great waste of coal which is inseparably connected with the present methods of manufacturing iron. In some countries, such as Great Britain, the hurtful effects of this squandering of fuel are beginning to be felt. The price of coal is constantly rising, and the poor are made to suffer more and more. Though we are still far from the dreaded "exhaustion of the coal-fields," philanthropy commands us to invent novel methods of manufacturing iron, which will not involve such barbarous waste of this valuable material from which we derive at present most of our energy. It is our duty to coming generations to leave this store of energy intact for them, or at least not to touch it until we shall have perfected processes for burning coal more efficiently. Those who are coming after us will need fuel more than we do. We should be able to manufacture the iron we require by using the sun's energy, without wasting any coal at all. As an effort to this end the idea of smelting iron ores by electric currents obtained from the energy of falling water has naturally suggested itself to many. I have myself spent much time in endeavoring to evolve such a practical process, which would enable iron to be manufactured at small cost. After a prolonged investigation of the subject, finding that it was unprofitable to use the currents generated directly for smelting the ore, I devised a method which is far more economical....

"I remember that at one time I considered the production of electricity by burning coal in a battery as the greatest achievement toward the advancing civilization, and I am surprised to find how much the continuous study of these subjects has modified my views. It now seems to me that to burn coal, however efficiently, in a battery would be a mere makeshift, a phase in the evolution toward something much more perfect. After all, in generating electricity in this manner, we should be destroying material, and this would be a barbarous process. We ought to be able to obtain the energy we need without consumption of material. But I am far from underrating the value of such an efficient method of burning fuel. At the present time most motive power comes from coal, and, either directly or by its products, it adds vastly to human energy. Unfortunately, in all the process now adopted, the larger portion of the energy of the coal is uselessly dissipated. The best steam-engines utilize only a small part of the total energy. Even in gas-engines, in which, particularly of late, better results are obtainable, there is still a barbarous waste going on. In our electric-lighting systems we scarcely utilize one third of one per cent., and in lighting by gas a much smaller fraction, of the total energy of the coal. Considering the various uses of coal throughout the world, we certainly do not utilize more than two per cent. of its energy theoretically available. The man who should stop this senseless waste would be a great benefactor of humanity, though the solution he would offer could not be a permanent one, since it would ultimately lead to the exhaustion of the store of material." ~N Tesla <http://www.tfcbooks.com/tesla/1900-06-00.htm>

⁶⁴¹ Fossil fuels is a term partially used here as a legacy, because it is possible that most of the oil came from the Venus comet-tail, as Venus' atmosphere is filled with rare hydrocarbons, as Velikovsky predicted.

<https://www.forbes.com/sites/quora/2017/10/18/is-venus-a-better-place-to-colonize-than-mars/#48af907e5c47>

⁶⁴² Much like photovoltaics, only small amounts could be collected per cell, but multiplied in arrays.

16. Moon tides (kinetic/potential magnetic springs locked with stations on moon; or quantum entanglement)

All of these methods far outstrip the performance of *burning* fuel, which can then be preserved for medical plastics (as most plastics can be manufactured from plant cellulose). The harvesting of the stellar wind and geochemical alone can supply energy for trillions of people on multiple planets. It is the author's opinion that humankind cannot stop being barbaric until they remember or relearn that the accomplishment of peace, throughout, is accomplished via Energy Management.⁶⁴³

When mankind comes to accept that the real Aether is charge (Q)⁶⁴⁴, the real Aether Field is magnetism, that the real Unified Force is electromagnetism in a plasma flux (occasionally condensed into fluids, or crystallized into solids), and mankind comes to accept the reality of past events, then we will be able to easily solve our natural⁶⁴⁵, health⁶⁴⁶, socio-political⁶⁴⁷, and of course, energetic-technoscientific quagmires and conundrums.

Electricity, in conclusion is the harvesting *power* of movement or use of the magnetic field; the shadow of force, and flow, of that magnificent "Cosmic Force" (Leedskalnin), which remains the [secular] guiding power behind everything. The interaction of the various charges, charged bodies, particles, atoms, molecules, luminous (or other energetic) signals, creates the wide array of electric behaviors, from electricity to all the strange forms of electromagnetism, changes in material form/arrangement, and various modes of transfer (such as different forms of plasma discharges⁶⁴⁸).

Polarization is explained as a singular mode, difficult for us to fathom due to our very dualistic nature, and yet is not itself dualistic, but a singular Force witnessed as separated forces, which change in behavior due to scales and arrangements. Yet, the proper understanding of this PEMF will certainly empower and generally enlighten our formation of the EPEMC and a proper cosmogony.

Conclusions

Although much remaining work and research needs be done, mankind has made prodigious progress in the last 250 years. Electricity may truly be a mystical force as it appears to propel evolution both in planetoids having organic compounds wherever there has been demonstrable arc discharge⁶⁴⁹ as well as human progress⁶⁵⁰.

However, mankind has a long ways to go to both align with this mystical force which we only barely understand, as well as to fully harness it to create a balanced, healthy, natural and civilized human environment which respects the needs of mankind (especially the elderly, children, and infirm). We must

⁶⁴³ "As above, so below." Therefore people must begin to deal with the energetic imbalances created within the body, including food systems, inappropriate chemical use, drug use, sugar intake, and use of natural pollutants that change nerve conduction frequencies and cause buildup/stagnation in channels of the body. The attainment of outer energy abundance (which can be used to create boundless caloric intake) will be meaningless or ever dangerous without the correction of the inner). Therefore the author is working towards new medical devices that will utilize Charge understanding as part of medicine.

⁶⁴⁴ Which can literally be an "invisible" point in physics. Electrons are an example: they are incredibly small, and do freely roam about, or congregate. Certain crystal lattices produce an "aura" of Charge which alter human nervous responses (such as at Yosemite). Of course the piezoelectric effect may be at play there.

⁶⁴⁵ Burning of forests, desertification, polluting of oceans, etc...

⁶⁴⁶ Use of poisons (chemicals) to try and control nerves and pain; especially narcotics.

⁶⁴⁷ Biologically, conflict has always extended from a war between competitors for niche resources; the socio-political struggles, from racism to religious war to world war all relates back to the delusional belief in a lack of energy sources. See Appendix B.I.1-4

⁶⁴⁸ Fire, lightning, glow mode, dark mode, cosmic jets, stellar winds, magnetic flux ropes, Birkeland currents, etc....

⁶⁴⁹ Mars, Moon, Ceres, Io

⁶⁵⁰ In those 250 years, western civilization has abandoned government led by state religion, slavery, colonialism, official feudalism, the gold standard, etc... while introducing electric lighting, public plumbing for common classes, Republics, fundamental human rights, women's rights, public literacy and education, the internet, technology, etc...

abandon semantic confusions and biases, and embrace holistic evaluations with historic context and the advantage of hindsight⁶⁵¹.

Nevertheless, progress in plasma research has continued unabated, and plasma cosmology forms the strongest alternative to Big Bang cosmology, which remains full of internal contradictions and inconsistencies, and defies many elements of observed evidence.

This cosmology, however, must rely on a proven, potent, and ubiquitous power source, which only Electromagnetism (and Electro Weak) can fill at all scales, all distances, and with anti-matter as well. Quantum and relativistic research has yielded Quantum Electrodynamics, while power and astrophysics has yielded Magnetohydrodynamics that affirms early plasma physics and astronomy. These models, if reformed with New Electromagnetism, and augmented with improved geometric algebra and curl analysis, will possibly yield finally a Unified Field Theory that confirms the UAF is indeed and finally the Plasma Electromagnetic Force.

Gravity is too weak to be the UF, and its part in Relativity is far overstated, as originally the photoelectric effect and photovoltaic effects were predicted through Lorentzian transformations of Maxwell's Equations, and thus gravity waves were predicted. Not as space-time, which is a misnomer and not at all the Aether as utilized in improper, incompatible Black Hole pseudoscience, but as the natural radiative effect of atomic behavior between masses, which are not a measure of matter volume, but of charge density. Every atom, molecule, and light wave is the interaction of differing electromagnetic bundles, that at the basic level have a quantum sized ripple distance in the magnetic medium.

Light is the excitation of this medium, and light speed is the rate of its induction, and has nothing at all to do with massless mythical particles called photons, though at any rate they remain a useful model shorthand, (as gravitons do for gravity waves).

Magnetism takes a number of fundamental shapes⁶⁵², but its essential nature is relational. Magnetism does not break but rearranges, while electricity flows through magnetism as a response to active excitation. The continual redistribution of charge and energy in general creates a conservation of energy, as it cannot leave the total System, and this accounts for continual renewal of charge separations and discharging. It occurs on all scales, in proportion to the overall size of the body in question, and these electric currents are in no way disputed or completely understood, though they remain nevertheless.

Our Magnetic Universe is fundamentally electric in its behavior and power manifestation, and these two yin/yang powers dominate secular existence, life, success, health, safety, and ultimately human experience. It is time, the author feels, to fully harness the entire Force, rather than remain in barbarism. To quote Tesla,

*"Sir William Crookes has shown in his beautiful invention known as the "radiometer" that rays may produce by impact a mechanical effect, and this may lead to some important revelation as to the utilization of the sun's rays in novel ways. Other sources of energy may be opened up, and new methods of deriving energy from the sun discovered, but none of these or similar achievements would equal in importance the transmission of power to any distance through the medium. I can conceive of no technical advance which would tend to unite the various elements of humanity more effectively than this one, or of one which would more add to and more economize human energy. It would be the best means of increasing the force accelerating the human mass. The mere moral influence of such a radical departure would be incalculable. On the other hand if at any point of the globe energy can be obtained in limited quantities from the ambient medium by means of a self-acting heat-engine or otherwise, the conditions will remain the same as before. Human performance will be increased, but men will remain strangers as they were."*⁶⁵³

⁶⁵¹ In "Investments in Ragnarok" [5] the author reveals research about human resources/money wasted on account of End of the World media and maintenance of "Weapons of the gods" (nukes). Imagine if one were to analyze **all** the wasted energy, emotion, time, fuel, and opportunities from all wars and pointless human conflict!

⁶⁵² Toroidal, spherical, double-bell shaped, unipolar, etc...

⁶⁵³ "On Increasing Human Energy," N Tesla, June 1900 (just before the plasma, QM, and GR movements began)

Appendix A - Glossary of Terms⁶⁵⁴

Active Galactic Nuclei - An active galactic nucleus (AGN) is a compact region at the center of a galaxy that has a much higher than normal luminosity over at least some portion—and possibly all—of the electromagnetic spectrum, with characteristics indicating that the excess luminosity is not produced by stars.

Aether/Ether - a very rarefied and highly elastic substance formerly believed to permeate all space, including the interstices between the particles of matter, and to be the medium whose vibrations constituted light and other electromagnetic radiation.

Alfvénic Magnetism - In magnetohydrodynamics, the Alfvén's theorem, also known as Alfvén's frozen in theorem, states that in a fluid with infinite electric conductivity, magnetic field lines are frozen into the fluid and have to move along with it.

Amplitude - the maximum extent of a vibration or oscillation, measured from the position of equilibrium.

Angular Momentum - the quantity of rotation of a body, which is the product of its moment of inertia and its angular velocity.

Anode - the positively charged electrode by which the electrons leave a device *or* the negatively charged electrode of a device supplying current such as a primary cell.

Anticyclone - a weather system with high atmospheric pressure at its center, around which air slowly circulates in a clockwise (northern hemisphere) or counterclockwise (southern hemisphere) direction.

Antimatter - “molecules formed by atoms consisting of antiprotons, antineutrons, and positrons. Stable antimatter does not appear to exist in our universe.”

Birkeland Current - A Birkeland current is a set of currents that flow along geomagnetic field lines connecting the Earth's magnetosphere to the Earth's high latitude ionosphere. The strength of the Birkeland currents changes with activity in the magnetosphere (e.g. during substorms).

c - The speed of light in vacuum, commonly denoted *c*, is a universal physical constant important in many areas of physics. Its exact value is 299,792,458 metres per second.

Capacitance - the ability of a system to store an electric charge. The ratio of the change in an electric charge in a system to the corresponding change in its electric potential. The SI unit of capacitance is the farad (symbol: **F**), named after the English physicist Michael Faraday. A 1 farad capacitor, when charged with 1 coulomb of electrical charge, has a potential difference of 1 volt between its plates. symbol: **C**

Cathode - the negatively charged electrode by which electrons enter an electrical device *or* the positively charged electrode of an electrical device, such as a primary cell, that supplies current.

Charge - Electric charge is the physical property of matter that causes it to experience a force when placed in an electromagnetic field. There are two types of electric charges; positive and negative (commonly carried by protons and electrons respectively). Like charges repel and unlike attract. SI unit: Coulomb. symbol: **Q**

Charge Density - the electric charge per unit area of a surface, or per unit volume of a field or body.

Coaxial - having a common axis. (of a cable or line) consisting of two concentric conductors separated by an insulator.

Conductivity

Electrical: the degree to which a specified material conducts electricity, calculated as the ratio of the current density in the material to the electric field that causes the flow of current. It is the reciprocal of the resistivity.

Thermal: the rate at which heat passes through a specified material, expressed as the amount of heat that flows per unit time through a unit area with a temperature gradient of one degree per unit distance.

⁶⁵⁴ Sources: Google and Wikipedia, unless otherwise noted.

Convection - the movement caused within a fluid by the tendency of hotter and therefore less dense material to rise, and colder, denser material to sink under the influence of gravity, which consequently results in transfer of heat.

Coriolis Effect - an effect whereby a mass moving in a rotating system experiences a force (the *Coriolis force* ⁶⁵⁵) acting perpendicular to the direction of motion and to the axis of rotation. On the earth, the effect tends to deflect moving objects to the right in the northern hemisphere and to the left in the southern and is important in the formation of cyclonic weather systems.

Counter-rotation/rotating - (of two corresponding or similar moving parts) rotating in opposite directions.

Curvature - the degree to which a curve deviates from a straight line, or a curved surface deviates from a plane.

Cyclone - a system of winds rotating inward to an area of low atmospheric pressure, with a counterclockwise (northern hemisphere) or clockwise (southern hemisphere) circulation; a depression.

Dark Energy - a theoretical hypothetical repulsive force that counteracts gravity and causes the universe to expand at an accelerating rate.

Dark Matter - (in some cosmological theories) non-luminous material that is postulated to exist in space and that could take any of several forms including weakly interacting particles (*cold dark matter*) or high-energy randomly moving particles created soon after the Big Bang (*hot dark matter*).

Diamagnetic - (of a substance or body) tending to become magnetized in a direction at 180° to the applied magnetic field.

Dielectric/Effect - the energy storing capacity of the material (by means of polarization). A common example of a dielectric is the electrically insulating material between the metallic plates of a capacitor.

Diffusion - the intermingling of substances by the natural movement of their particles: "the rate of diffusion of a gas"

Dwarf Star - a star of relatively small size and low luminosity, including the majority of main sequence stars.

e (Euler's Number) - The number e is a famous irrational number, and is one of the most important numbers in mathematics. The first few digits are: 2.7182818; The natural log of e is 1. $\ln(e)=1$

Earthspot - The hypothetical⁶⁵⁶ junction of low pressure zones changing temperatures, with electromagnetic tunnels observed in correlation with sunspot+solar flare activity, or coronal hole activity, depending on charge.

Eigenvector - a vector that when operated on by a given operator gives a scalar multiple of itself.

Electric/current sheet - A current sheet is an electric current that is confined to a surface, rather than being spread through a volume of space.⁶⁵⁷

Electrical Circuit - a path in which electrons from a voltage or current source flow. The point where those electrons enter an electrical circuit is called the "source" of electrons. The point where the electrons leave an electrical circuit is called the "return" or "earth ground".

Electrical Tension - Voltage, electric potential difference, electric pressure or electric tension (formally denoted ΔV or ΔU , but more often simply as **V** or **U**, for instance in the context of Ohm's or Kirchhoff's circuit laws; see Appendix B.IV) is the difference in electric potential between two points.

Electric Field - a region around a charged particle or object within which a force would be exerted on other charged particles or objects. The SI unit of electric field strength is **newtons per coulomb** (N/C) or volts per **meter**(V/m). The force experienced by a very small test charge q placed in a field E in a vacuum is given by $E = F/q$, where F is the force experienced. Symbol: **E**

Electrogravity - a research subject based upon the original work of Nikola Tesla, and hypotheses advanced by Thomas T. Brown and Brown's subsequent extensive experimentation and demonstrations of the effect.

⁶⁵⁵ Please note this is not a real force, and this is not a correct theorem, but is included for thoroughness. See Birkeland, Bagashov

⁶⁵⁶ Sf. Careaga, see "Weatherman's Guide to the Sun," B Davidson, 2017

⁶⁵⁷ <https://phys.org/news/2012-08-thin-current-sheets-space-action.html>

Electromagnetic Force - (EMF) A fundamental force in nature, the electromagnetic force acts between charged particles and is the combination of all electrical and magnetic forces. The electromagnetic force can be attractive or repulsive.

Electronegativity - a measure of how strongly atoms attract bonding electrons to themselves

Electrotropism - a kind of tropism which results in growth or migration of an organism, usually a cell, in response to an exogenous electric field.

Electroquake - Earthquakes induced by the plasma-electromagnetic sky, especially solar coronal holes.⁶⁵⁸

Electroweak Force - relating to or denoting electromagnetic and weak interactions regarded as manifestations of the same interaction.

Energy - power derived from the utilization of physical or chemical resources, especially to provide light and heat or to work machines.

Euler's Formula (see right)

$$e^{ix} = \cos x + i \sin x$$

Evolutionary Theory - The theory of evolution by natural selection, first formulated in Darwin's book "On the Origin of Species" in 1859, is the process by which organisms change over time as a result of changes in heritable physical or behavioral traits.

$$x \rightarrow x \ln b$$

$$e^{i(x \ln b)} = \cos(x \ln b) + i \sin(x \ln b) \\ = b^{ix}$$

Extrapolation - the action of estimating or concluding something by assuming that existing trends will continue or a current method will remain applicable. In mathematics: the extension of a graph, curve, or range of values by inferring unknown values from trends in the known data.

Extrinsic - not part of the essential nature of someone or something; coming or operating from outside.

EZ Water - H₃O₂ is more viscous, more ordered, and more alkaline than regular water (H₂O), and its optical properties are different. The refractive index of EZ water is about 10% higher than ordinary water.⁶⁵⁹ (see: Structured Water)

Flux - In electromagnetism, electric flux is the measure of flow of the electric field through a given area

Force - strength or energy as an attribute of physical action or movement; something that causes a change in the motion of an object. $F=ma$ (SI unit is **N** for Newtons)

Fractals - a curve or geometric figure, each part of which has the same statistical character as the whole. Fractals are useful in modeling structures (such as eroded coastlines or snowflakes) in which similar patterns recur at progressively smaller scales, and in describing partly random or chaotic phenomena such as crystal growth, fluid turbulence, and galaxy formation.

Frequency - the rate at which a vibration occurs that constitutes a wave, either in a material (as in sound waves), or in an electromagnetic field (as in radio waves and light), usually measured per second.

Friction - the resistance that one surface or object encounters when moving over another.

Gaia Hypothesis - the theory, put forward by James Lovelock, that living matter on the earth collectively defines and regulates the material conditions necessary for the continuance of life. The planet, or rather the biosphere, is thus likened to a vast self-regulating organism.

Galactic Electric Circuit - the electric circuit composed of or pertaining to the galactic scales: clusters, globulars, nebulae, dwarf and galactic superstructures.⁶⁶⁰

Gaussian - being or having the shape of a normal curve or a *normal distribution*.

Gravity - the force that attracts a body toward the center of the earth, or toward any other physical body having mass. For most purposes Newton's laws of gravity apply, with minor modifications to take the general theory of relativity into account. (see figure at right)

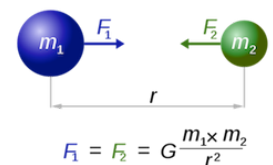

⁶⁵⁸ Sf. Careaga

⁶⁵⁹ www.pollacklab.com

⁶⁶⁰ Sf. Careaga

Gravity Waves - a wave propagated on a liquid surface or in a fluid (Aether) through the effects of gravity.⁶⁶¹

h (Planck's Constant) - the unvarying ratio of the energy of a quantum of radiation to its frequency and that has an approximate value of 6.626×10^{-34} joule-second.

Heavy Water - water in which the hydrogen in the molecules is partly or wholly replaced by the isotope deuterium [a hydrogen isotope], used especially as a moderator in nuclear reactors.

Heisenberg Uncertainty Principle - The statement in quantum mechanics, formulated by Werner Heisenberg, that it is impossible to measure two properties of a quantum object, such as its position and momentum (or energy and time), simultaneously with infinite precision.

Hysteresis (magnetic) - the dependence of the state of a system on its history.

Ideal Gas - a hypothetical gas whose molecules occupy negligible space and have no interactions, and that consequently obeys the gas laws exactly.

Imaginary Number (i) - An imaginary number is a complex number that can be written as a real number multiplied by the imaginary unit i , which is defined by its property $i^2 = -1$

Inductance - the property of an electric conductor or circuit that causes an electromotive force to be generated by a change in the current flowing. (symbol: **L**; Reduced to base SI units, one henry (**H**) is the equivalent of one kilogram meter squared per second squared per ampere squared ($\text{kg m}^2 \text{s}^{-2} \text{A}^{-2}$))

Inertia - a property of matter by which it continues in its existing state of rest or uniform motion in a straight line, unless that state is changed by an external force.

Instant Petrification - rapid organic mineralization via electrolytic ion diffusion in high energy arc discharge⁶⁶²

Intrinsic - belonging naturally; essential.

Intrinsic Redshift - Intrinsic redshift specifically refers to variations in the observed redshift of individual objects (galaxies, quasars ...) that vary from object to object such that two objects at the same distance might have vastly different redshifts.

Ions/Ionized - an atom or molecule with a net electric charge due to the loss or gain of one or more electrons.

Langmuir Probe - a device used to determine the electron temperature, electron density, and electric potential of a plasma. It works by inserting one or more electrodes into a plasma, with a constant or time-varying electric potential between the various electrodes or between them and the surrounding vessel.

Langmuir Waves - Plasma oscillations, also known as Langmuir waves (after Irving Langmuir), are rapid oscillations of the electron density in conducting media such as plasmas or metals in the ultraviolet region. They are parallel in form to *Jeans instability waves*, which are caused by gravitational instabilities in a static medium.

Laplace Transformation - an integral transform named after its discoverer Pierre-Simon Laplace (/ləˈplɑːs/). It takes a function of a real variable t (time) to a function of a complex variable s (frequency). (see right)

$$\begin{aligned}\mathcal{L}\{\sin(at)\} &= F(s) \\ &= \int_0^{\infty} e^{-st} \sin(at) dt \\ &= \lim_{n \rightarrow \infty} \int_0^n e^{-st} \sin(at) dt\end{aligned}$$

Lattice - a regular repeated three-dimensional arrangement of atoms, ions, or molecules in a metal or other crystalline solid.

Lightyear - a unit of astronomical distance equivalent to the distance that light travels in one year, which is 9.4607×10^{12} km (nearly 6 trillion miles).

Liquid Metallic Hydrogen - Metallic hydrogen is a phase of hydrogen in which it behaves like an electrical conductor.

Lorentzian - the set of equations that, in Einstein's special theory of relativity, relate the space and time coordinates of one frame of reference to those of another.

Magnetar - a "neutron" star with an extremely strong magnetic field.

⁶⁶¹ In Einstein's theory of General Relativity, this fluid medium is space-time. In electromagnetic cosmologies, it is the EMF force field itself.

⁶⁶² Sf. Careaga; see: P. Mupp, "Ancient Destructions."

Magnetic Field - a region around a magnetic material or a moving electric charge within which the force of magnetism acts. SI Unit: Gauss. Symbol: **B**

Magnetic Flux - In electromagnetism, the magnetic flux (often denoted Φ or Φ_B) through a surface is the surface integral of the normal component of the magnetic field **B** passing through that surface. The SI unit of magnetic flux is the weber (**Wb**) (in derived units: volt seconds), and the CGS unit is the maxwell.

Magnetic Reconnection - is a physical process in highly conducting plasmas in which the magnetic topology is rearranged and magnetic energy is converted to kinetic energy, thermal energy, and particle acceleration.

Magnetic Flux Ropes - Magnetic flux ropes are twisted bundles of electrical current and magnetic field which can exist in magnetized plasmas⁶⁶³

Magnetosphere - the region surrounding the earth or another astronomical body in which its magnetic field is the predominant effective magnetic field.

Marklund Convection - named after Göran Marklund, is a convection process that takes place in filamentary currents of plasma. It occurs within a plasma with an associated electric field, that causes convection of ions and electrons inward towards a central twisting filamentary axis.

Mass - the property of matter that measures its resistance to acceleration. Roughly, the mass of an object is a measure of the number of atoms in it. The basic unit of measurement for mass is the kilogram (**kg**). (See Newton's laws of motion; compare weight, inertia.)

Membrane - a pliable sheetlike structure acting as a boundary, lining, or partition of various kinds.

Modulation - the process of varying one or more properties of a periodic waveform, called the carrier signal, with a signal that typically contains information to be transmitted.

Momentum - the quantity of motion of a moving body, measured as a product of its mass and velocity. $P=mv$

MOND - a class of theories known as modified gravity, and is an alternative to the hypothesis that the dynamics of galaxies are determined by massive, invisible dark matter halos.

Nebulae - a cloud of gas and dust in outer space, visible in the night sky either as an indistinct bright patch or as a dark silhouette against other luminous matter.

Neutron Star - a [hypothetical] celestial object of very small radius and very high density, composed predominantly of closely packed neutrons.⁶⁶⁴

Nonlinear - In mathematics and physical sciences, a nonlinear system is a system in which the change of the output is not proportional to the change of the input.

Nova/Supernova - a star showing a sudden large increase in brightness and then slowly returning to its original state over a few months.

Ozone Layer - a layer in the earth's stratosphere at an altitude of about 6.2 miles (10 km) containing a high concentration of ozone, which absorbs most of the ultraviolet radiation reaching the earth from the sun.

P-wave - a longitudinal earthquake wave that travels through the interior of the earth and is usually the first conspicuous wave to be recorded by a seismograph. Expand. Also called primary wave.

Penumbra (of the sun) - the less dark outer part of a sunspot, surrounding the dark core.

Period - A Time period (denoted by 'T') is the time needed for one complete cycle of vibration to pass in a given point. As the frequency of a wave increases, the time period of the wave decreases.

Permittivity - the ability of a substance to store electrical energy in an electric field. Symbols: κ , ϵ , ϵ' or ϵ

Pinch - A pinch is the compression of an electrically conducting filament by magnetic forces.

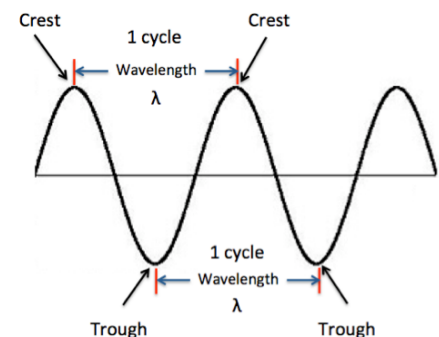

Crest, Trough and Wavelength

⁶⁶³ <http://iopscience.iop.org/article/10.1088/0741-3335/56/6/064002> ; see: Birkeland Currents

⁶⁶⁴ Without any other mechanism of explanation, gravity is expected to be capable of doing this; however, high rotation rates proposed preclude this possibility.

Phi - The Golden ratio ϕ is a special number (1.6180339887) found by dividing a line into two parts so that the longer part divided by the smaller part is also equal to the whole length divided by the longer part.

Photoelectric Effect - the emission of electrons or other free carriers when light shines on a material.

Electrons emitted in this manner can be called photo electrons. This phenomenon is commonly studied in electronic physics, as well as in fields of chemistry, such as quantum chemistry or electrochemistry.

Photovoltaic Effect - the creation of voltage and electric current in a material upon exposure to light and is a physical and chemical property/phenomenon. The photovoltaic effect is closely related to the photoelectric effect.

Photon - a particle representing a quantum of light or other electromagnetic radiation. A photon carries energy proportional to the radiation frequency but has zero rest mass.

Planck Distance/Length - The Planck length is the scale at which classical ideas about gravity and space-time cease to be valid, and quantum effects dominate. This is the quantum of length, the smallest measurement of length with any meaning. And roughly equal to 1.6×10^{-35} m or about 10^{-20} times the size of a proton.

Plasma - an ionized gas consisting of positive ions and free electrons in proportions resulting in more or less no overall electric charge, typically at low pressures (as in the upper atmosphere and in fluorescent lamps) or at very high temperatures (as in stars and nuclear fusion reactors).

Plasma Sheath (aka Double Layer) - The *Debye sheath* (electrostatic sheath) is a layer in a plasma which has a greater density of positive ions, and hence an overall excess positive charge, that balances an opposite negative charge on the surface of a material with which it is in contact. See: Langmuir, Tonks, Bohm⁶⁶⁵

Platonic Solids - one of five regular solids (a tetrahedron, cube, octahedron, dodecahedron, or icosahedron).

Plumes - A mantle plume is an upwelling of abnormally hot rock within the Earth's mantle. As the heads of mantle plumes can partly melt when they reach shallow depths, they are thought to be the cause of volcanic centers known as hotspots and probably also to have caused flood basalts.

Polarized - restrict the vibrations of (a transverse wave, especially light) wholly or partially to one direction.

Power - the rate of doing work, the amount of energy transferred per unit time. In the International System of Units, the unit of power is the joule per second (**J/s**), known as the watt (**W**) in honour of James Watt, the eighteenth-century developer of the steam engine condenser.

Pulsar - a celestial object that emits regular pulses of radio waves and other electromagnetic radiation at rates of up to sixteen thousand pulses per second.

Quanta - a discrete quantity of energy proportional in magnitude to the frequency of the radiation it represents.

Quarks - any of a number of subatomic particles carrying a fractional electric charge, postulated as building blocks of the hadrons. Quarks have not been directly observed, but theoretical predictions based on their existence have been confirmed experimentally. (See right)

Quasar - a massive and extremely remote celestial object, emitting exceptionally large amounts of energy, and typically having a starlike image in a telescope.

Radiation - the emission of energy as electromagnetic waves or as moving subatomic particles, especially high-energy particles that cause ionization.

Radio Jets - An astrophysical jet is an astronomical phenomenon where outflows of ionised matter are emitted as an extended beam along the axis of rotation. When this greatly accelerated matter in the beam approaches the speed of light, astrophysical jets become *relativistic jets* as they show effects from special relativity (see: Relativity Theory).

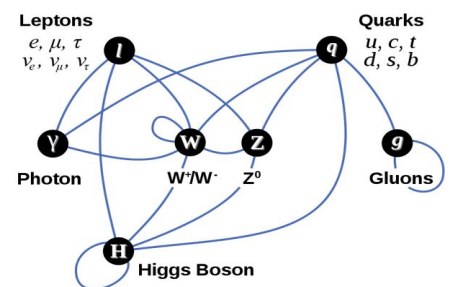

⁶⁶⁵ <http://iopscience.iop.org/article/10.1088/0963-0252/18/1/014004>

Ray Tube - The cathode ray tube (CRT) is a vacuum tube that contains one or more electron guns and a phosphorescent screen, and is used to display images. It modulates, accelerates, and deflects electron beam(s) onto the screen to create the images.

Redshift - the displacement of spectral lines toward longer wavelengths (the red end of the spectrum) in radiation from distant galaxies and celestial objects. This is interpreted as a Doppler shift that is proportional to the velocity of recession and thus to distance.

Relativity Theory - a theory-hypothesis, formulated essentially by Albert Einstein, that all motion must be defined relative to a frame of reference and that space and time are relative, rather than absolute concepts.

Resistivity - a measure of the resisting power of a specified material to the flow of an electric current. $R = V/I$ (see: Ohm's Law, Appendix B.IV.9)

Right-hand Rule - uses the shape the right hand to established the standard orientation of vector quantities normal to a plane, especially when calculating a vector product or the helicity of particle spin. (see right)

Rossby Waves - also known as planetary waves, are a natural phenomenon in the atmosphere and oceans of planets that largely owe their properties to rotation. Rossby waves are a subset of inertial waves. Atmospheric Rossby waves on Earth are giant meanders in high-altitude winds that have a major influence on weather.

Schrödinger's Cat Phenomenon - a cat imagined as being enclosed in a box with a radioactive source and a poison that will be released when the source (unpredictably) emits radiation, the cat being considered (according to quantum mechanics) to be simultaneously both dead and alive until the box is opened and the cat observed.

Schumann Resonances - a set of spectrum peaks in the extremely low frequency (ELF) portion of the Earth's electromagnetic field spectrum. Schumann resonances are global electromagnetic resonances, generated and excited by lightning discharges in the cavity formed by the Earth's surface and the ionosphere.

Solar System Circuit - the electric circuit composed of or pertaining to the solar system scales: the sun, planets, moons, comets, asteroids, and rogue objects, as well as the stellar sheath and boundary region.⁶⁶⁶

Solar Wind - the continuous flow of charged particles from the sun that permeates the solar system.

Space-time - the concepts of time and three-dimensional space regarded as fused in a four-dimensional continuum.

Space-time dilation - the stretching of space-time of a moving object relative to a second stationary observer *or* to differently moving objects in different reference frames.⁶⁶⁷ (see right for time-dilation equation of Special Relativity)

Starwater - a multi-episode literature review of water in the universe, where it comes from, why earth has so much water, and the latest discoveries; water made from solar wind interaction with the Ozone Layer.⁶⁶⁸

String Theory - (aka M Theory) a cosmological theory hypothesis based on the existence of cosmic strings in an 11-dimensional (hypothetical) space-time. See: Supersymmetry

Strong Force - the force that holds particles together in the atomic nucleus and the force that holds quarks together in elementary particles. Note: As the name implies, this is the strongest force known in nature. (see right)

Structured Atom - an atomic theory based upon Platonic solids, electrons, and protons alone; comprising solely of electromagnetic forces (ie; eliminating the strong force)⁶⁶⁹

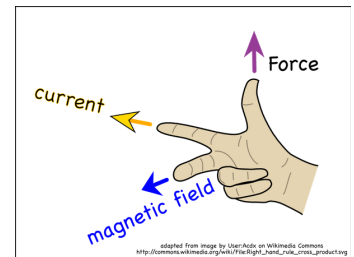

$$t' = t\sqrt{1 - V^2 / c^2}$$

Where: t' = dilated time
 t = stationary time
 V = velocity
 c = speed of light

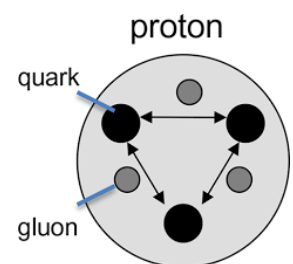

⁶⁶⁶ Sf. Careaga

⁶⁶⁷ Sf. Careaga; <http://www.emc2-explained.info/Time-Dilation/#.Wvopx0gvzrc>

⁶⁶⁸ <https://www.suspicious0bservers.org/starwater/>

⁶⁶⁹ <https://etherealmatters.org/sam>

Structured Water - a molecular arrangement of water molecules that exists when water is near hydrophilic surfaces. (see EZ Water)

Sunspot - a spot or patch appearing from time to time on the sun's surface, appearing dark by contrast with its surroundings.

Supersymmetry - a very general type of mathematical symmetry that relates fermions and bosons.

Surface tension - the tension of the surface film of a liquid caused by the attraction of the particles in the surface layer by the bulk of the liquid, which tends to minimize surface area.

Tau - An arc of a circle with the same length as the radius of that circle subtends an angle of 1 radian. The circumference subtends an angle of 2π radians.⁶⁷⁰ Symbol: τ

Terrella - a small magnetised model ball representing the Earth, that is thought to have been invented by the English physician William Gilbert while investigating magnetism, and further developed 300 years later by the Norwegian scientist and explorer Kristian Birkeland.

Thermodynamics - the branch of physical science that deals with the relations between heat and other forms of energy (such as mechanical, electrical, or chemical energy), and, by extension, of the relationships between all forms of energy.

Tropism - the turning of all or part of an organism in a particular direction in response to an external stimulus.

Tufting - (aka solar granules) when the [solar surface (heliopause)] current density is too high for the anode surface to accommodate, a bright secondary plasma forms within the primary plasma.⁶⁷¹

Unified Field - a type of field theory that allows all that is usually thought of as fundamental forces and elementary particles to be written in terms of a pair of physical and virtual fields.

Vacuum Tube/Crookes Tube - an electron tube containing a near-vacuum that allows the free passage of electric current.

Van Der Waals Forces - weak, short-range electrostatic attractive forces between uncharged molecules, arising from the interaction of permanent or transient electric dipole moments.

Viscosity - the state of being thick, sticky, and semifluid in consistency, due to internal friction or a quantity expressing the magnitude of internal friction, as measured by the force per unit area resisting a flow in which parallel layers unit distance apart have unit speed relative to one another.

Vortex - a mass of whirling fluid or air, especially a whirlpool or whirlwind.

Vortex Algebra - Vortex-matrix Algebra; a subset of linear algebra that postulates the cross product of two vectors is a matrix rather than an orthogonal vector.⁶⁷²

Wave-particle Duality - is the concept in quantum mechanics that every particle or quantic entity may be partly described in terms not only of particles, but also of waves. It expresses the inability of the classical concepts "particle" or "wave" to fully describe the behavior of quantum-scale objects.

Waves - a wave is a disturbance that transfers energy through matter or space, with little or no associated mass transport. Electromagnetic waves do not require a medium.⁶⁷³

Weak Force - the weak interaction (the weak force or weak nuclear force) is the mechanism of interaction between subatomic particles that causes radioactive decay and thus plays an essential role in nuclear fission.

Work - measure of energy transfer that occurs when an object is moved over a distance by an external force at least part of which is applied in the direction of the displacement.

Z Pinch/ Bennett Pinch - also known as a zeta pinch, is a type of plasma confinement system that uses an electrical current in the plasma to generate a magnetic field that compresses it; see: Pinch.

⁶⁷⁰ <https://tauday.com/>

⁶⁷¹ <https://www.everythingselectric.com/electric-sun/>

⁶⁷² Sf. Careaga; see "Votrix Algebra," R. Distinity, 2018

⁶⁷³ A strong hint that they are the medium.

Appendix B - Known Physical Laws of the Universe

I - The Laws of Energy⁶⁷⁴

The laws of energy encompass general statements of known facts about energy, according with studies of the 8 major laws of the Universe: Causality, Evolution/Flux, Relativity, Conservation, Vibration, Rotation, Polarity, and Resonance. To be one of the laws of energy, the axiom must comply with all 8 laws simultaneously (albeit it may appear in different form or applicability), as well as unify the laws, especially their compliments.

1. Energy is abundant; however it prefers wells (sinks) of lowest states of equilibrium.
2. Energy tends to flow along lines of least resistance and highest conductivity; but not always.⁶⁷⁵
3. Energy is produced via differential gradients inducing tension between polarities.
4. Energy is relatively difficult to attain freely.
5. Entropy is balanced with Order, but the ratio between them will affect overall relative appearance of abundance or scarcity of energy.
6. Energy left alone tends to dissipate rather than condensate.
7. Forces bind energy into concentrations and potential reservoirs.
8. Energy may freely transform along prescribed mechanisms and principle controlled means, through forces and fields (force and non-force).
9. Energy conforms to thermodynamic principles in the main, except during reversion or abnormal (forced) circumstances, where it may flow along balancing lines.
10. Energy is neither permanently consumed nor permanently destroyed, it merely transforms, even into quiescent/etheric states which are not directly measured.
11. Energy is.
 - a. The forms of Energy are infinite.
 - b. The time of Energy is eternal.

II - The Laws of Thermodynamics

1. Zeroth law of thermodynamics – If two thermodynamic systems are each in thermal equilibrium with a third, then they are in thermal equilibrium with each other.
2. First law of thermodynamics – Energy can neither be created nor destroyed. It can only change forms. In any process, the total energy of the universe remains the same. For a thermodynamic cycle the net heat supplied to the system equals the net work done by the system.
3. Second law of thermodynamics – The entropy of an isolated system not in equilibrium will tend to increase over time, approaching a maximum value at equilibrium.
4. Third law of thermodynamics – As temperature approaches absolute zero, the entropy of a system approaches a constant minimum.⁶⁷⁶
5. Fourth law of thermodynamics - Intensive properties are independent of the mass of the system; Extensive properties depend on the mass of the system⁶⁷⁷; all equations must balance intensive and extensive properties.⁶⁷⁸

⁶⁷⁴ By Sf. Ramon Careaga, BSEE, MSTOM

⁶⁷⁵ One of the most paradoxical facts regarding the Way/Dao of Energy is this “balancing” clause.

⁶⁷⁶ <http://physicsforidiots.com/physics/thermodynamics/>

⁶⁷⁷ P.T. Landsberg, Thermodynamics with Quantum Statistical Illustrations, Interscience Publishers, New York, 1961, p. 142

⁶⁷⁸ <https://www.youtube.com/watch?v=t8Nm9bnWOTs>

6. Planck's Law - The spectral radiance of a body for frequency ν at absolute temperature T is given by

$$B_{\nu}(T) = \frac{2h\nu^3}{c^2} \frac{1}{e^{\frac{h\nu}{kT}} - 1} \text{ where } k = \text{ Boltzmann's constant}$$

$$= 1.38 \times 10^{-23} \text{ Joules / } ^\circ\text{K} \quad 679 \ 680$$

7. Boyle's Law - The absolute pressure exerted by a given mass of an ideal gas is inversely proportional to the volume it occupies if the temperature and amount of gas remain unchanged within a closed system ⁶⁸¹

8. Ideal Gas Law - The ideal gas law is the equation of state for an ideal gas, given by: $PV=nRT$ where

- P is the pressure
- V is the volume
- n is the amount of substance of the gas (in moles)
- R is the gas constant ($8.314 \text{ J}\cdot\text{K}^{-1}\cdot\text{mol}^{-1}$)
- T is the absolute temperature ⁶⁸²

9. Joule's Gas Law - The internal energy of a fixed mass of an ideal gas depends only on its temperature (not pressure or volume). ⁶⁸³

III - The Laws of Motion and Gravity

1. Newton's First Law - In an inertial frame of reference, an object either remains at rest or continues to move at a constant velocity, unless acted upon by a force.

2. Newton's Second Law - In an inertial reference frame, the vector sum of the forces \mathbf{F} on an object is equal to the mass m of that object multiplied by the acceleration \mathbf{a} of the object: $\mathbf{F} = m\mathbf{a}$. (It is assumed here that the mass m is constant.)

3. Newton's Third Law - When one body exerts a force on a second body, the second body simultaneously exerts a force equal in magnitude and opposite in direction on the first body. ⁶⁸⁴

4. Newton's Law of Gravitation - In non quantum, non-relativistic space,

$$F_g = G \frac{m_1 m_2}{r^2}$$

5. Einstein's General Relativity derivation - In relativistic space, ^{685 686}

6. Euler's First Law - The linear momentum of a body, \mathbf{p} (also denoted \mathbf{G}) is equal to the product of the mass of the body m and the velocity of its center of mass

$$G_{\mu\nu} + \Lambda g_{\mu\nu} = \frac{8\pi G}{c^4} T_{\mu\nu}$$

7. Euler's Second Law - The rate of change of angular momentum \mathbf{L} (sometimes denoted \mathbf{H}) about a point that is fixed in an inertial reference frame (often the mass center of the body), is equal to the sum of the external moments of force (torques) acting on that body \mathbf{M} (also denoted $\boldsymbol{\tau}$ or $\boldsymbol{\Gamma}$) about that point. ⁶⁸⁷

IV - The Laws of Electromagnetism

1. Gauss' Law - The electric flux leaving a volume is proportional to the charge \mathbf{Q} inside.

2. Gauss' Law of Magnetism - There are no magnetic monopoles; the total magnetic flux through a closed surface is zero.

⁶⁷⁹ <https://www.physicsforums.com/threads/plancks-law-wavelength-frequency-angle.788629/>

⁶⁸⁰ $h = \text{Planck's constant, } 6.626070040(81) \times 10^{-34} \text{ J s or } 4.135667662(25) \times 10^{-15} \text{ eV s; such that } E = hf$

⁶⁸¹ https://en.wikipedia.org/wiki/Boyle%27s_law

⁶⁸² https://en.wikipedia.org/wiki/Ideal_gas#Ideal_gas_law

⁶⁸³ https://en.wikipedia.org/wiki/Joule%E2%80%93Thomson_effect#Joule's_second_law

⁶⁸⁴ https://en.wikipedia.org/wiki/Newton%27s_laws_of_motion

⁶⁸⁵ Gravity is not a factor in quantum scales as it is far too weak to be measured and is generally regarded as basically 0.

⁶⁸⁶ Tensors notwithstanding, this law of gravitation will stand until overthrown with something better.

⁶⁸⁷ https://en.wikipedia.org/wiki/Euler%27s_laws_of_motion

3. Faraday's Law of Induction - The voltage induced in a closed loop is proportional to the rate of change of the magnetic flux that the loop encloses.⁶⁸⁸
4. Ampere's Circuit Law - The magnetic field induced around a closed loop is proportional to the electric current plus displacement current (rate of change of electric field) that the loop encloses.⁶⁸⁹
5. Lorentz Force Law - the combination of electric and magnetic force on a point charge due to electromagnetic fields. A particle of charge q moving with velocity \mathbf{v} in the presence of an electric field \mathbf{E} and a magnetic field \mathbf{B} experiences a force:

$$\vec{F} = \underbrace{q\vec{E}}_{\text{Electric force}} + \underbrace{q\vec{v} \times \vec{B}}_{\text{Magnetic force}}$$
6. Lenz's Law - the direction of current induced in a conductor by a changing magnetic field due to induction is such that it creates a magnetic field that opposes the change that produced it.⁶⁹⁰
7. Kirchhoff's First Law of Currents - At any node (junction) in an electrical circuit, the sum of currents flowing into that node is equal to the sum of currents flowing out of that node or the algebraic sum of currents in a network of conductors meeting at a point is zero.
8. Kirchhoff's Second Law of Voltages - The directed sum of the electrical potential differences (voltage) around any closed network is zero, or The algebraic sum of the products of the resistances of the conductors and the currents in them in a closed loop is equal to the total emf available in that loop.⁶⁹¹
9. Ohm's Law - Resistance is defined by the ratio of electrical tension to electrical current; $V = I \cdot R$ ⁶⁹²
10. Ampere's Law with Maxwell's Addition - magnetic fields can be generated in two ways: by electric current and by changing electric fields.⁶⁹³
11. Steinmetz's Law - Hysteresis, lagging of the magnetization of a ferromagnetic material, such as iron, behind variations of the magnetizing field.⁶⁹⁴

V - The Laws of Life⁶⁹⁵

1. The life-force (Q_i)⁶⁹⁶ is mysteriously abundant, but conforms otherwise to the above listed laws.
2. Life orders structure and material, and acts contrariwise to Entropy.
3. All objects follow the pattern: conception, birth, growth, steady state/stagnation, decrease, death, decay, conversion, transformation, re-emergence. This is the *Axiom of Becoming*.
4. Life is found in various modes and scales and conforms to no known pre-set ideals.
5. Life's fundamental elements do not conform to predetermined principles but may spontaneously evolve.
6. Life's balancing principles alternate between (relatively) long-term peaceful or uniform periods and (relatively) short-term violent or sudden (even cataclysmic) periods of forced evolution; the so-called "catch up" phenomenon.
7. Life is. It is neither likely nor unlikely, though it may be influenced into more or less likelihood by the availability of resources.

⁶⁸⁸ https://en.wikipedia.org/wiki/Faraday%27s_law_of_induction

⁶⁸⁹ https://en.wikipedia.org/wiki/Maxwell%27s_equations

⁶⁹⁰ https://en.wikipedia.org/wiki/Lenz%27s_law

⁶⁹¹ https://en.wikipedia.org/wiki/Kirchhoff%27s_circuit_laws

⁶⁹² V=voltage (volts), I = current (amps), R = resistance (ohms)

⁶⁹³ https://en.wikipedia.org/wiki/Amp%C3%A8re%27s_circuital_law

⁶⁹⁴ <https://www.britannica.com/science/hysteresis>

⁶⁹⁵ By Sf. Ramon Careaga, BSEE, MSTOM

⁶⁹⁶ Q_i seems to be related to, but not equivalent with, Charge (Q) in all manners of behavior.

Table of Units, Symbols, and Dimensions

Quantity	Symbol	mks Unit Rationalized	Defining Equation	Dimensional Formula Exponents of				cgs emu	No. of emu No. of mks	cgs esu	No. of esu No. of mks	No. of esu No. of emu
				L	M	T	Q					
1 Length	L	m		1	0	0	0	cm	10^2	cm	10^2	1
2 Area	A	m^2	$A = L^2$	2	0	0	0	cm^2	10^4	cm^2	10^4	1
3 Volume	v	m^3	$v = L^3$	3	0	0	0	cm^3	10^6	cm^3	10^6	1
4 Mass	M, m	kilogram		0	1	0	0	gram	10^3	gram	10^3	1
5 Time	T, t	second		0	0	1	0	second	1	second	1	1
6 Velocity	v	m / sec	$v = L / T$	1	0	-1	0	cm / sec	10^2	cm / sec	10^4	1
7 Acceleration	q	m / sec ²	$a = L / T^2$	1	0	-2	0	cm / sec ²	10^2	cm / sec ²	10^2	1
8 Force	F	newton	$F = Ma$	1	1	-2	0	dyne	10^5	dyne	10^5	1
9 Energy	W	joule	$W = FL$	2	1	-2	0	erg	10^7	erg	10^7	1
10 Power	P	watt	$P = W / T$	2	1	-3	0	erg / sec	10^7	erg / sec	10^7	1
11 Charge	Q, q	coulomb	$F = Q^2 / (4\pi\epsilon_0 L^2)$	0	0	0	1	abcoumb	10^1	statcoulomb	10c	100c
12 Dielectric constant of free space	ϵ_0	farad / m	$\epsilon_0 = 1 / (\mu_0 c^2)$	-3	-1	2	2			1	$4\pi c^2 / 10^7$	
13 Dielectric constant relative	ϵ, ϵ_r	farad / m, numeric	$\epsilon_r = \epsilon / \epsilon_0$	-3	-1	2	2				1	
14 Charge density volume	ρ	coulomb / m ³	$\rho = Q / v$	-3	0	0	1	abcoumb / cm ³	10^{-7}	statcoulomb / cm ³	$c / 10^3$	100c
15 Charge density surface	ρ_s	coulomb / m ²	$\rho_s = Q / A$	-2	0	0	1	abcoumb / cm ²	10^{-5}	statcoulomb / cm ²	$c / 10^3$	100c
16 Charge density line	ρ_l	coulomb / m	$\rho_l = Q / L$	-1	0	0	1	abcoumb / cm	10^{-3}	statcoulomb / cm	$c / 10$	100c
17 Electric intensity	E	volt / m	$E = F / Q = -V / L$	1	1	-2	-1	abvolt / cm	10^6	statvolt / cm	$10^4 / c$	1 / (100c)
18 Electric flux density	D	coulomb / m ²	$D = \epsilon E = \psi / A$	-2	0	0	1		$4\pi / 10^5$		$4\pi c / 10^3$	100c
19 Electric flux	ψ	coulomb	$\psi = DA$	0	0	0	1		$4\pi / 10$		$4\pi 10c$	100c
20 Electric potential	V	volt	$V = -EL$	2	1	-2	-1	abvolt	10^6	statvolt	$10^6 / c$	1 / (100c)
21 EMF	V_g	volt	$V_g = -d\phi / dt$	2	1	-2	-1	abvolt	10^6	statvolt	$10^6 / c$	1 / (100c)
22 Capacitance	C	farad	$C = Q / V$	-2	-1	2	2	abfarad	10^9	statfarad	$c^2 / 10^3$	(100c) ²
23 Current	I, i	ampere	$I = Q / T$	0	0	-1	1	abampere	10^1	statampere	10c	100c
24 Current density	J	ampere / m ²	$J = I / A$	-2	0	-1	1	abampere / cm ²	10^{-5}	statampere / cm ²	$c / 10^3$	100c
25 Resistance	R	ohm	$R = V / I$	2	1	-1	-2	abohm	10^9	statohm	$10^9 / c^2$	1 / (100c) ²
26 Resistivity	ρ	ohm-m	$\rho = RA / L$	3	1	-1	-2	abohm-cm	10^{11}	statohm-cm	$10^7 / c^2$	1 / (100c) ²
27 Conductance	G	mho	$G = 1 / R$	-2	-1	1	2	abmho	10^{-9}	statmho	$c^2 / 10^3$	(100c) ²
28 Conductivity	σ	mho / m	$\sigma = 1 / \rho = J / E$	-3	-1	1	2	abmho / cm	10^{-11}	statmho / cm	$c^2 / 10^7$	(100c) ²
29 Electric polarization	P	coulomb / m ²	$P = D - \epsilon_0 E = \rho L$	-2	0	0	1	abcoumb / cm ²	10^{-5}	statcoulomb / cm ²	$c / 10^3$	100c
30 Electric susceptibility	χ_e	farad / m	$\chi_e = P / E = \epsilon_0(\epsilon_r - 1)$	-3	-1	2	2			1	$4\pi c^2 / 10^7$	
31 Electric dipole moment	m_e	coulomb-m	$m_e = QL$	1	0	0	1			statcoulomb-cm	$10^3 c$	
32 Electric energy density	ω_e	joule / m ³	$\omega_e = DE / 2$	-1	1	-2	0	erg / cm ³	1	erg / cm ³	10	1

Quantity	Symbol	mks Unit Rationalized	Defining Equation	Dimensional Formula Exponents of				cgs emu	No. of emu No. of mks	cgs esu	No. of esu No. of mks	No. of esu No. of emu
				L	M	T	Q					
34 Permeability of free space	μ_0	henry / m	$\mu_0 = 4\pi / 10^7$	1	1	0	-2		$10^7 / 4\pi$			
35 Permeability	μ	henry / m	$\mu = B / H$	1	1	0	-2					
36 relative	μ_r	numeric	$\mu_r = \mu / \mu_0$	0	0	0	0		1			
37 Magnetic pole	p	weber	$p = A(B - B_0)$	2	1	-1	-1	pole = maxwell / 4π	$10^3 / 4\pi$			
38 Magnetic moment	m	weber-m	$m = pL$	3	1	-1	-1	pole-cm	$10^{10} / 4\pi$			
39 Magnetic intensity	H	ampere / m or newton / weber	$H = U / L$ or F / p	-1	0	-1	1	oersted or gilbert / cm	$4\pi / 10^3$			
40 Magnetic flux density	B	weber / m ²	$B = \mu H = \phi / A$	0	1	-1	-1	gauss or maxwell / cm ²	10^4			
41 Magnetic flux	ϕ	weber	$\phi = BA = V_g T$	2	1	-1	-1	maxwell	10^8			
42 Magnetic potential	U	ampere	$U = \mathcal{F} = HL$	0	0	-1	1	gilbert	$4\pi / 10$			
43 MMF	\mathcal{F}	ampere	$\mathcal{F} = I$	0	0	-1	1	gilbert	$4\pi / 10$			
44 Intensity of magnetization	M	weber / m ²	$M = B - B_0 = m / L^3$	0	1	-1	-1	pole / cm ² or gauss / 4π	$10^4 / 4\pi$			
45 self Inductance	L	henry	$L = \phi / I$	2	1	0	-2	abhenry	10^9		$10^3 / c^2$	1 / (100c) ²
46 mutual Inductance	M	henry	$M = \phi / I = W / P$	2	1	0	-2	abhenry	10^9		$10^3 / c^2$	1 / (100c) ²
47 Reluctance	\mathcal{R}	ampere / weber	$\mathcal{R} = \mathcal{F} / \phi$	-2	-1	0	2					
48 Reluctivity	v	meter / henry	$v = 1 / \mu$	-1	-1	0	2					
49 Permeance	\mathcal{P}	weber / amp	$\mathcal{P} = 1 / \mathcal{R}$	2	1	0	-2					
50 Permittivity	μ	henry / meter	$\mu = 1 / v$	1	1	0	-2					
51 EMF	V_g	volt	$V_g = -d\phi / dt$	2	1	-2	-1	abvolt	10^6	statvolt	$10^6 / c$	1 / (100c)
52 Poynting's vector	\mathcal{P}	watts / m ²	$\mathcal{P} = EH$	0	1	-3	0	abwatt / cm ²	10^3	statwatt / cm ²	10^3	1
53 Magnetic energy density	ω_m	joule / m ³	$\omega_m = HB / 2$	-1	1	-2	0	erg / cm ³	10	erg / cm ³	10	1
54 Magnetic susceptibility	χ_m	henry / m	$\chi_m = M / H = \mu_0(\mu_r - 1)$	1	1	0	-2	henry / m	$10^7 / 4\pi$			

$\mu_0 = 4\pi / 10^7$ henrys / m. For $c = 2.998 \times 10^8$ meters / sec, $\epsilon_0 = 1 / \mu_0 c^2 = 10^7 / (4\pi c^2) = 8.854 \times 10^{-12}$ farad / meter
 For $c \sim 3 \times 10^8$ meters / sec, $\epsilon_0 \sim 1 / (36\pi 10^6)$ farad / meter
 $c^2 = 8.988 \times 10^{16} \sim 9 \times 10^{16}$

Table 15 - SI Units in Physics; credit: E Dollard⁶⁹⁷

Appendix C - References

1. "Extended Plasma-electromagnetic Cosmology", Sf. R. Careaga, 2018
2. "On the Origins of Religions", Sf. R. Careaga, 2018
3. "Unboxing Atlantis", Sf. R. Careaga, 2018
4. "Plasma-Electromagnetic Sky", Sf. R. Careaga, 2018
5. "Investments in Ragnarok", Sf. R. Careaga, 2018
6. "South-pointing chariot", Wiki, https://en.wikipedia.org/wiki/South-pointing_chariot
7. "The Origins Of W. Gilbert's Scientific Method," E. Zilsel, 1941, <https://web.archive.org/web/20140714194058/http://philoscience.unibe.ch/documents/MaterialHS11/PSWissRev/Zilsel1941.pdf>
8. "William Gilbert (astronomer)", Wiki, [https://en.wikipedia.org/wiki/William_Gilbert_\(astronomer\)](https://en.wikipedia.org/wiki/William_Gilbert_(astronomer))
9. "The Birkeland Terrella," T. Brundtland, 1997-1998, <http://www.mhs.ox.ac.uk/sphaera/index.htm?.issue7/articl6>
10. "Kite Experiment," Wiki, https://en.wikipedia.org/wiki/Kite_experiment
11. "Electromagnetic Unification," A. Belendez, 2015, <https://metod.org/issues/article-revistas/electromagnetic-unification.html>
12. "Nikola Tesla," History Channel, 2018, <https://www.history.com/topics/inventions/nikola-tesla>
13. "Introducing Electric Fields," J. Roche, 2016, <http://iopscience.iop.org/article/10.1088/0031-9120/51/5/055005/meta>
14. "The Electric Field in Various Circumstances," M. Gottlieb and R. Pfeiffer, 2013, http://www.feynmanlectures.caltech.edu/II_07.html
15. "The Plasma Universe of Hannes Alfvén," D. Talbott, 2011, <http://coincider.com/wp-content/uploads/2014/10/edgescience-09.pdf>
16. "Is Feynman's Analysis of Electrostatic Screening Correct? K.Subbarao and S. Mahajan, <https://arxiv.org/ftp/arxiv/papers/1609/1609.05567.pdf>
17. "Magnetic Current," E. Leedskalnin, 1945, <http://www.leedskalnin.com/Leedskalnins-Writings-MAGNETIC-CURRENT.html>
18. "The jets of AGN as giant coaxial cables," D. C. Gabuzda et al., 2017, <https://arxiv.org/pdf/1712.08414.pdf>
19. "Researchers clarify dynamics of black hole rotational energy," MIPT, 2018, <https://phys.org/news/2018-02-dynamics-black-hole-rotational-energy.html>
20. "Hawking Radiation of Black Rings from Anomalies, B. Chen, W. He, 2007, <https://arxiv.org/pdf/0705.2984.pdf>
21. "Frozen magnetic flux. Magneto-acoustic waves," Chen, http://sun.stanford.edu/~sasha/PHYS780/PLASMA_PHYSICS/phys780_2014_I21.pdf
22. "Flux Freezing," R. Fitzpatrick, 2011, <https://farside.ph.utexas.edu/teaching/plasma/lectures1/node64.html>
23. "Alfvén's Theorem," Wiki, https://en.wikipedia.org/wiki/Alfv%C3%A9n%27s_theorem
24. "On frozen-in field lines and field-line reconnection," Journal of Geophysical Research, 1976, <https://agupubs.onlinelibrary.wiley.com/doi/full/10.1029/JA081i022p04019>
25. "Electric Currents from Space," Dr. D. Stern, 2006, <https://www-spf.gsfc.nasa.gov/Education/wcurrent.html>
26. "Parallel electric field generation by Alfvén wave turbulence," N.Bian et al, 2010, <https://arxiv.org/abs/1006.2662>
27. "Scientists create never-before-seen form of matter," Harvard University, 2013, <https://phys.org/news/2013-09-scientists-never-before-seen.html>
28. "Uncovering the Missing Secrets of Magnetism." K. Wheeler, 2014, <https://ia802502.us.archive.org/31/items/magnetism1small/magnetism1small.pdf>
29. "What is the origin of zero? How did we indicate nothingness before zero?" R.Kaplan, 2000, <https://www.scientificamerican.com/article/what-is-the-origin-of-zero/>
30. "Double-slit experiment." Wiki, https://en.wikipedia.org/wiki/Double-slit_experiment
31. "The Atomic Project: Leedskalnin's Atom," E. Leedskalnin, <http://www.leedskalnin.com/LeedskalninsPMH-CommonCoreConcept.html>
32. "A question on the unification of electricity and magnetism," Stack Exchange, 2017, <https://physics.stackexchange.com/questions/309271/a-question-on-the-unification-of-electricity-and-magnetism>
33. "Anatomy of an Electromagnetic Wave," NASA, 2016, https://science.nasa.gov/ems/02_anatomy
34. "Improving Students' Understanding of Magnetism, C. Singh, <https://arxiv.org/ftp/arxiv/papers/1701/1701.01523.pdf>
35. "Lodestone." Wiki. <https://en.wikipedia.org/wiki/Lodestone>

36. "Lodestone 600 BC," Magnetic Academy, 2014, <https://nationalmaglab.org/education/magnet-academy/history-of-electricity-magnetism/museum/lodestone>
37. "Baghdad Battery," Wiki, https://en.wikipedia.org/wiki/Baghdad_Battery
38. "Was There An Explosion In The Great Pyramid In Antiquity?" S. Mehler, <http://www.gizapyramid.com/stephen%20mehler%20research%20article.htm>
39. "Magnets," 2015, <http://www.magnetipupin.com/magnets/>
40. "Loadstone and Magnetic Bodies," W. Gilbert, 1893, <http://www.lancaster.ac.uk/fass/projects/gilbert/docs/onloadstonemagne00gilbuoft.pdf>
41. "The History of Magnetic Therapy," Natural Magnetism, <https://www.naturalmagnetism.com/history-of-magnetic-therapy>. <https://www.naturalmagnetism.com/history-of-magnetic-therapy.html>
42. "Timeline," Magnet Academy, 2012, <https://nationalmaglab.org/education/magnet-academy/history-of-electricity-magnetism/timeline>
43. "Dark Matter's Rival: Ether Theory Challenges 'Invisible Mass'" E. Svoboda, 2006, <https://news.nationalgeographic.com/news/2006/09/060908-dark-matter.html>
44. "The History of the Aether Theory," C. Ranzan, 2016, <http://www.cellularuniverse.org/AA3AetherHistory.htm>
45. "The Five Elements: Ether in Ayurveda," M. Halpern, MD, <http://www.ayurvedacollege.com/articles/drhalpern/ether>
46. "Science and the Existence of Ether," D. Storoy, 2014, <https://www.scienceandnonduality.com/science-and-the-existence-of-ether/>
47. "Classical Element," Wiki, <https://www.scienceandnonduality.com/science-and-the-existence-of-ether/>
48. "Aether (classical element)," Wiki, [https://en.wikipedia.org/wiki/Aether_\(classical_element\)](https://en.wikipedia.org/wiki/Aether_(classical_element))
49. "Aether (mythology)," Wiki, [https://en.wikipedia.org/wiki/Aether_\(mythology\)](https://en.wikipedia.org/wiki/Aether_(mythology))
50. "Wisdom and foresight in Chinese thought: sensing the immediate future," D. Simandan, 2018, https://www.academia.edu/35438996/Wisdom_and_foresight_in_Chinese_thought_sensing_the_immediate_future_2018
51. "Tidescapes: notes on a Shi (勢)- inflected social science," J. Law & W. Lin, 2017, <http://www.heterogeneities.net/publications/LawLin2017TidescapesNotesOnAShiInflectedSocialScience.pdf>
52. "Criticism of the theory of relativity," Wiki, https://en.wikipedia.org/wiki/Criticism_of_the_theory_of_relativity#A_Hundred_Authors_Against_Einstein
53. "Wal Thornhill as 'heretic pioneer'," Plasmatic, 2008, <http://www.thunderbolts.info/forum/phpBB3/viewtopic.php?f=8&t=535>
54. "Etymology of the Ideogram Dao," A. Chan-Wyles, 2014, <https://icbi.weebly.com/etymology-of-the-ideogram-Isquodaorsquo.html>
55. "Tao Te Ching," D. Lin, <https://www.taoism.net/ttc/chapters/chap01.htm>
56. "Michelson–Morley experiment," Wiki, https://simple.wikipedia.org/wiki/Michelson%E2%80%93Morley_experiment
57. "Electromagnetic radiation," Wiki, https://en.wikipedia.org/wiki/Electromagnetic_radiation
58. "Superconductivity," Wiki, <https://en.wikipedia.org/wiki/Superconductivity>
59. "What Are the 5 Emergent Properties of Water?," C. Carney, 2018, <https://sciencing.com/5-emergent-properties-water-8622128.html>
60. "NIST team proves 'spooky action at a distance' is really real," NIST, 2015, <https://phys.org/news/2015-11-nist-team-spooky-action-distance.html>
61. "Antimatter," Wiki, <https://en.wikipedia.org/wiki/Antimatter>
62. "10 Unusual States Of Matter," Z. Brasier, 2015, <https://listverse.com/2015/08/03/10-unusual-states-of-matter/>
63. "Magnetic monopole," Wiki, https://en.wikipedia.org/wiki/Magnetic_monopole
64. "Pattern Recognition," M. Mozina, 2017, <http://www.thunderbolts.info/forum/phpBB3/viewtopic.php?f=3&t=16599&sid=ed73ff128606a33b0058fbc5f271b02e&start=15>
65. "Magnetism," Wiki, <https://en.wikipedia.org/wiki/Magnetism>
66. "Electromagnetic interference," Wiki, https://en.wikipedia.org/wiki/Electromagnetic_interference
67. "Microstrip – Quarter-wave Transformer," CST, <https://www.cst.com/academia/examples/quarter-wave-transformer>
68. "Birkeland Currents: A Force-Free Field-Aligned Model," D. Scott, 2015, <http://www.ptep-online.com/2015/PP-41-13.PDF>
69. "Measurements of the Electric Current in a kpc scale jet," P.P. Kronberg et al, 2011, <http://iopscience.iop.org/article/10.1088/2041-8205/741/1/L15/pdf>

70. "What is Magnetic Flux?" F. Purba, 2016, <https://www.khanacademy.org/science/physics/magnetic-forces-and-magnetic-fields/magnetic-flux-faradays-law/a/what-is-magnetic-flux>
71. "A Bit About Electric and Magnetic Fields," T. McCarthy, <http://www.thomasgmccarthy.com/an-introduction-to-collider-physics-v/>
72. "Magnetism," Kate M. Wyzant, <https://www.wyzant.com/resources/lessons/science/physics/magnetism>
73. "Radio Wave," Wiki, https://en.wikipedia.org/wiki/Radio_wave#Discovery_and_exploitation
74. "List of things named after Carl Friedrich Gauss," Wiki, https://en.wikipedia.org/wiki/List_of_things_named_after_Carl_Friedrich_Gauss
75. "Carl Friedrich Gauss," Wiki, https://en.wikipedia.org/wiki/Carl_Friedrich_Gauss#Appraisal
76. "Faraday's law of induction," Wiki, https://en.wikipedia.org/wiki/Faraday%27s_law_of_induction
77. "An Analysis of Universality in Blackbody Radiation," P. Robitaille, 2005, <https://arxiv.org/abs/physics/0507007>
78. "Blackbody Radiation and the Carbon Particle," P. Robitaille, 2008, <http://www.ptep-online.com/2008/PP-14-07.PDF>
79. "Blackbody Radiation and the Loss of Universality: Implications for Planck's Formulation and Boltzman's Constant," P. Robitaille, 2009, https://www.researchgate.net/publication/26842355_Blackbody_Radiation_and_the_Loss_of_Universality_Implications_for_Planck's_Formulation_and_Boltzman's_Constant
80. "Climate Oscillations (MJO, ENSO & PDO), considered with validation of Earth Endogenous Energy Theory," B. Leybourne, http://worldnpa.org/wp-content/uploads/2015/06/Leybourne_Gregori_NPAproceedings_2014.pdf
81. "The Solar System as Electrical Transformer," M. Clarage, 2016, <http://mclarage.blogspot.com/2016/08/the-solar-system-as-electrical.html>
82. "Ralph Juergens," Everything Electric, 2015, <https://www.everythingselectric.com/ralph-juergens/>
83. "The Electronic Sun," D. Scott, <https://electric-cosmos.org/Electronic%20Sun.pdf>
84. "Oliver Heaviside," Wiki, https://en.wikipedia.org/wiki/Oliver_Heaviside
85. "Charles Proteus Steinmetz," Edison Tech Center, <http://www.edisontechcenter.org/CharlesProteusSteinmetz.html>
86. "The Rise and Fall of Nikola Tesla and his Tower," G. King, 2013, <https://www.smithsonianmag.com/history/the-rise-and-fall-of-nikola-tesla-and-his-tower-11074324/>
87. "List of Nikola Tesla patents," Wiki, https://en.wikipedia.org/wiki/List_of_Nikola_Tesla_patents
88. "Nikola Tesla's Autobiography," N. Tesla http://www.tfcbooks.com/e-books/my_inventions.pdf
89. "Charles Steinmetz Electrifies the Modern World," C. Poladian, 2018, <http://now.northropgrumman.com/charles-steinmetz-electrifies-the-modern-world/>
90. "Tesla's oscillator," Wiki, https://en.wikipedia.org/wiki/Tesla%27s_oscillator
91. "9 Things You may not know about Nikola Tesla," N. Barksdale, 2014, <https://www.history.com/news/9-things-you-may-not-know-about-nikola-tesla>
92. "Tesla's favorite pigeon dies, 1922," Nikola Tesla's Timeline; Tesla Universe, <https://teslauniverse.com/nikola-tesla/timeline/1922-teslas-favorite-pigeon-dies#goto-310>
93. "Summation of Tesla's Dynamic Theory of Gravity," W. R. Lyne, <http://www.netowne.com/technology/important/>
94. "Charles Steinmetz: Master of Electricity," J. Stein, 2013, https://granderiver.owschools.com/media/orla06_ccss_2016/2/charles_steinmetz_master_of_electricity.pdf
95. "Lifting the Veil on Black Aurorae," R. Irion, 2001, <http://www.sciencemag.org/news/2001/12/lifting-veil-black-aurorae>
96. "Marklund convection," Everything Electric, 2015, <https://www.everythingselectric.com/marklund-convection/>
97. "Why Our Galaxy's Black Hole Didn't Eat That Mystery Object," D.News, 2014, <https://www.seeker.com/why-our-galaxys-black-hole-didnt-eat-that-mystery-object-1769260654.html>
98. "NASA's Chandra Helps Confirm Evidence of Jet in Milky Way's Black Hole," B. Boen, 2017, NASA, https://www.nasa.gov/mission_pages/chandra/news/high-energy-particles-in-milky-way.html
99. "Astronomers Surprised: Stars Born Near Black Hole," B. Carey, 2005, <https://www.space.com/1670-astronomers-surprised-stars-born-black-hole.html>
100. "The centre of our galaxy may be swarming with 10,000 black holes," A. Mann, 2018, <https://www.newscientist.com/article/2165505-the-centre-of-our-galaxy-may-be-swarming-with-10000-black-holes/>
101. "Wasp 104-B Is Darker than Charcoal," T. Moncik et al, 2018, <https://arxiv.org/pdf/1804.05334.pdf>
102. "Henri Poincaré," Wiki, https://en.wikipedia.org/wiki/Henri_Poincar%C3%A9
103. "Mileva Marić," Wiki, https://en.wikipedia.org/wiki/Mileva_Mari%C4%87#Debate_over_collaboration_with_Einstein
104. "Gravitational Wave," Wiki, https://en.wikipedia.org/wiki/Gravitational_wave

105. "Electromagnetic mass," Wiki, https://en.wikipedia.org/wiki/Electromagnetic_mass
106. "Three- Body Problem," Wiki, https://en.wikipedia.org/wiki/Three-body_problem
107. "Poincaré map, Wiki, https://en.wikipedia.org/wiki/Poincar%C3%A9_map
108. "Homotopy groups used in physics," <http://felix.physics.sunysb.edu/~abanov/Teaching/Spring2009/Notes/abanov-cpA1-upload.pdf>
109. "Gustav Kirchhoff." Wiki, https://en.wikipedia.org/wiki/Gustav_Kirchhoff
110. "The Earth's Electrical Environment," https://drive.google.com/file/d/0ByRZ_FN_vit_b3AzSEIPblAxbE0/view
111. "A Re-examination of Kirchhoff's Law of Thermal Radiation in Relation to Recent Criticisms: Reply." P. Robitaille, 2016, <http://www.ptep-online.com/2016/PP-46-04.PDF>
112. "Rotor(electric)," Wiki, [https://en.wikipedia.org/wiki/Rotor_\(electric\)](https://en.wikipedia.org/wiki/Rotor_(electric))
113. "Kirchhoff's Law of thermal Emission is a cornerstone of physics, but it is false,". T. Barnaby, 2015, <http://www.rationalskepticism.org/pseudoscience/kirchhoff-s-law-of-thermal-emission-invalid-t48606.html>
114. "Pierre-Marie Robitaille," Rational Wiki, https://rationalwiki.org/wiki/Pierre-Marie_Robitaille
115. "Kirchhoff's Law Proven Invalid, The Implications Are Enormous," M. Suede, 2014, <https://www.libertariannews.org/2014/04/04/kirchhoffs-law-proven-invalid-the-implications-are-enormous/>
116. "Birkeland Currents: A Force-Free Field-Aligned Model," D. Scott, 2015, <http://www.ptep-online.com/2015/PP-41-13.PDF>
117. "Electrical Circuit Between Saturn and Enceladus," NASA,
118. "Science: The billion amp current that flows round Jupiter," N. Henbest, 1992, <https://www.newscientist.com/article/mg13318093-400-science-the-billion-amp-current-that-flows-round-jupiter/>
119. "The IO Dynamo," Dr. D Stern, 2001, <https://www.spod.gsfc.nasa.gov/Education/wio.html>
120. "Solar wind dynamic pressure and electric field as the main factors controlling Saturn's aurorae," F. J. Carey et al, 2005, <https://www.nature.com/articles/nature03333>
121. "The Role of Sunspots and Solar Winds in Climate Change," Scientific American, <https://www.scientificamerican.com/article/sun-spots-and-climate-change/>
122. "Where Are the Electrical Currents in the Enceladus Plume?" M. Zastrow, 2017, <https://eos.org/research-spotlights/where-are-the-electrical-currents-in-the-enceladus-plume>
123. "Cosmology in the plasma universe: an introductory exposition," H. Alven, 1990, <https://ieeexplore.ieee.org/document/45495/>
124. "Model of the Plasma Universe," H. Alven, 1986, <https://ieeexplore.ieee.org/document/4316614/>
125. "Two world systems revisited: a comparison of plasma cosmology and the Big Bang," E. J. Lerner, 2003, <https://ieeexplore.ieee.org/document/1265349/>
126. "Nikola Tesla," Wiki, https://en.wikiquote.org/wiki/Nikola_Tesla
127. "Teach it Right the first time," R. Krampf, 2018, <https://thehappyscientist.com/content/teach-it-right-first-time>
128. "Current generation in extragalactic jets by Cherenkov damping of magnetohydrodynamic waves," 1990, C. Luiz et al, <http://adsabs.harvard.edu/abs/1990ApJ...348...61J>
129. "Universe's highest Electric Current Found," P. Kronberg, 2011, New Scientist, <https://www.newscientist.com/article/mg21028174.900-universes-highest-electric-current-found/>
130. "The jet model for Sgr A*^{*}: radio and X-ray spectrum," H. Falke, S. Markoff, 2000, <https://arxiv.org/pdf/astro-ph/0102186.pdf>
131. "Evolution of force-free electric currents in the solar atmosphere," M. Karlicky, 1997, <http://adsabs.harvard.edu/abs/1997A%26A...318..289K>
132. "Currents in the Solar Atmosphere and a Theory of Solar Flares," H. Alfven, P. Carlqvist, 1967, <http://adsabs.harvard.edu/abs/1967SoPh....1..220A>
133. "Magnetic field and electric current density distribution in the geomagnetic tail, based on Geotail data ," P. L. Israelevich et al, 2001, <https://agupubs.onlinelibrary.wiley.com/doi/pdf/10.1029/2000JA900165>
134. "Electric Currents in the Solar Wind," P. Coleman Jr., 1975, <https://agupubs.onlinelibrary.wiley.com/doi/pdf/10.1029/JA080i034p04719>
135. "Science: The billion amp current that flows round Jupiter," N. Henbest, 1992, <https://www.newscientist.com/article/mg13318093-400-science-the-billion-amp-current-that-flows-round-jupiter/>
136. "The morphology of the ultraviolet Io footprint emission and its control by Io's location," J.C. Gerard et al, 2005, http://www.igpp.ucla.edu/public/mkivelso/refs/PUBLICATIONS/Gerard%20Io_footprint-JCG.pdf
137. "Electricity Measured Inside Space Tornadoes," C. Moskowitz, 2009, <https://www.space.com/6614-electricity-measured-space-tornadoes.html>

139. "The earth's ring current: Causes, generation, and decay." D. J. Williams, 1983, <http://adsabs.harvard.edu/abs/1983SSRv...34..223W>
140. "Thunderstorms, lightning, sprites and magnetospheric whistler-mode radio waves," D. Siingh et al., <https://arxiv.org/ftp/arxiv/papers/0906/0906.0429.pdf>
141. "Electric currents in space plasmas," Plasma Universe, https://www.plasma-universe.com/Electric_currents_in_space_plasmas
142. "The ring current, geomagnetic disturbance, and the Van Allen radiation belts," Syun-Ichi Akasofu, S. Chapman, 1961, <https://agupubs.onlinelibrary.wiley.com/doi/pdf/10.1029/JZ066i005p01321>
143. "Sprites, Blue Jets, and Elves: Optical Evidence of Energy Transport Across the Stratopause," M. Heavner et al., http://www.uas.alaska.edu/artsscience/naturalsciences/envs/faculty_staff/pubs/chapman.pdf
144. "High Voltage," Wiki, https://en.wikipedia.org/wiki/High_voltage
145. "Power Line Voltage," https://www.w8ji.com/power_line_voltage.htm
146. "Depolarization and Action Potential Duration in Cardiac Purkinje Fibers," M.Arita, B Surawicz., 2018, <http://circres.ahajournals.org/content/circresaha/33/1/39.full.pdf>
147. "Electrical Impedance of Cardiac Muscle," N. Sperelakis, T. Hoshiko, 2018, <http://circres.ahajournals.org/content/circresaha/9/6/1280.full.pdf>
148. "Action Currents, Internodal Potentials, and Extracellular Records.....W.Marks, G. Loeb, 1976, <https://pdfs.semanticscholar.org/bb00/967a365c81263abd9ac539f954131ae6f13c.pdf>
149. "The excitability of a single fibre in a Nerve Trunk," J. Lussier, W. Rushton, 1951, <https://physoc.onlinelibrary.wiley.com/doi/pdf/10.1113/jphysiol.1952.sp004734>
150. "Thin current sheets in space: where the action is," Swedish Institute of Space Physics, 2012, <https://phys.org/news/2012-08-thin-current-sheets-space-action.html>
151. "Magnetic Seismology of Interstellar Gas Clouds: Unveiling a Hidden Dimension," A. Tritesis, K. Tassis, <https://arxiv.org/ftp/arxiv/papers/1805/1805.03664.pdf>
152. "Current Sheet Formation in the Interstellar Medium," E. Zweibel. A. Brandenburg, 1997, <http://iopscience.iop.org/article/10.1086/303824/pdf>
153. "Detection of oppositely directed reconnection jets in a solar wind current sheet," M. Davis et al., 2006, https://drive.google.com/file/d/0ByRZ_FN_vit_SHNVVGZ5b2xoVWtqdFJMQ3FhTTh4UFdvNHY4/view
154. "Development of bifurcated current sheets in solar wind reconnection exhausts, R. Mistry et al., 2015, https://drive.google.com/file/d/0ByRZ_FN_vit_b1pfb1FGRDZSV2czdWxLaWdoRjMyV3RmZURV/view
155. "Current sheets in the Solar Corona," H. R. Strauss and N. F. Otani, 1987, http://articles.adsabs.harvard.edu/cgi-bin/nph-iarticle_query?1988ApJ...326..418S&data_type=PDF_HIGH&whole_paper=YES&type=PRINTER&filetype=.pdf
156. "Two Greek scientists map 3-D structure of gas clouds." Thema NewsRoom, 2018, <http://en.protothema.gr/two-greek-scientists-map-3-d-structure-of-gas-clouds-video/>
157. "150 years of Maxwell's equations," N. Engheta, 2015, <http://science.sciencemag.org/content/349/6244/136>
158. "Problem with Maxwell's Theory," Physics Stack Exchange, <https://physics.stackexchange.com/questions/150493/problem-with-maxwells-theory>
159. "Faraday paradox," Wiki, https://en.wikipedia.org/wiki/Faraday_paradox
160. "The inverse source problem for Maxwell's equations," R. Albanese, P.B. Monk, 2006, <http://iopscience.iop.org/article/10.1088/0266-5611/22/3/018/meta>
161. "Important Modeling Using New Electromagnetism," R. Distini, 2007, <http://www.distinti.com/docs/nethesis.pdf>
162. "New Electromagnetism: An improved model of Electromagnetism," F. Lorentz, 2016, <https://www.scienceforums.net/topic/93280-new-electromagnetism-an-improved-model-of-electromagnetism/>
163. "New Magnetism," R. Distini, 2003-2007, <http://www.distinti.com/docs/nm.pdf>
164. "The Secrets of $F = Qv \times B$," R. Distini, 2007, http://www.distinti.com/docs/the_secrets_of_qvxb.pdf
165. "New Gravity," R. Distini, 2000-2007, <http://www.distinti.com/docs/ng.pdf>
166. "Relativistic Jet," Wiki, https://simple.wikipedia.org/wiki/Relativistic_jet
167. "What is the Structure of Relativistic Jets in AGN on Scales of Light Days?" A. Wehrle et al., 2009, https://www.nrao.edu/A2010/whitepapers/rac/Wehrle_AGN_jets_GCT.pdf
168. "Heaviside's Method with Laplace Examples," <http://www.math.utah.edu/~gustafso/s2010/HeavisideCoverup2008.pdf>
169. "Vector Calculus," https://www.whitman.edu/mathematics/multivariable/multivariable_16_Vector_Calculus.pdf
170. "Imaginary Number," Wiki, https://en.wikipedia.org/wiki/Imaginary_number

171. "Eigenvalues and eigenvectors," Wiki, https://en.wikipedia.org/wiki/Eigenvalues_and_eigenvectors
172. "Is division of matrices possible? Stack Exchange, 2012, <https://www.stackexchange.com/questions/228229/is-division-of-matrices-possible>
173. "Commutative Property," Wiki, https://en.wikipedia.org/wiki/Commutative_property
174. "Vortrix Algebra ,", R. Distini, 2018, file:///C:/Users/Assistants/Downloads/VortrixAlgebra_V1p2.pdf
175. "Hawkins Electrical Guides," Wiki, https://en.wikipedia.org/wiki/Hawkins_Electrical_Guide#Google_Books_Volume_Links
176. " In 2017 the idea of Supersymmetry will either be seen to be true or die," G. Carr, The Economist, 2018, <http://www.theworldin.com/article/12781/so-long-susy?fsrc=scn/tw/wi/bl/ed/>
177. "Falsifying Λ CDM: Model-independent tests of the concordance model with eBOSS DR14Q and Pantheon," A Shafieloo et al., 2018, <https://arxiv.org/pdf/1804.04320.pdf>
178. "SENSEI: First Direct-Detection Constraints on sub-GeV Dark Matter from a Surface Run," M. Crisler et al., 2018, <https://arxiv.org/pdf/1804.00088.pdf>
179. "Edges result versus CMB and low-redshift constraints on ionization histories," S. Witte et al., 2018, <https://arxiv.org/pdf/1804.03888.pdf>
180. "Hubble Reveals Observable Universe", NASA, 2016, <https://www.nasa.gov/feature/goddard/2016/hubble-reveals-observable-universe-contains-10-times-more-galaxies-than-previously-thought>
181. " The Final Contradiction.,", Caltech, <http://theory.caltech.edu/people/jhs/strings/str115.html>
182. "A Universe of 2 Trillion Galaxies," L. Brooke, RAS, 2017, <https://phys.org/news/2017-01-universe-trillion-galaxies.html>
183. "Cosmic Dust Change our understanding of the birth of the Universe," R. Serensen, 2015, <http://sciencenordic.com/cosmic-dust-change-our-understanding-birth-universe>
184. "More than a trillion planets could exist beyond our Galaxy," E. Zachos, 2018, Nat Geo, <https://news.nationalgeographic.com/2018/02/exoplanets-discovery-milky-way-galaxy-spd>
185. "Wasp 104B is Darker than Charcoal," T. Mocnik et al, 2018, <https://arxiv.org/pdf/1804.05334.pdf>
186. "Seven Earth-Like Worlds Orbit a Star so Cool, You didn't know it Existed," N. Stockton, 2017, <https://www.wired.com/2017/02/7-earth-like-worlds-orbit-star-cool-didnt-know-existed/>
187. "Star smaller than Jupiter discovered," SPACE, 2017, <http://www.eniscuola.net/en/2017/07/18/star-smaller-jupiter-discovered/>
188. "How Cold Is a Y Dwarf Star? Even You Are Warmer, C. Choi, 2011, <https://www.space.com/12714-coldest-failed-stars-brown-dwarfs-wise.html>
189. " What would happen if you pulled a tiny chunk out of a neutron star?" E. Siegel, 2015, <https://medium.com/starts-with-a-bang/ask-ethan-79-the-tiniest-neutron-star-e5808e8fa328>
190. "Astrophysical Jets and Outflow," El. M. de Gouveia Dal Pino, <https://arxiv.org/ftp/astro-ph/papers/0406/0406319.pdf>
191. "The Size of the Longest Filaments in the Universe," S. Bharadwaj et al, 2004, <http://iopscience.iop.org/article/10.1086/382140/pdf>
192. "Mystery of the gigantic snake-like cosmic filament found 'pointing' at the supermassive black hole at the center of our galaxy," C. Macdonald, 2017, Daily Mail <http://www.dailymail.co.uk/sciencetech/article-5200221/Snake-like-filament-probing-galaxys-black-hole.html>
193. "The ghostly galaxy that is devoid of Black Matter," J. Parks, 2018, <http://astronomy.com/news/2018/03/the-galaxy-devoid-of-dark-matter>
194. "On the Gaia DR2 distances for Galactic Luminous Blue Variables," N. Smith et al., 2018, <https://arxiv.org/pdf/1805.03298.pdf>
195. "White Hole," Wiki, https://en.wikipedia.org/wiki/White_hole
196. "Brane," Wiki, <https://en.wikipedia.org/wiki/Brane>
197. "If gravitational waves exist are they technically just another form of light/electromagnetic wave?" Stack Exchange, <http://physics.stackexchange.com/questions/158385/if-gravitational-waves-exist-are-they-technically-just-another-form-of-light-ele>
198. "Schwarzschild radius," Wiki, https://en.wikipedia.org/wiki/Schwarzschild_radius
199. "First Observation of Gravitational Waves," Wiki, https://en.wikipedia.org/wiki/First_observation_of_gravitational_waves
200. "LIGO and Virgo Make First Detection of Gravitational Waves Produced by Colliding Neutron Stars," Caltech, 2017, <http://www.caltech.edu/news/ligo-and-virgo-make-first-detection-gravitational-waves-produced-colliding-neutron-stars-80082>

201. "Is Ligo guilty of Scientific Fraud?" O. Rossler, 2016, ResearchGate, https://www.researchgate.net/post/Is_LIGO_guilty_of_Scientific_Fraud
202. "A Critical analysis of Ligo's Recent Detection of Gravitational Waves Caused by Merging Black Holes," S. Crothers, Hadronic Journal, 2016, <http://vixra.org/pdf/1603.0127v5.pdf>
203. "Constant k-curvature hypersurfaces in Riemannian manifolds," F. Mahmoudi, 2010, <https://www.sciencedirect.com/science/article/pii/S0926224509001168>
204. "On the Logical Inconsistency of the Special Theory of Relativity." S. Crothers, 2017, https://www.researchgate.net/publication/314299910_On_the_Logical_Inconsistency_of_the_Special_Theory_of_Relativity
205. "Einstein's Lost Theory Describes a Universe Without a Big Bang," A. Aczel, 2014, <http://blogs.discovermagazine.com/crux/2014/03/07/einsteins-lost-theory-describes-a-universe-without-a-big-bang/#.WzplwtJKjct>
206. "Einstein's Evolving Universe: Beyond the Big Bang," M. Bartusiak, <https://www.nationalgeographic.com/magazine/2005/05/einstein-relativity-cosmology-space-time-big-bang/>
207. "Einstein's $E = mc^2$ mistakes," H. Ohanian, <https://arxiv.org/ftp/arxiv/papers/0805/0805.1400.pdf>
208. "Classical and Quantum Black Holes," J. M. Stewart, 2000, <http://iopscience.iop.org/article/10.1088/0264-9381/17/2/701/pdf>
209. "Former NASA physicist, Disputes Einstein's Relativity Theory," T. Macisaac, 2014, https://www.theepochtimes.com/former-nasa-physicist-disputes-einsteins-relativity-theory_739183.html
210. "Test of Einstein's Theory Confirms the Sun is losing Mass," R. Mandelbaum, 2018, <https://gizmodo.com/test-of-einsteins-theory-shows-the-sun-is-losing-mass-1822211120>
211. "Gravitational Deflection of Light and Microwaves," Significant Findings, <http://www.extinctionshift.com/SignificantFindings01.htm>
212. "Gauss's Law of Gravitation Correctly applied, Significant Findings, <http://www.extinctionshift.com/SignificantFindings02.htm>
213. "Principle of Reciprocity applied to the Einstein Ring Calculation...", Significant Findings, <http://www.extinctionshift.com/SignificantFindings03.htm>
214. "The Shapiro Delay," Significant Findings, <http://www.extinctionshift.com/SignificantFindings06B.htm>
215. "Clock Second of an Atomic Clock," Significant Findings, http://www.extinctionshift.com/SignificantFindings08_C.htm
216. "First observation with global network of optical atomic clocks aimed for a dark matter detection," P. Wisclo et al., 2018, <https://arxiv.org/pdf/1806.04762.pdf>
217. "A Constant Spectral Index for Sagittarius A* during Infrared/X Ray Intensity Variations," S. D. Hornstein et al., 2007, <https://arxiv.org/abs/0706.1782>
218. "The jet model for Sgr A*: radio and X-ray spectrum," H. Falcke & S. Markoff, 2001, <https://arxiv.org/abs/astro-ph/0102186>
219. "Milky Way's Black Hole is Shooting Particle Jets," C. Moskowitz, 2013, <https://www.scientificamerican.com/article/milky-way-black-hole-jet/>
220. "Hawking Radiation: A Violation of the Zeroth Law of Thermodynamics," P. R. Robitaille, 2018, <http://meetings.aps.org/Meeting/NES18/Session/D01.3>
221. "A Search for Invisible Axion Dark Matter with the Axion Dark Matter Experiment," N. Du et al., 2017., <https://arxiv.org/pdf/1804.05750.pdf>
222. "A Search for Dark Matter Annihilation in the Milky Way Halo," L. Chang et al., 2018, <https://arxiv.org/pdf/1804.04132.pdf>
223. "21-cm Fluctuations from Charged Dark Matter," J. Munoz, C. Dvorkin, & A. Loeb, 2018, <https://arxiv.org/pdf/1804.01092.pdf>
224. "SENSEI: First Direct-Detection Constraints on sub-GeV Dark Matter from a Surface Run," The SENSEI Collaboration., M. Crisler et al., 2018, <https://arxiv.org/pdf/1804.00088.pdf>
225. "Probing dark matter with star clusters: a dark matter core in the ultra-faint dwarf Eridanus II," F. Contenta et al, 2018, <https://academic.oup.com/mnras/article/476/3/3124/4875952>
226. "The Acceleration Relation in Galaxies and Scale Invariant Dynamics: Another Challenge for Dark Matter," A. Maede, 2018, <https://academic.oup.com/mnras/article/476/3/3124/487595>
227. "Dipolar dark matter and CMB B-mode polarization," S. Mahmoudi et al, 2018, <https://arxiv.org/pdf/1805.11172.pdf>
228. "Universe is not expanding as fast as was previously thought," H. Broden, 2015, <https://futurism.com/universe-is-not-expanding-as-fast-as-it-was-previously-thought/>

229. "No, The Universe Is Not Expanding at an Accelerated Rate, Say Physicists," B. Crew, 2016, <https://www.sciencealert.com/no-the-universe-is-not-expanding-at-an-accelerated-rate-say-physicists>
230. "Gaia DR2 Proper Motions of Dwarf Galaxies within 420 kpc: Orbits, Milky Way Mass, Tidal Influences, Planar Alignments, and Group Infall," T. K. Fritz et al, 2018, <https://arxiv.org/pdf/1805.00908.pdf>
231. "First Gaia Dynamics of the Andromeda System: DR2 Proper Motions, Orbits, and Rotation of M31 and M33," R. Van der Marel et al, 2018, <https://arxiv.org/pdf/1805.04079.pdf>
232. "A whirling plane of satellite galaxies around Centaurus A challenges cold dark matter cosmology," O. Muller et al, 2018, <https://arxiv.org/pdf/1802.00081.pdf>
233. "Modified Newtonian Dynamics," Wiki, https://en.wikipedia.org/wiki/Modified_Newtonian_dynamics
234. "Spiral Galaxy Rotation Curves Without Dark Matter or MOND – Two Conjectures," T. Biswas, 2018, <https://arxiv.org/pdf/1801.09304.pdf>
235. "Can dark matter vanquish a rival theory?" A. Cho, 2017, <http://www.sciencemag.org/news/2017/01/can-dark-matter-vanquish-rival-theory>
236. "More Evidence Against Dark Matter," A. Cho, 2011, <http://www.sciencemag.org/news/2011/02/more-evidence-against-dark-matter>
237. "The Man who's Trying To Kill dark Matter," Wired, N. Wolchover, 2017, <https://www.wired.com/2017/01/case-dark-matter/>
238. "Hubble and Shapley- Two Early Giants of Observational Cosmology," S. van den Bergh et al., <https://arxiv.org/ftp/arxiv/papers/1110/1110.2445.pdf>
239. Edwin Powell Hubble - The man who discovered the cosmos," Hubble News, https://www.spacetelescope.org/about/history/the_man_behind_the_name/
240. "Niels Bohr," Wiki, https://en.wikiquote.org/wiki/Niels_Bohr
241. "History of Quantum Mechanics," Wiki, https://en.wikipedia.org/wiki/History_of_quantum_mechanics
242. Davisson-Germer Experiment, <http://hyperphysics.phy-astr.gsu.edu/hbase/quantum/DavGer2.html>
243. "On the Units of Planck's Constant Revisited," L. Gardi., 2018, <http://www.theomparticle.com/UnitsOfPlanck/On-Plancks-Constant-Revisited%203.pdf>
244. "±Water: Demonstration of Water Properties, Depending on its Electrical Potential," Y. Pivovarenko, (World Journal of Applied Physics) 2018, <http://article.sciencepublishinggroup.com/pdf/10.11648.j.wjap.20180301.12.pdf>
245. "Numerical Estimation of the Complex Refractive Indexes by the Altitude Depending on Wave Frequency in the Ionized Region of the Earth Atmosphere for Microwaves Information and Power Transmissions," D.C.Nguyen et al., 2016, <http://www.jpier.org/PIERM/pierm52/03.16042707.pdf>
246. "Tired Light and Type Ia Supernovae Observations," H. Holushko, <http://bourabai.kz/articles/snt.pdf>
247. "Possible Implications of Self-Similarity for Tornadogenesis and Maintenance," P. Belik et al., 2018, <https://arxiv.org/pdf/1806.04505.pdf>
248. "What's My Problem," Sf. R Careaga, 2015,
249. "Drake Equation Tutorial," J. Plaxco, Astronomical Adventures, 2007, http://www.astrodigital.org/astronomy/drake_equation.html
250. "Life in the Universe? Almost certainly, Intelligence: Maybe not," Harvard Gazette, A. Powell, 2009, <https://news.harvard.edu/gazette/story/2009/05/life-in-the-universe-almost-certainly-intelligence-maybe-not/>
251. "Ludwig Boltzmann," Wiki, https://en.wikipedia.org/wiki/Ludwig_Boltzmann#Physics
252. "Photoelectric Effect," Wiki, https://en.wikipedia.org/wiki/Photoelectric_effect
253. "Heuristic View of Light," A. Einstein, 1905, <https://einsteinpapers.press.princeton.edu/vol2-trans/100>
254. "Albert Einstein: His Annus Mirabilis 1905*," V. Singh, 2006, <https://arxiv.org/pdf/physics/0701240.pdf>
255. "Black-Body Radiation," Wiki, https://en.wikipedia.org/wiki/Black-body_radiation
256. "Photovoltaic effect," Wiki, https://en.wikipedia.org/wiki/Photovoltaic_effect
257. "Electric Currents in Space Plasma," Plasma Universe.com https://www.plasma-universe.com/Electric_currents_in_space_plasmas
258. "Dynamic and Stagnating Plasma Flow Leading to Magnetic-Flux-Tube Collimation," S. You et al., 2005, <https://journals.aps.org/prl/abstract/10.1103/PhysRevLett.95.045002>
259. "Quantum-Mechanical Fundamentals of Lasers," Laser Physics (hardcover) M. Eichhorn, 2014, <https://www.springer.com/cda/content/document/cda.../9783319051277-c1.pdf>
260. "Case Study: Lasers." Institute of Physics (the "Institute") and IOP Publishing 2014. http://www.iop.org/cs/page_43644.html

261. "Internet Protocol," Wiki, https://en.wikipedia.org/wiki/Internet_Protocol
262. "Semiconductors," Wiki, <https://en.wikipedia.org/wiki/Semiconductor>
263. "Quantum tunnelling," Wiki, https://en.wikipedia.org/wiki/Quantum_tunnelling
264. "Dielectric," Wiki, <https://en.wikipedia.org/wiki/Dielectric>
265. "A quantum speed limit: how fast does quantum information flow through a lattice?" M. Francis, 2012, <https://arstechnica.com/science/2012/01/experiment-shows-speed-limit-for-interactions-in-quantum-systems>
266. "Physicists Just Showed that Quantum Entanglement is a Physical Reality," D.Galeon,S. Marquart, 2017, <https://futurism.com/this-discovery-could-transform-our-understanding-of-the-cosmos/>
267. "Entanglement is Spooky, but not Action at a Distance." T. Siegfried, 2016, <https://www.sciencenews.org/blog/context/entanglement-spooky-not-action-distance>
268. "Quantum "spooky action at a distance" travels at least 10,000 times faster than light," B. Dodson, 2013, <https://newatlas.com/quantum-entanglement-speed-10000-faster-light/26587/>
269. "Physicists find quantum coherence and quantum entanglement are two sides of the same coin," L. Zyga, 2015, <https://phys.org/news/2015-06-physicists-quantum-coherence-entanglement-sides.html>
270. "Quantum electrodynamics," Wiki, https://en.wikipedia.org/wiki/Quantum_electrodynamics#Probability_amplitudes
271. "Why is Gravity so Different than other Sources?" S. Emre, 2013, <https://sureshemre.wordpress.com/2013/12/14/why-is-gravity-so-different-from-other-forces/>
272. "How do they keep track of the particles in the LHC?" K. Kershner, 2014, <https://science.howstuffworks.com/how-track-particles-lhc.htm>
273. "New sub atomic particle confounds theory," J. Hogan, 2003, <https://www.newscientist.com/article/dn3687-new-sub-atomic-particle-confounds-theory/>
274. "Gyrokinetic particle simulations of toroidal momentum transport," I. Holoda and Z. Lin, 2008, <http://phoenix.ps.uci.edu/zlin/bib/holod08.pdf>
275. " In 1928 one physicist Accidentally Predicted Antimatter," A. Thompson, 2017, <https://www.popularmechanics.com/science/a27049/in-1928-one-physicist-accidentally-predicted-antimatter/>
276. " The Discovery of Quarks," M. Riordan, 1992, <http://science.sciencemag.org/content/256/5061/1287?ck=nck>
277. "Magnetohydrodynamics," Wiki, <https://en.wikipedia.org/wiki/Magnetohydrodynamics>
278. "NASA Spacecraft Discovers New Magnetic Process in Turbulent Space," M. Johnson-Groh, NASA, 2018, <https://www.nasa.gov/feature/goddard/2018/nasa-spacecraft-discovers-new-magnetic-process-in-turbulent-space>
279. "Collapse of neutral current sheet and reconnection at micro-scales," I. F. Shaikhislamov, <https://arxiv.org/ftp/arxiv/papers/1711/1711.11284.pdf>
280. "Freezing-in condition for a magnetic field and current sheets in plasma," S. I Syrovatskii, 1978, <http://adsabs.harvard.edu/full/1978Ap%26SS..56....3S>
281. "Plasma physics, space research and the origin of the solar system," H. Alfvén, 1970, https://www.nobelprize.org/nobel_prizes/physics/laureates/1970/alfven-lecture.pdf
282. "Combining Quantum Electrodynamics and electron correlation," I. Lindgren et al, 2013, <http://fy.chalmers.se/~f3ail/Publications/Jakobsberg.pdf>
283. "Testing non-commutative QED, constructing non-commutative MHD," Z. Guralnik et al, <https://www.sciencedirect.com/science/article/pii/S0370269301009868>
284. "Magnetic reconnection: from MHD to QED," S.V. Bulanov, 2016, <https://arxiv.org/abs/1610.01873>
285. "75th Anniversary of 'Existence of Electromagnetic-Hydrodynamic Waves,'" A. J. B. Russell, 2018, <https://arxiv.org/pdf/1711.04876.pdf>
286. "Generalised global symmetries and magnetohydrodynamic waves in a strongly interacting holographic plasma," S. Grozdanov, N. Poovuttikul, 2018, <https://arxiv.org/pdf/1707.04182.pdf>
287. "Coral Castle," Wiki, https://en.wikipedia.org/wiki/Coral_Castle
288. "Investigating Coral Castle," G. Hancock, 2014, <https://grahamhancock.com/carrd4/>
289. "Mystery of the Coral Castle Explained," B. Radford, 2018, <https://www.livescience.com/41075-coral-castle.html>
290. "Zero point Energy," Wiki, https://en.wikipedia.org/wiki/Zero-point_energy
291. "Double Helix - (disambiguation,") Wiki, [https://en.wikipedia.org/wiki/Double_helix_\(disambiguation\)](https://en.wikipedia.org/wiki/Double_helix_(disambiguation))
292. "Electrical Wire Properties Linked to Cancer," California Institute of Technology, 2018, <https://www.sciencedaily.com/releases/2018/06/180618113017.htm>
293. "Magnetic Current," E. Leedskalnin, 1945, http://www.pateo.nl/HTML/PD/TP/Magnetic_Current_by_Edward_Leedskalnin.pdf

294. "Double Helical Magnetic Interaction." M. Emery, 2005-2018, <http://www.leedskalnin.com/>
295. "The Double Helix Theory of the Magnetic Field," F. B Tombe, 2006, http://www.leedskalnin.com/the_double_helix_theory_of_the_magnetic_field.pdf
296. "New kind of metal in the deep Earth: Iron oxide undergoes transition under intense pressures and temperatures," Carnegie Institution, 2011, <https://www.sciencedaily.com/releases/2011/12/111219112216.htm>
297. "Dynamic Theory of Gravity" Inventions and Experiments of Nikola Tesla, 1938, <https://teslaresearch.jimdo.com/dynamic-theory-of-gravity/>
298. "VLT Makes Most Precise Test of Einstein's General Relativity Outside Milky Way," T. Collett, 2018, ESO, <http://www.eso.org/public/news/eso1819/>
299. "Observations of the missing baryons in the warm-hot intergalactic medium," F. Nicastro et al, 2018,, <https://www.nature.com/articles/s41586-018-0204-1>
300. "The Protected Dark and Baryonic Ellipsoidal Structure of 20 Clash Galaxy Clusters," K.I Umetsu et al, 2018, <https://arxiv.org/pdf/1804.00664.pdf>
301. "Electrons' magnetic interactions isolated at long last," T. Commissariat, 2014, <https://physicsworld.com/a/electrons-magnetic-interactions-isolated-at-long-last/>
302. "Has the Photon both gravitational and inertial Mass?" C. J.Soderquist, 2014, Stack Exchange, <https://physics.stackexchange.com/questions/127212/has-the-photon-both-gravitational-and-inertial-mass>
303. "Schrödinger equation," Wiki, https://en.wikipedia.org/wiki/Schr%C3%B6dinger_equation
304. "Platonic Solid," Wiki, https://en.wikipedia.org/wiki/Platonic_solid
305. "Review of Electrogravitics & Electrokinetics Propulsion," T Valone, 2015 https://www.researchgate.net/publication/275336156_Review_of_Electrogravitics_Electrokinetics_Propulsion
306. "Electroweak Theory," C. Sutton, <https://www.britannica.com/science/electroweak-theory>
307. "The Nobel path to a unified electroweak theory," 2009, <https://cerncourier.com/the-nobel-path-to-a-unified-electroweak-theory/>
308. "The Future World Energy Crisis, UK Essays, 2015, <https://www.ukessays.com/essays/environmental-sciences/the-future-world-energy-crisis-environmental-sciences-essay.php>
309. "Free Energy," Wiki, https://en.wikipedia.org/wiki/Free_energy
310. "Famed Scientist, on Eve of 76th Birthday, Says He Has Succeeded in Harnessing 'Penetrating Rays' to Operate Small Motive Device," John J. A. O'Neill, 21st C Books, <http://www.tfcbooks.com/tesla/1932-07-10.htm>
311. "The Problem of Increasing Human Energy..." Nikola Tesla, 1900, 21st C Books, Century Illustrated Mag, <http://www.tfcbooks.com/tesla/1900-06-00.htm>
312. "Thin current sheets in space: where the action is," 2012, Swedish Institute of Space Physics, <https://phys.org/news/2012-08-thin-current-sheets-space-action.html>
313. "Chaos in Magnetic Flux Ropes," W, Gekelman et al, 2014, IOP Publishing Ltd. ["http://iopscience.iop.org/article/10.1088/0741-3335/56/6/064002](http://iopscience.iop.org/article/10.1088/0741-3335/56/6/064002)
314. "The plasma-sheath boundary: its history and Langmuir's definition of the sheath edge," J. E. Allen, 2008, IOP Publishing Ltd. <http://iopscience.iop.org/article/10.1088/0963-0252/18/1/014004>
315. "Thermodynamics, the 4 Laws," 2017, <http://physicsforidiots.com/physics/thermodynamics/>
316. "Boyle's Law," Wiki, https://en.wikipedia.org/wiki/Boyle%27s_law
317. "Ideal Gas," Wiki https://en.wikipedia.org/wiki/Ideal_gas#Ideal_gas_law
318. "Joule-Thomson effect" Wiki, https://en.wikipedia.org/wiki/Joule%E2%80%93Thomson_effect#Joule's_second_law
319. "Newton's Law of Motion," Wiki, https://en.wikipedia.org/wiki/Newton%27s_laws_of_motion
320. "Euler's Law of Motion," Wiki, https://en.wikipedia.org/wiki/Euler%27s_laws_of_motion
321. "Faraday's Law of Induction," Wiki, https://en.wikipedia.org/wiki/Faraday%27s_law_of_induction
322. "Maxwell's equations," Wiki, https://en.wikipedia.org/wiki/Maxwell%27s_equations
323. "Lenz's Law, Wiki, https://en.wikipedia.org/wiki/Lenz%27s_law
324. "Kirchhoff's circuit laws," Wiki, https://en.wikipedia.org/wiki/Kirchhoff%27s_circuit_laws
325. "Ampère's circuital law," Wiki, https://en.wikipedia.org/wiki/Amp%C3%A8re%27s_circuital_law
326. "Hysteresis," 1998, <https://www.britannica.com/science/hysteresis>
327. "Metrical Dimensional Relations of the Aether:," J. Zerbin, <http://www.gestaltreality.com/energy-synthesis/eric-dollard/metrical-dimensional-relations-of-the-aether-by-e-p-dollard>